

~60min

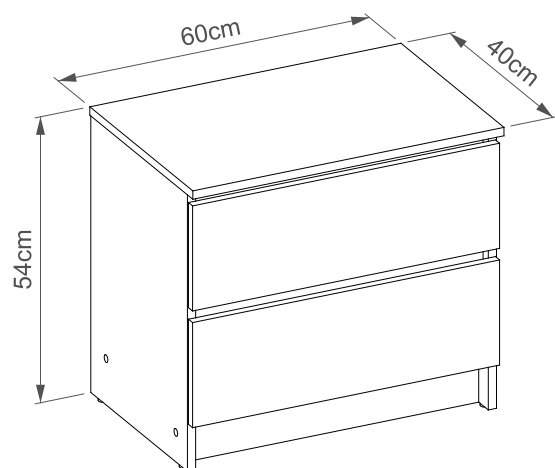

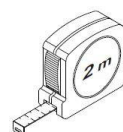

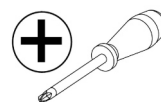
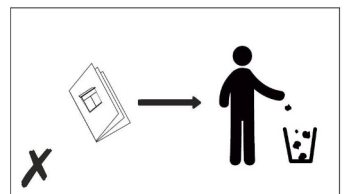
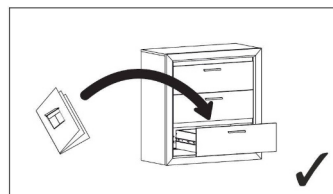
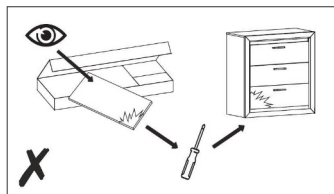
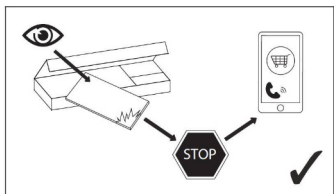
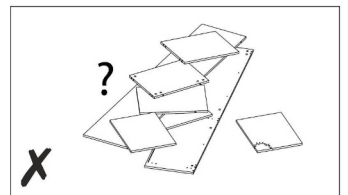
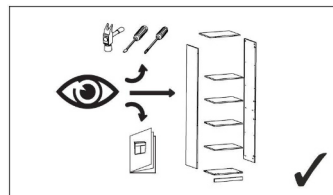
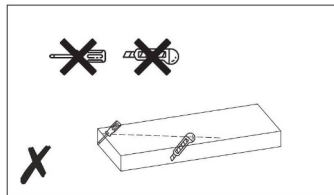
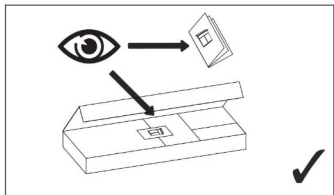
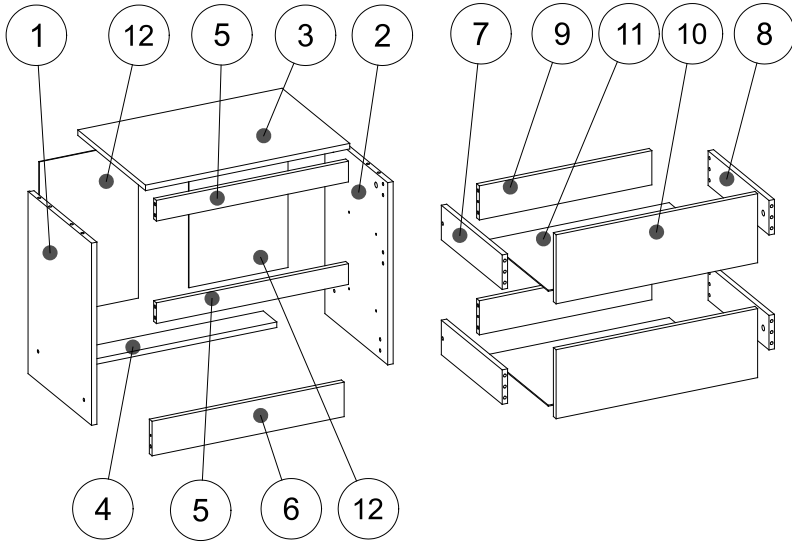

1	528x375x16mm	1
2	528x375x16mm	1
3	604x400x16mm	1
4	568x80x16mm	1
5	568x60x16mm	2
6	568x100x16mm	1
7	360x100x16mm	2
8	360x100x16mm	2
9	510x99x16mm	2
10	596x200x16mm	2
11	365x540x3mm	2
12	456x293x3mm	2

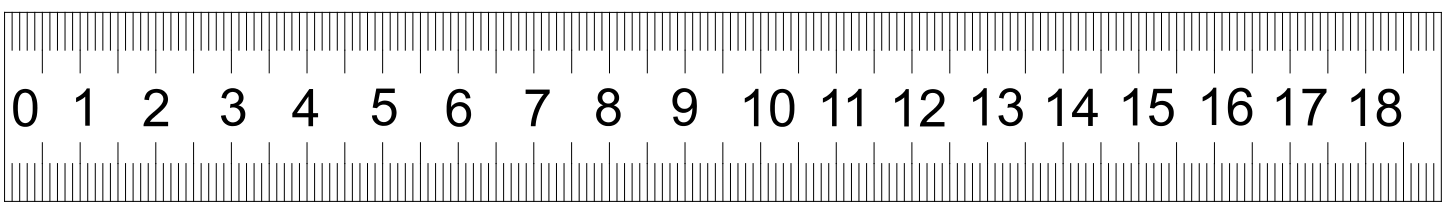
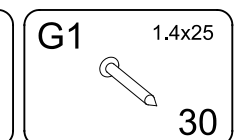
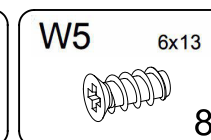
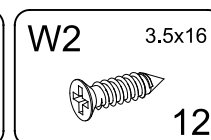
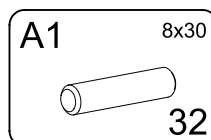
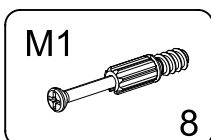
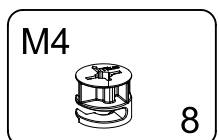
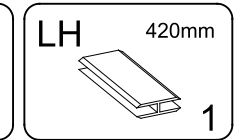
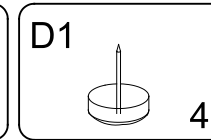
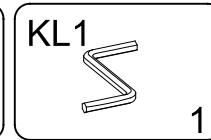
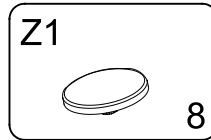
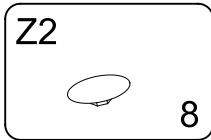
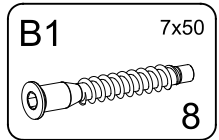
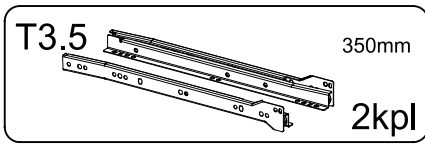

# ▶ 1

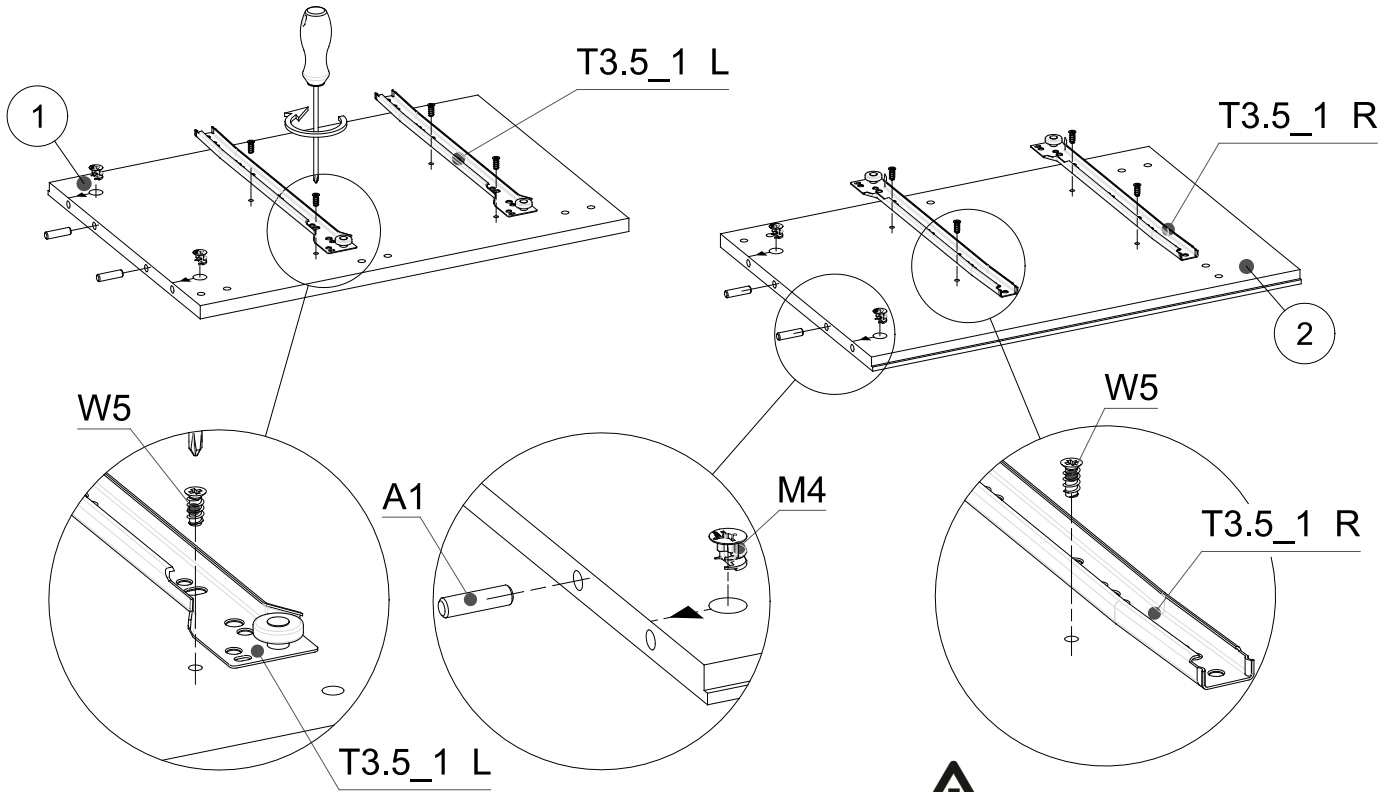
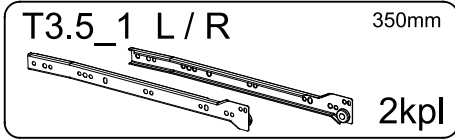
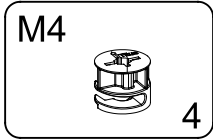
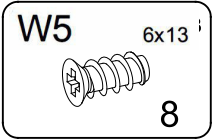
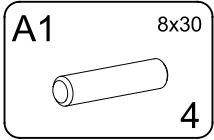
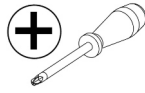

**T3.5\_1 R**

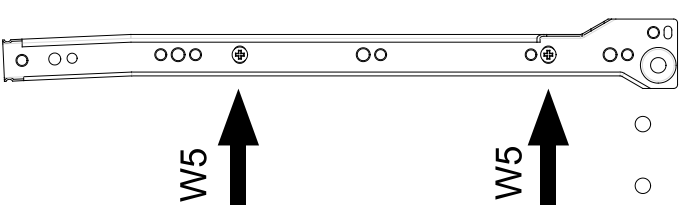

**T3.5\_1 L**

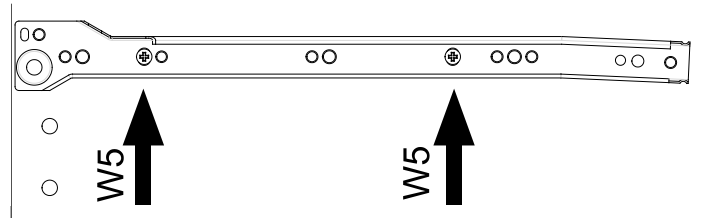

# ▶ 2

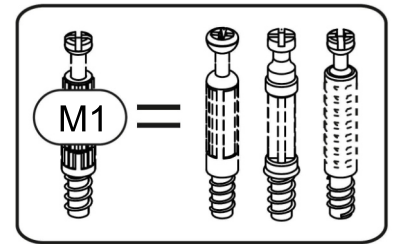
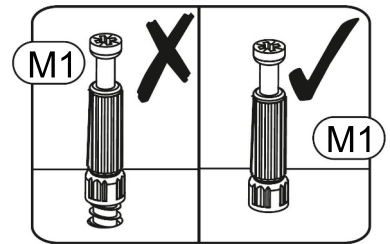
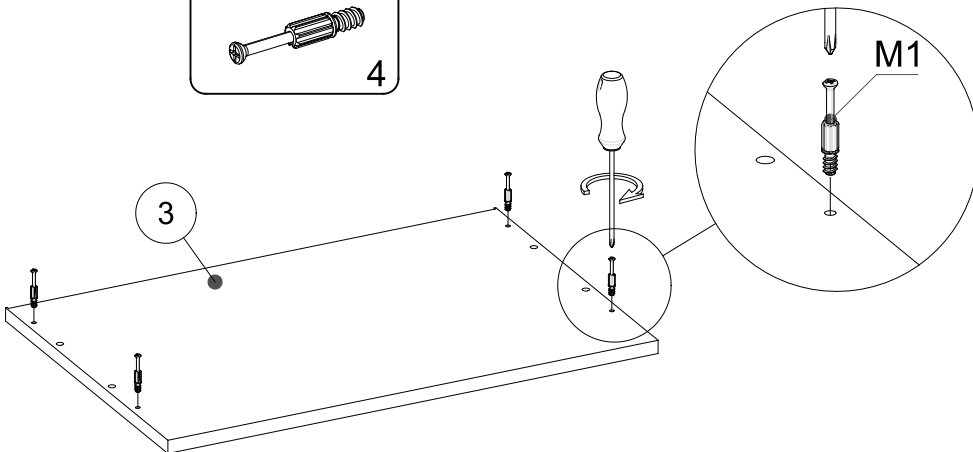
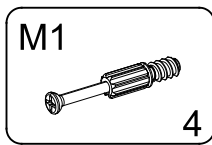
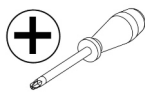

# ▶ 3

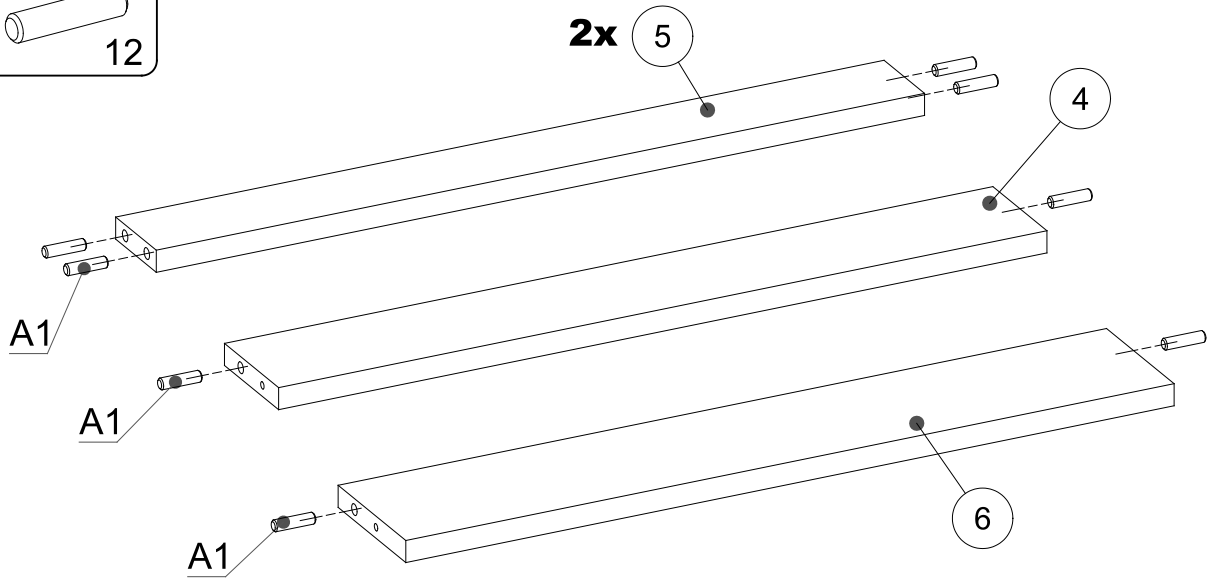
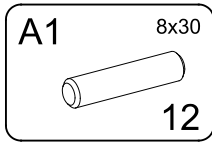

# ▶ 4

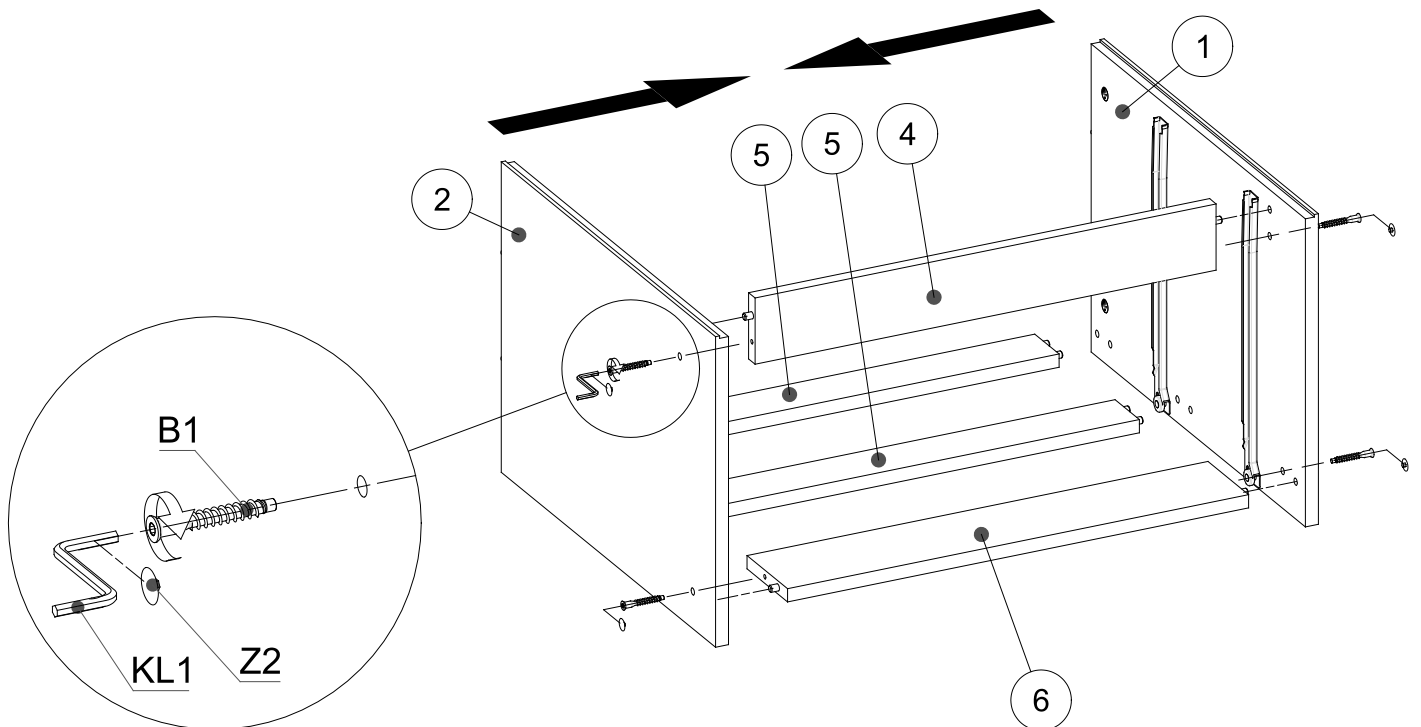
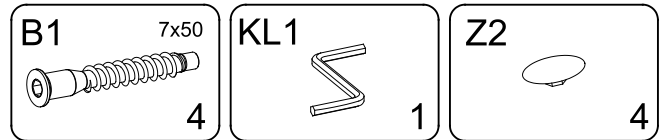
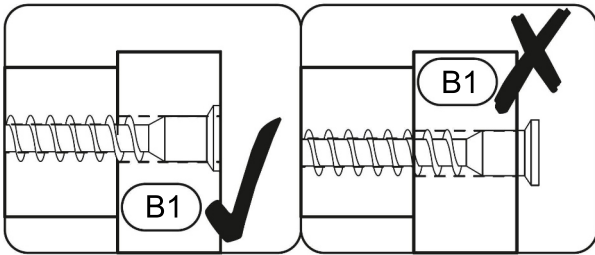

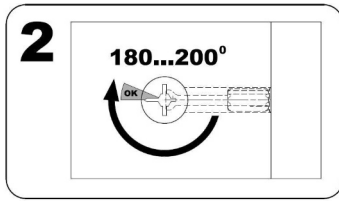
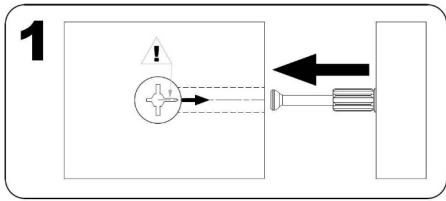

**5**

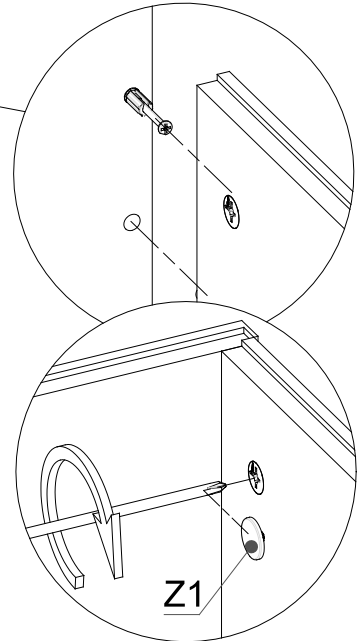
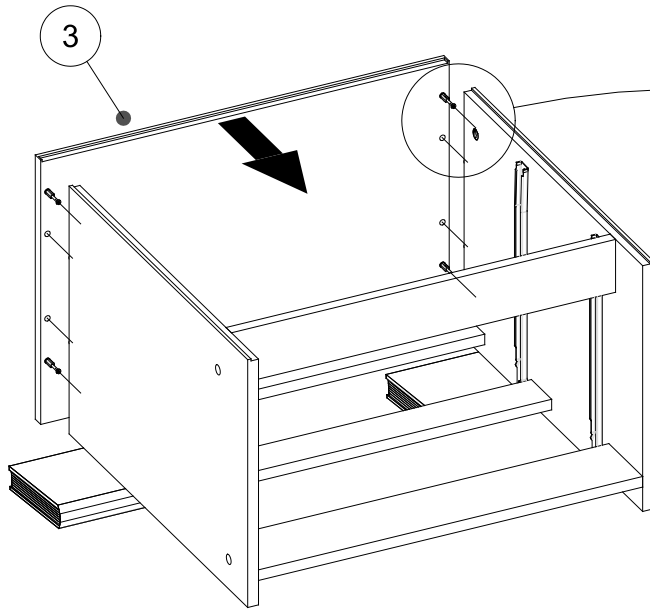
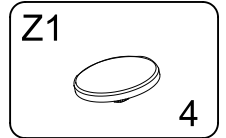
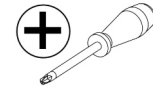

**6**

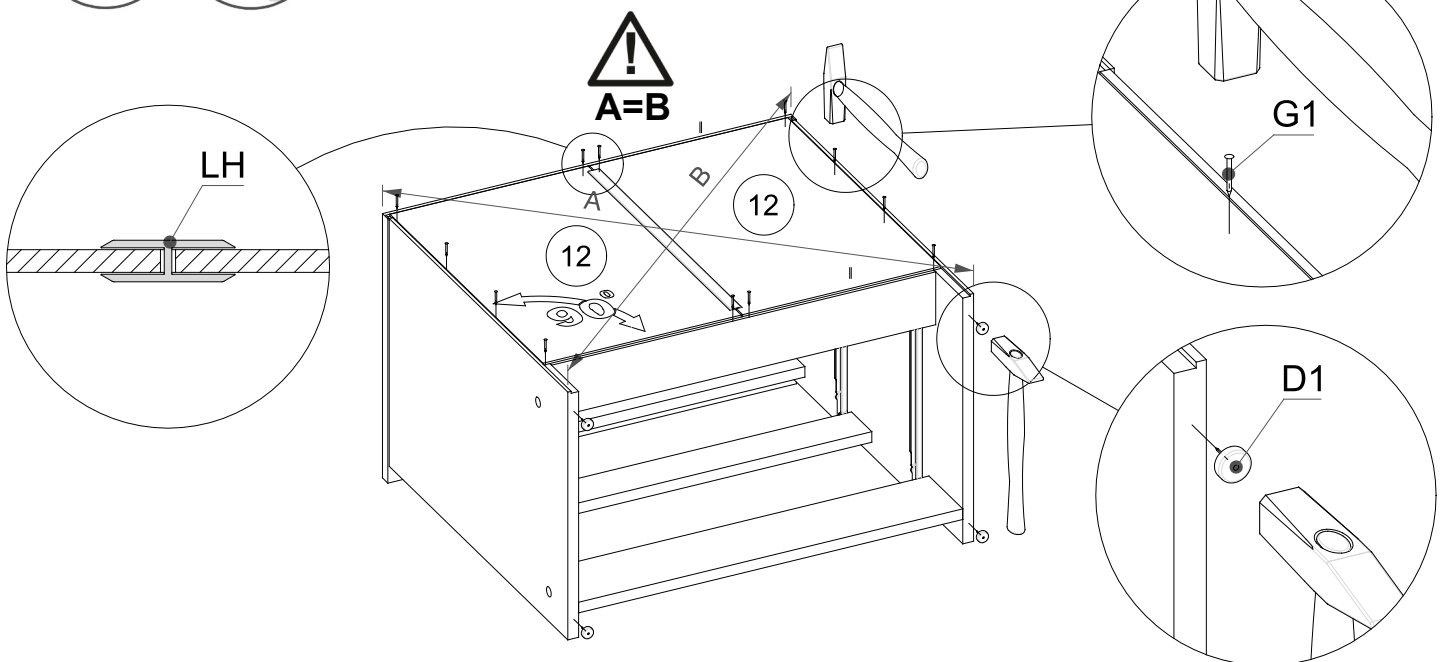
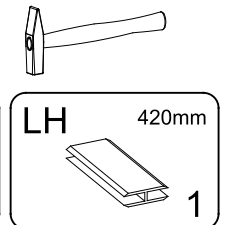
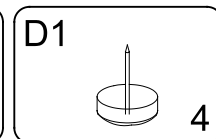
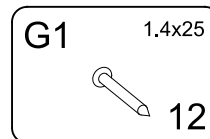
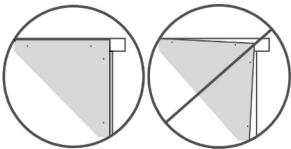

# ▶ 7

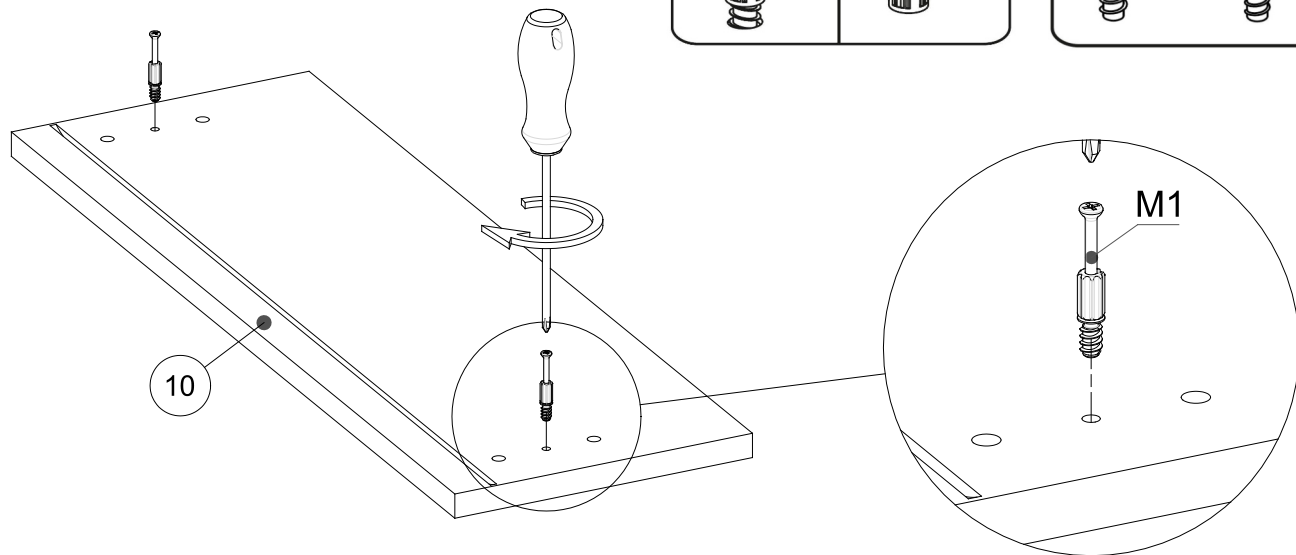
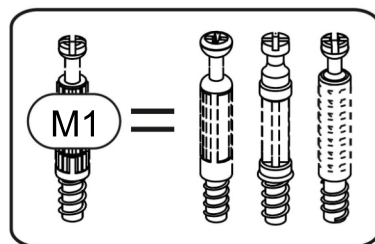
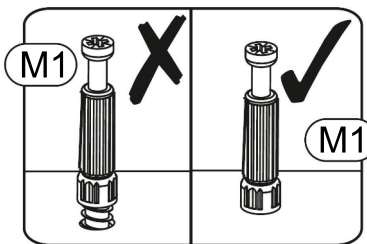
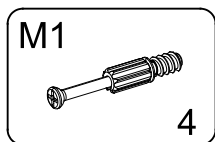
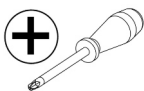

# ▶ 8

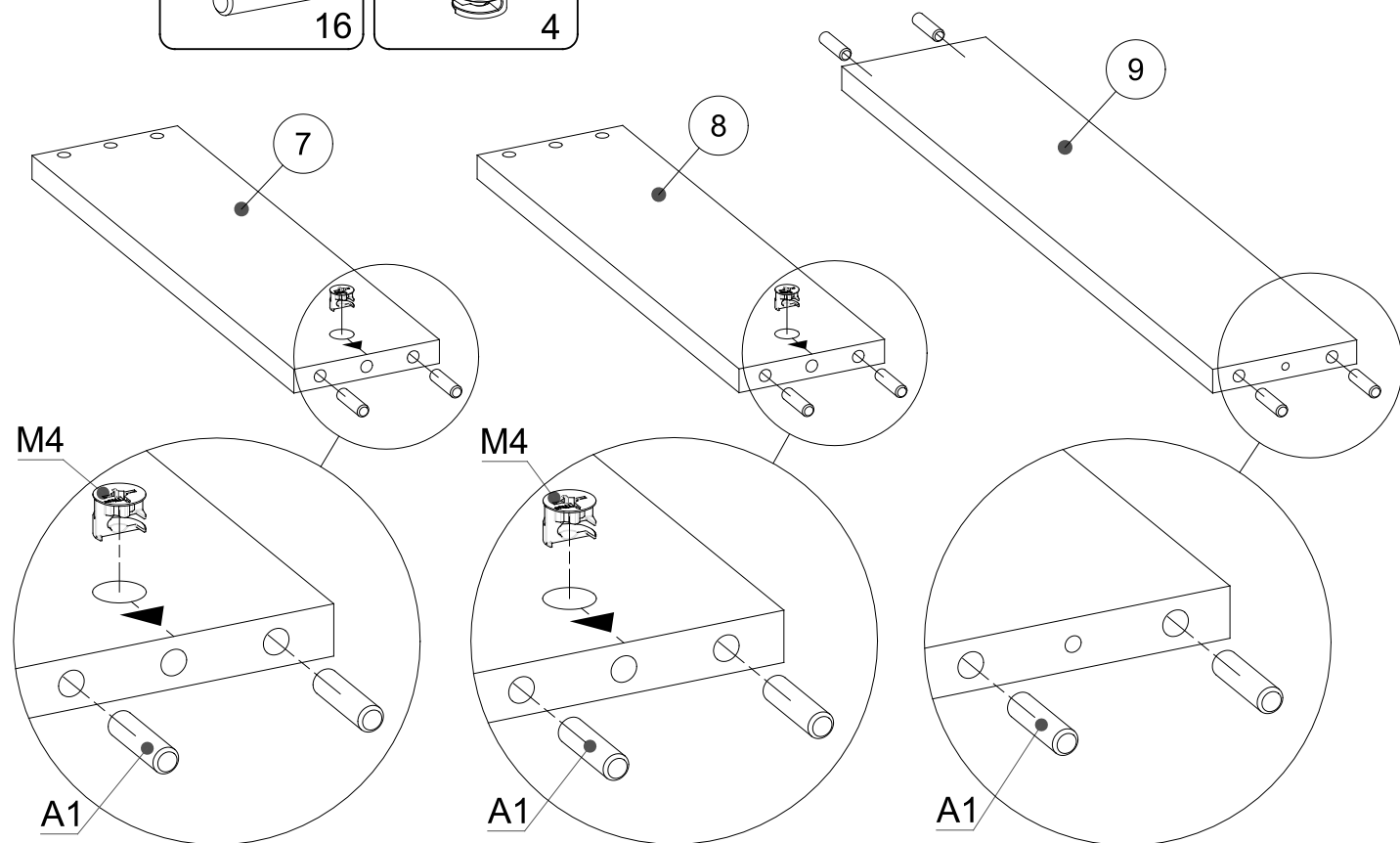
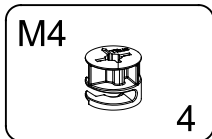
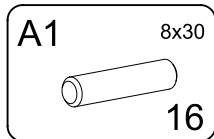

# ▶ 9

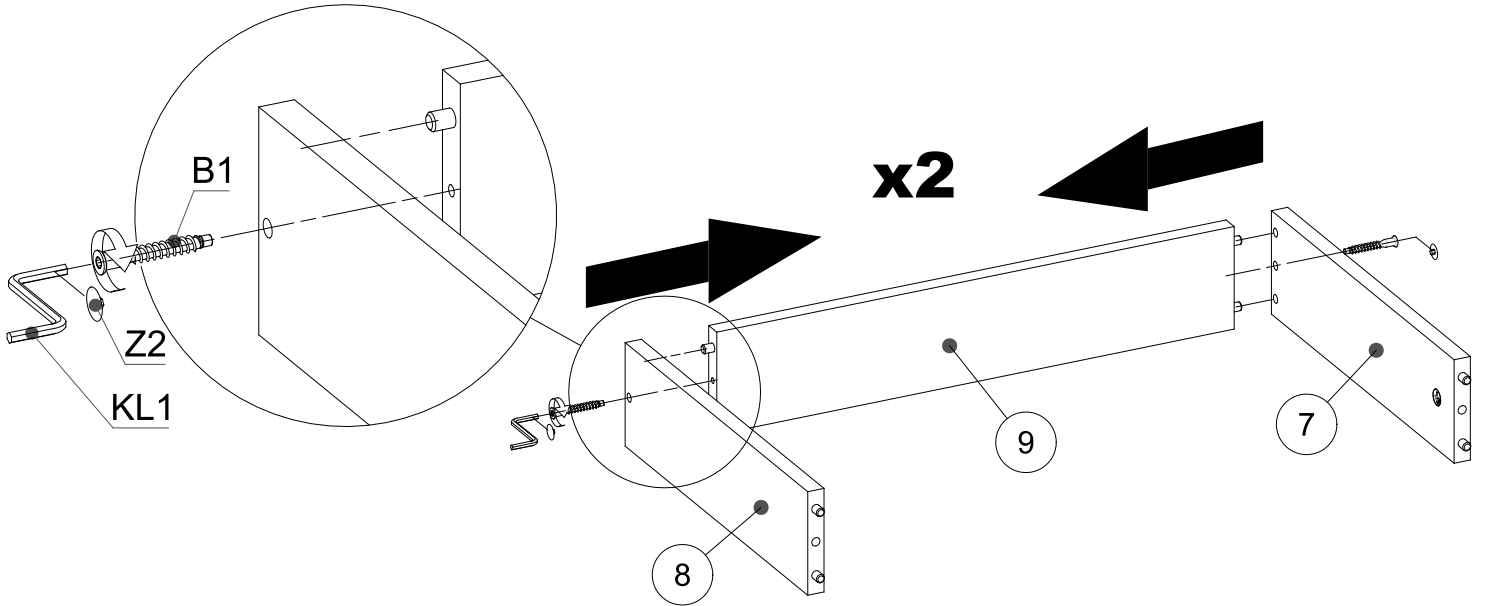
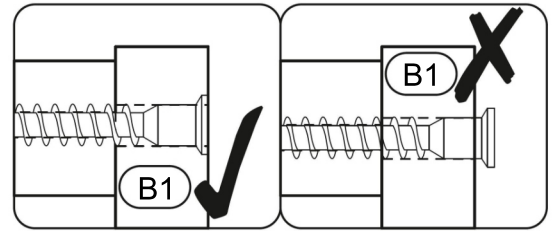
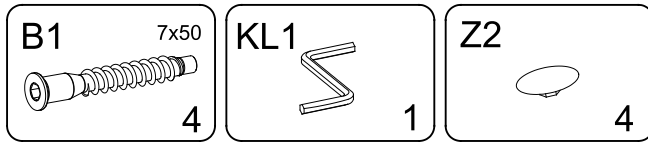

# ▶ 10

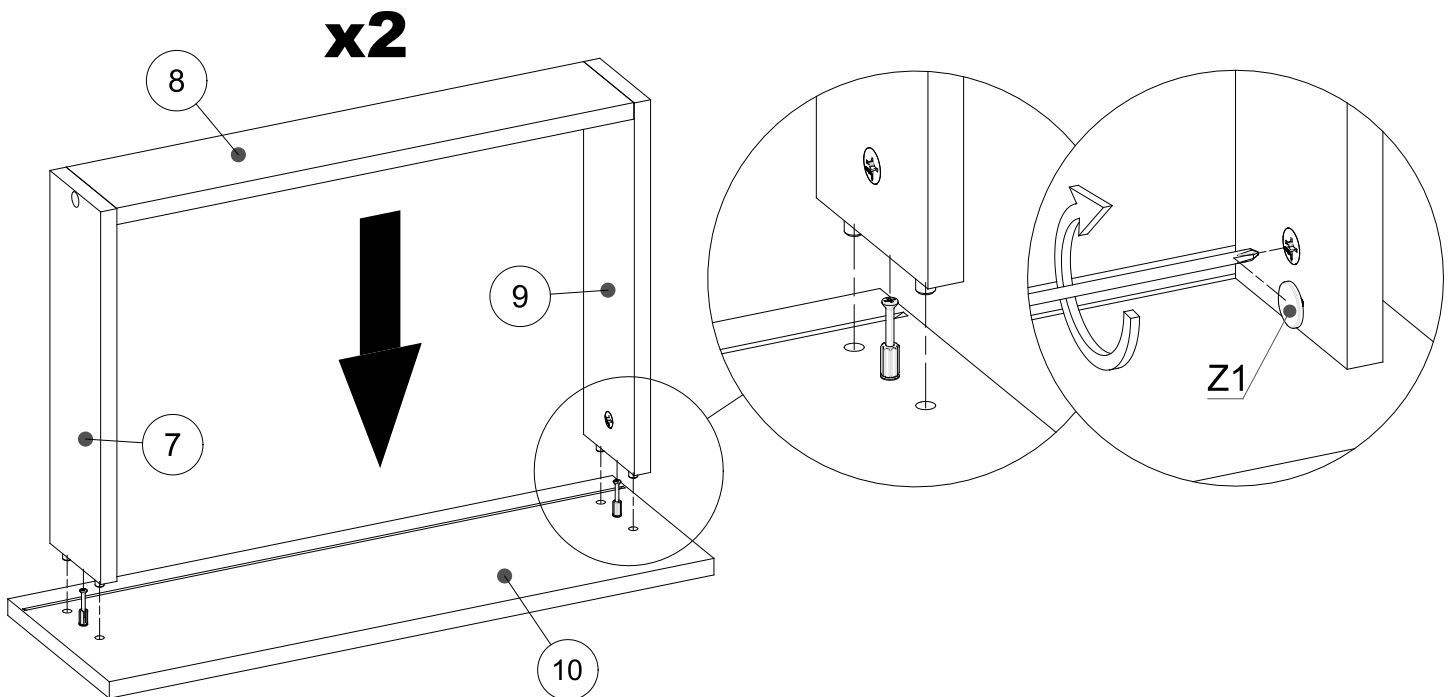
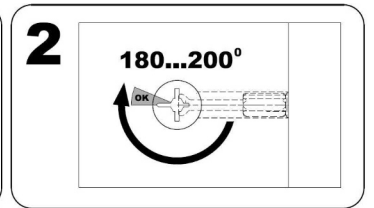
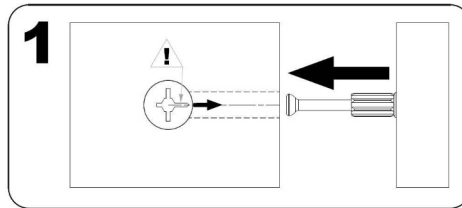
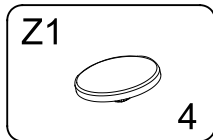
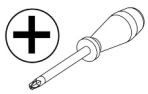



# ▶ 11

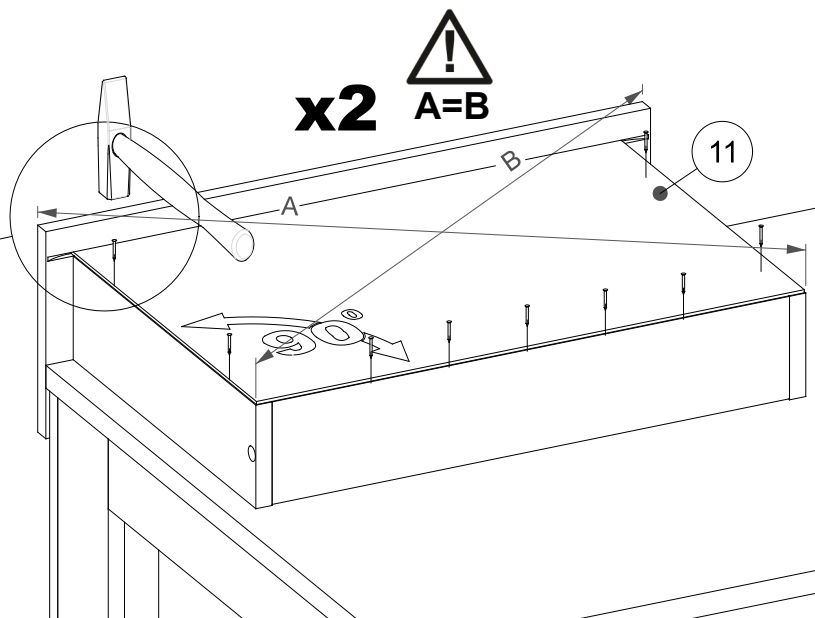
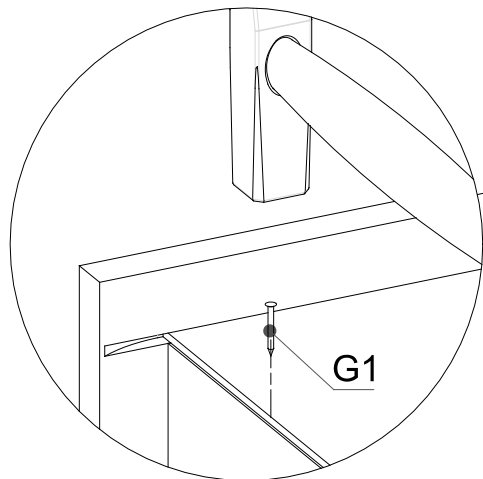
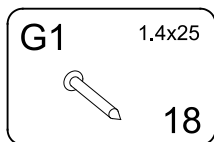

# ▶ 12

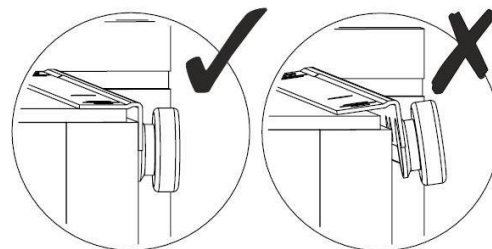
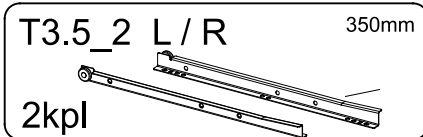
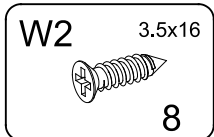
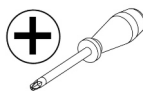

T3.5\_2 L

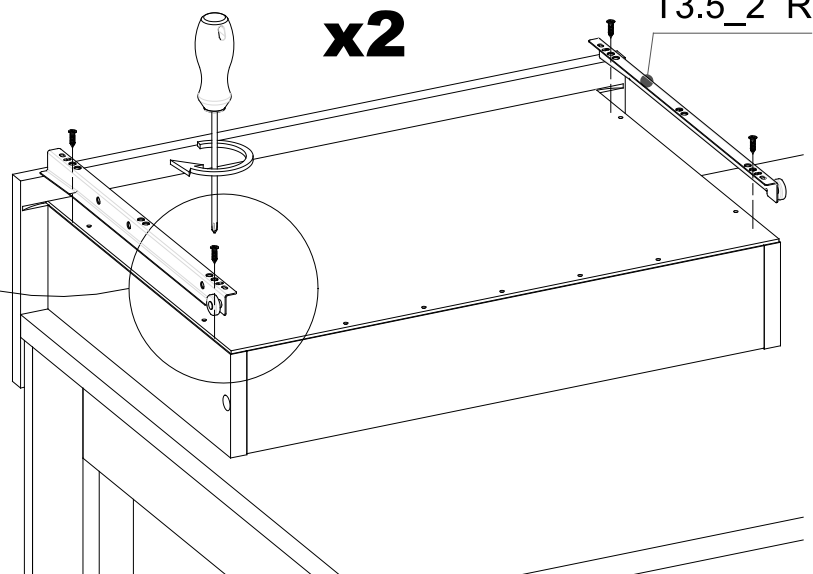
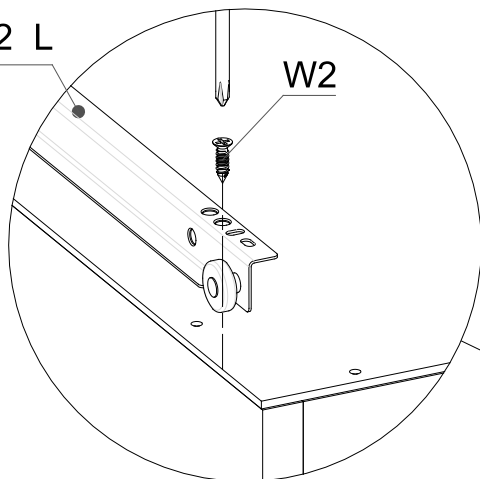

# ▶ 13

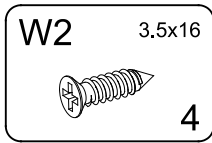
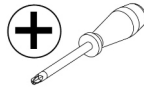

max. 20kg  
max. 3kg

