

MM

260

250

240

230

220

210

200

190

180

170

160

150

140

130

120

110

100

90

80

70

60

50











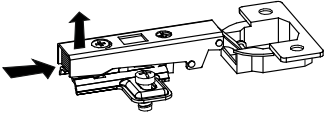

40

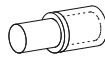
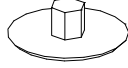
30

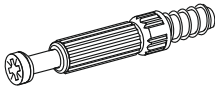
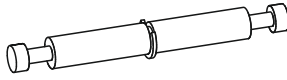
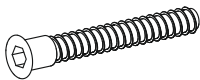
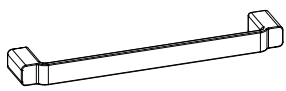
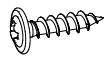
20

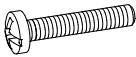
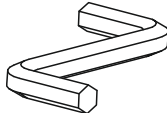
10

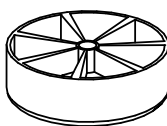
0

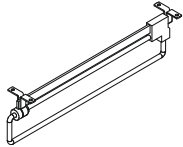
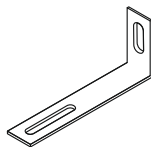
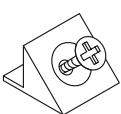
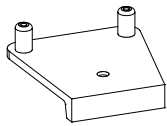
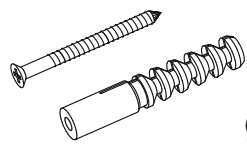
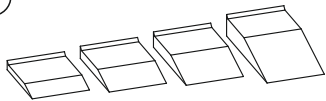
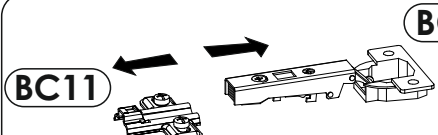
A1 8 x 35 mm x16 	A2 8 x 45 mm x4 	BC11 + BC12 x7 
C2 5 x 13 mm x14 	D2 x16 	E0 Ø16 x19 
E1 15 x 12 mm x22 	F1 6 x 34 mm x14 	F3 7 x 64 mm x4 
G1 7 x 50 mm x4 	H1 L-174 mm x1 	I2 4 x 16 mm x6 
I3 3.5 x 22 mm x4 	K8 4 x 25 mm x2 	M x1 
N0 3 x 13 mm x1 	N1 3 x 16 mm x5 	O1 x4 
P0 x2 Ø5 	P7 x1 	Q9 x2 
R4 x14 	R5 x1 	S13 x2 Ø8 
Z x1 	BC11 ↔ BC12 	



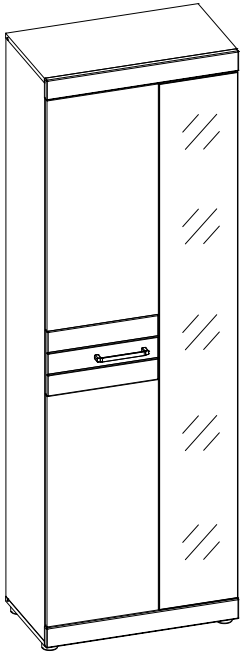

1	1956	360	16	x1	2/2
2	1956	360	16	x1	2/2
3	650	360	16	x1	1/2
4	650	360	16	x1	1/2
5	616	340	16	x1	1/2
6	650	70	19	x1	1/2
7	650	70	19	x1	1/2
8	376	807	16	x1	1/2
9	376	228	19	x1	1/2
10	376	807	16	x1	1/2
11	1842	266	20	x1	2/2
12	1970	630	3	x1	2/2
13	615	325	16	x4	1/2

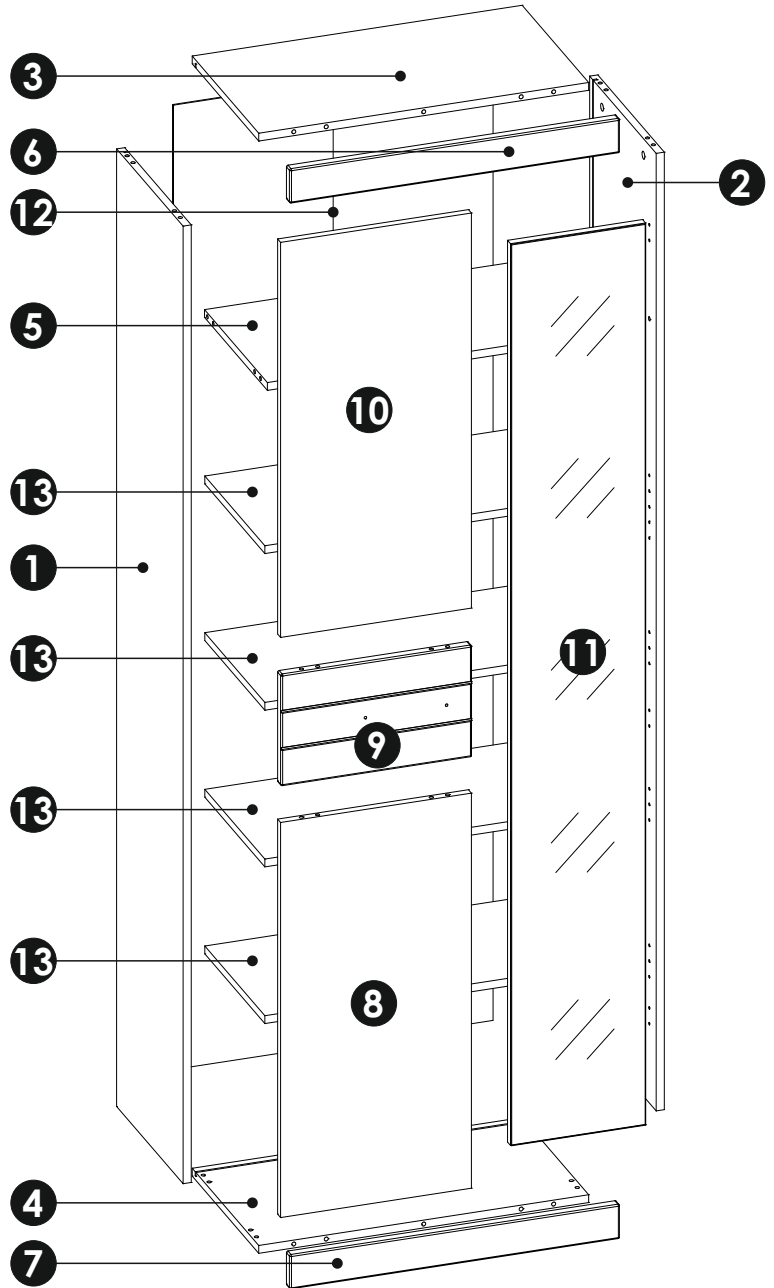

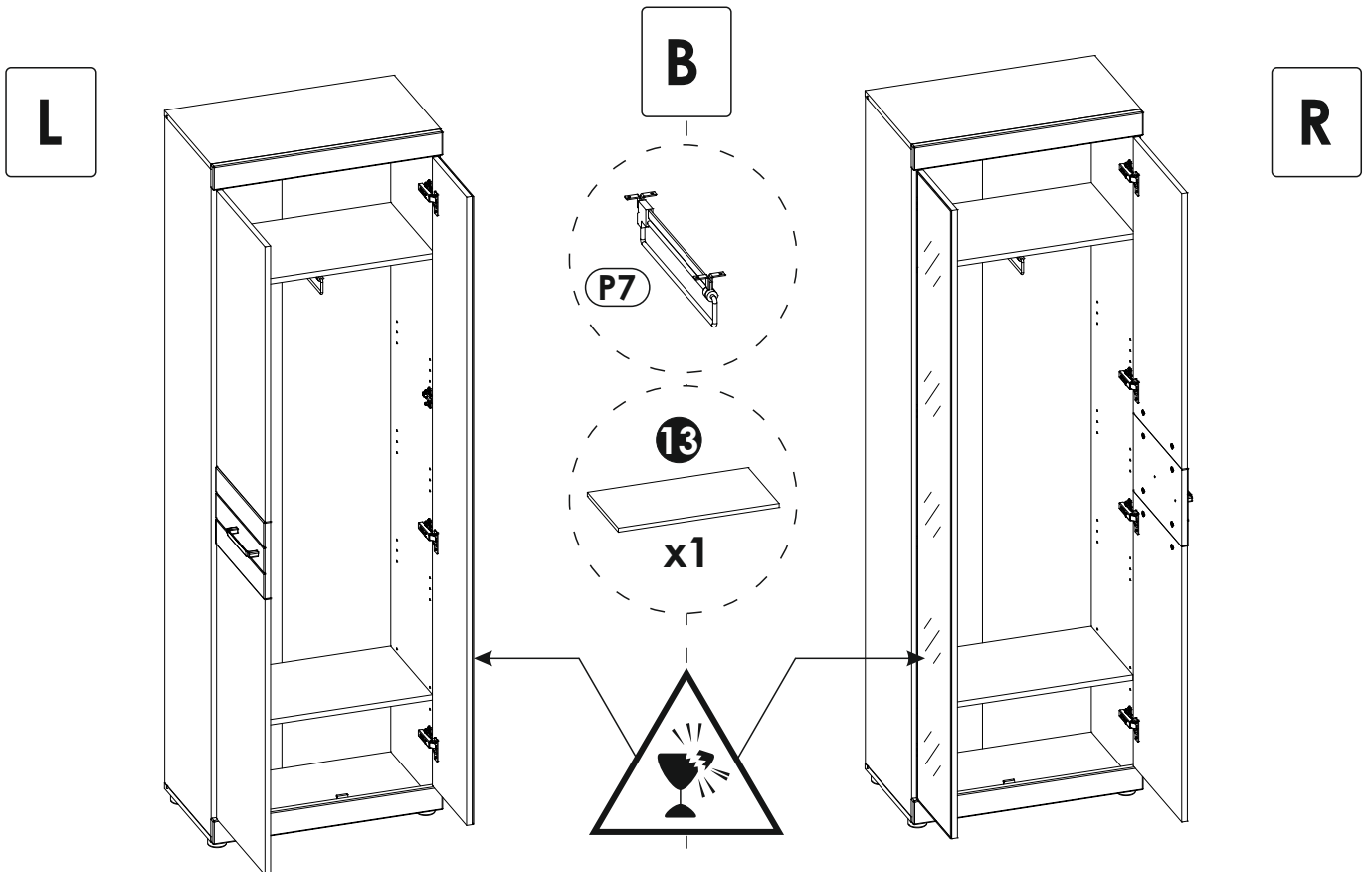
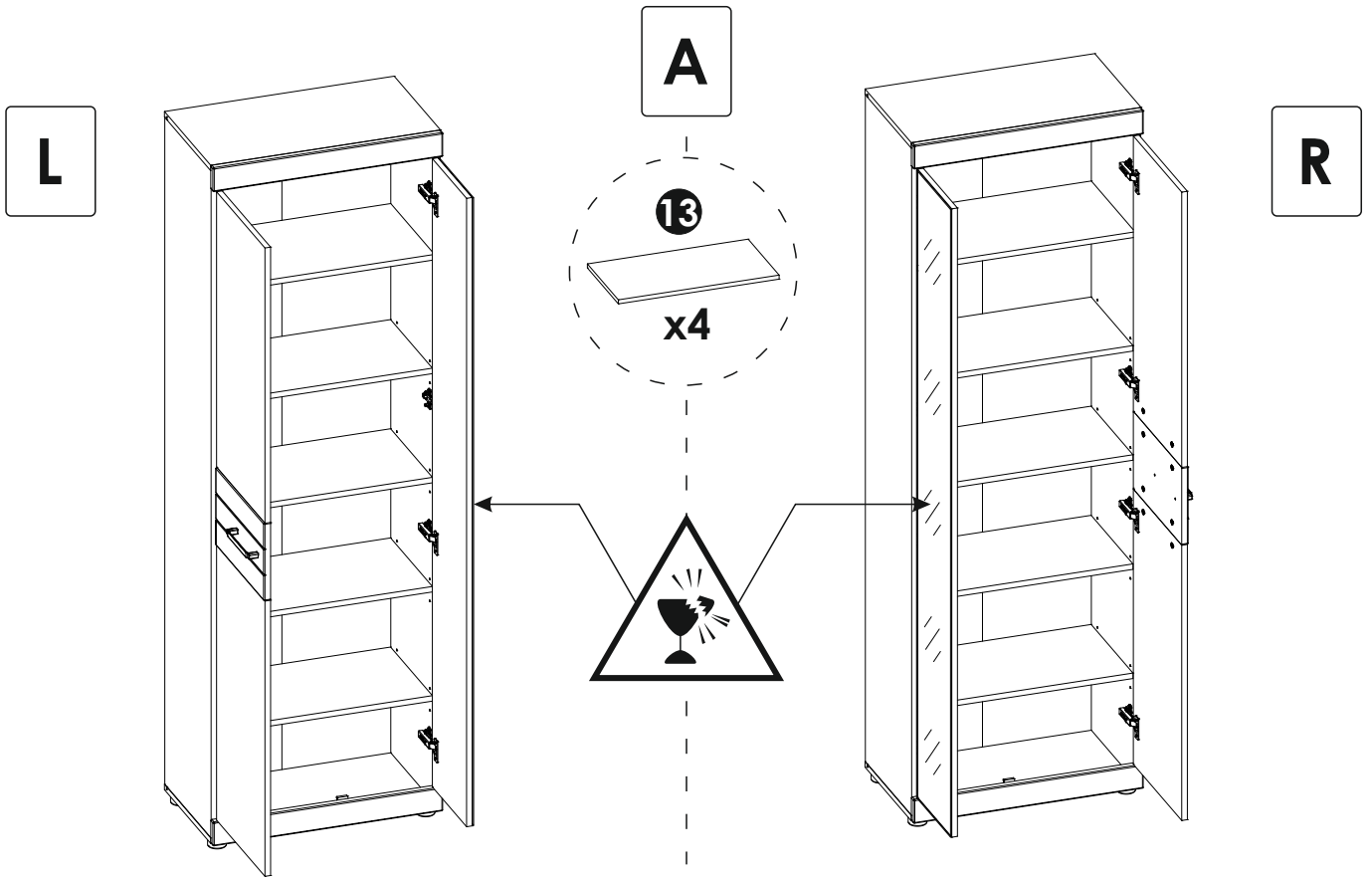

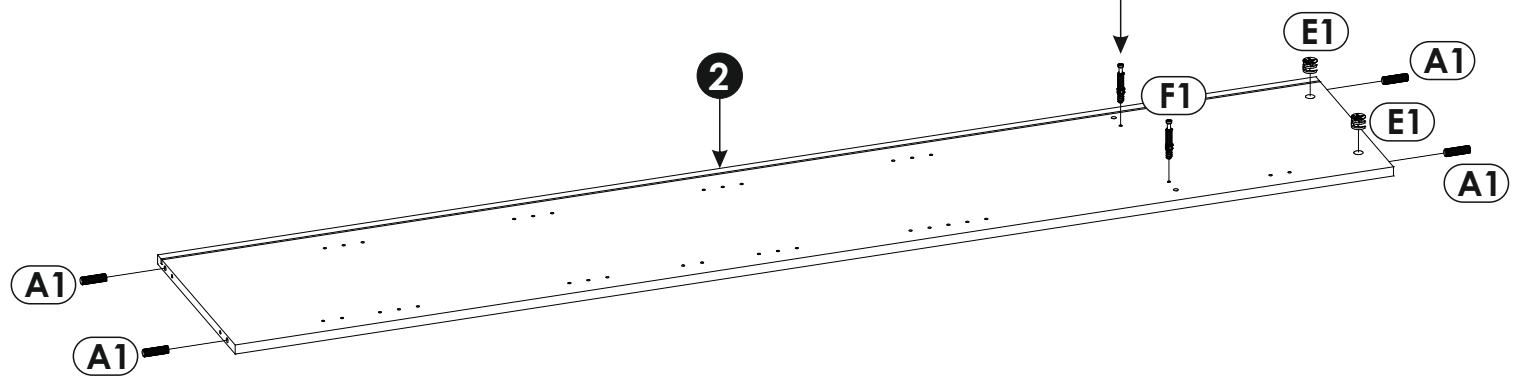
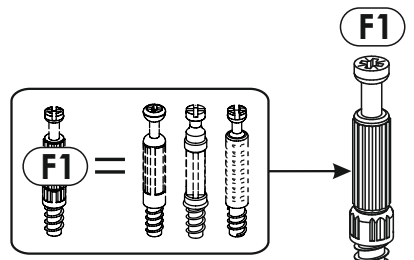
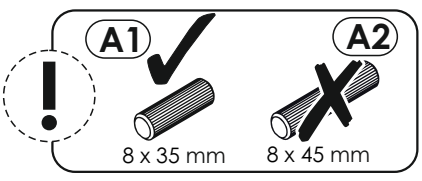
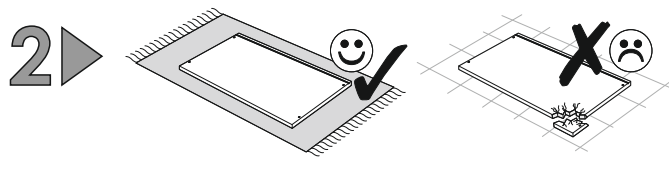
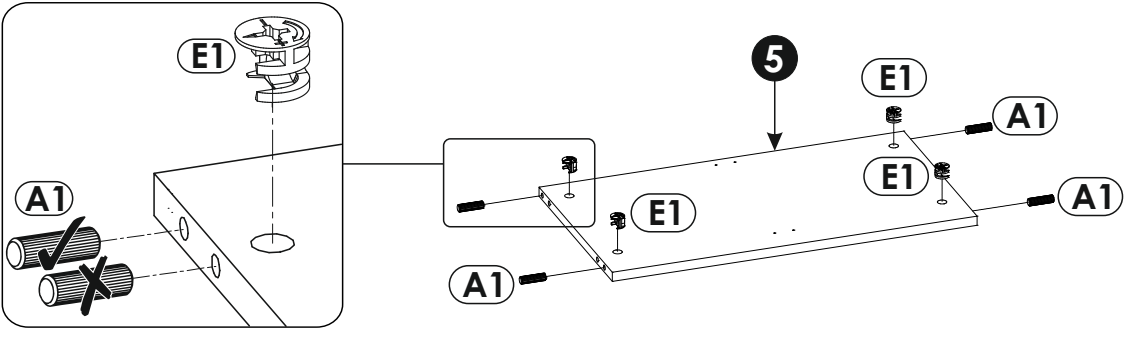
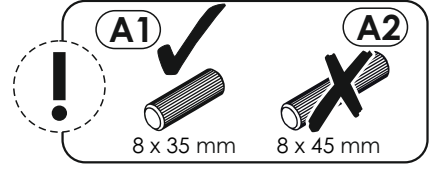
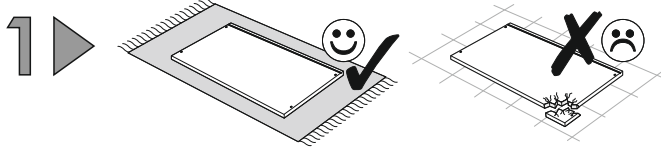

3 ▶

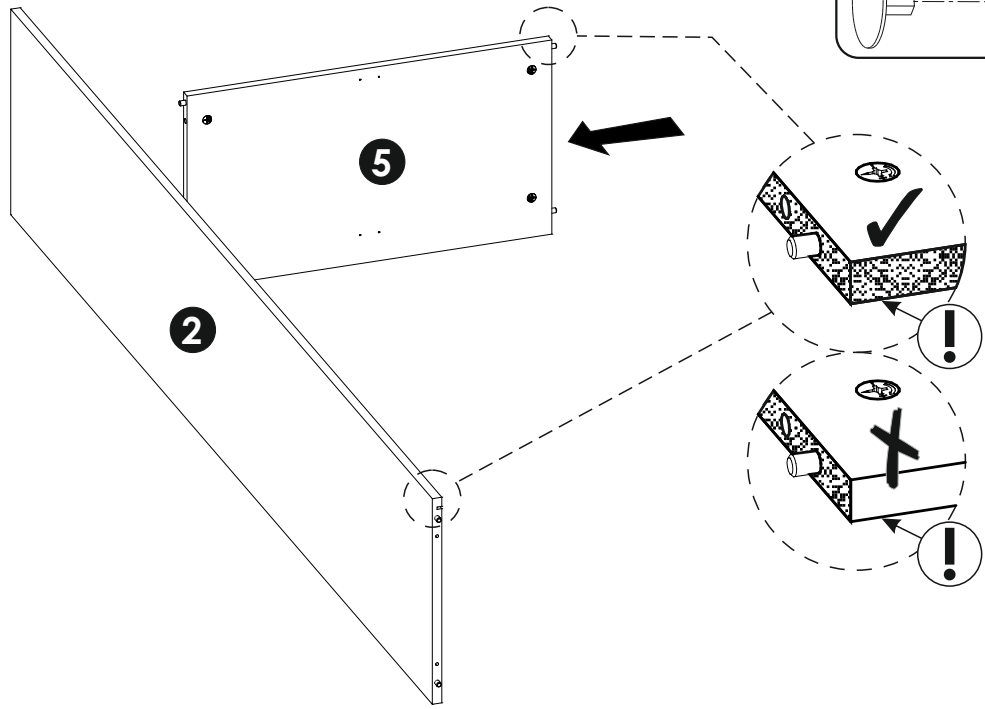
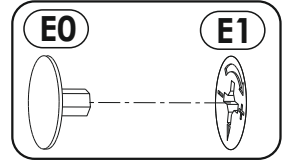
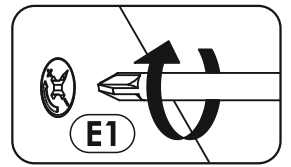
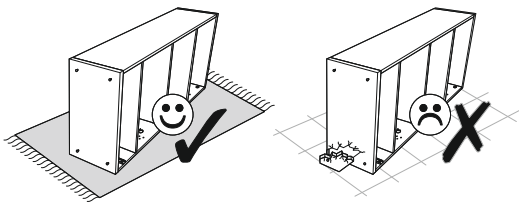

4 ▶

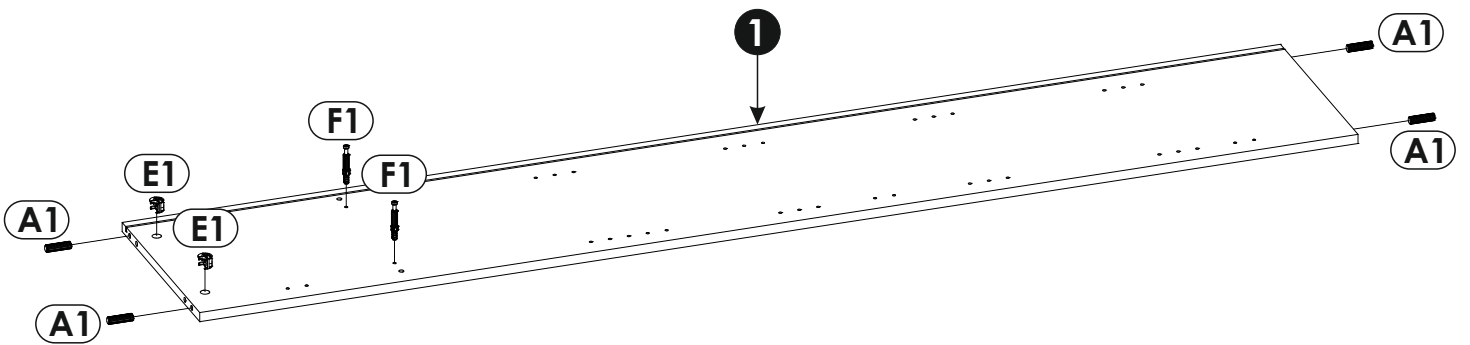
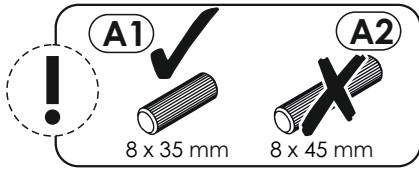
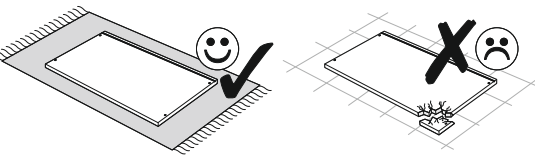

5 ▶

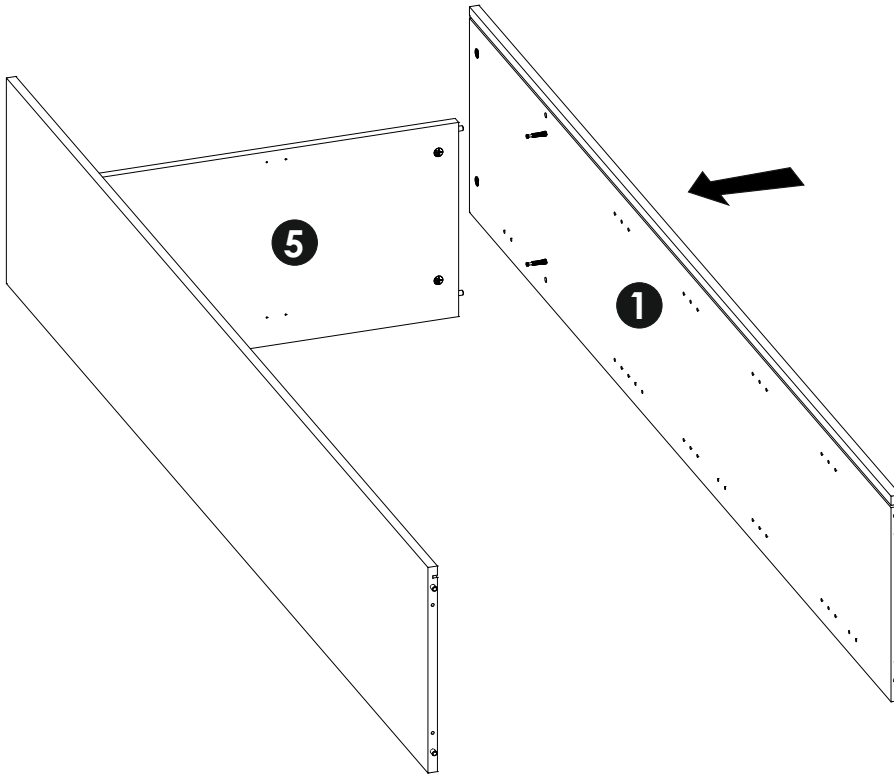
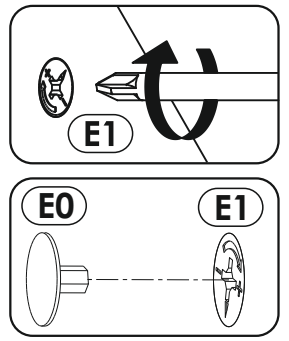
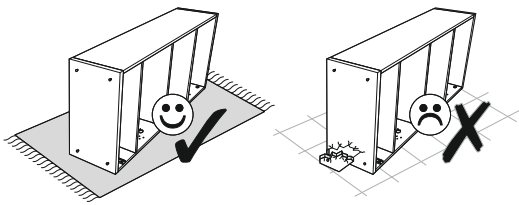

6 ▶

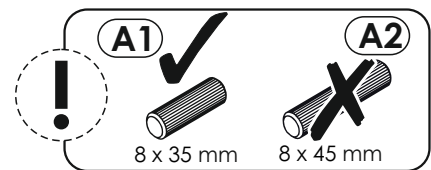
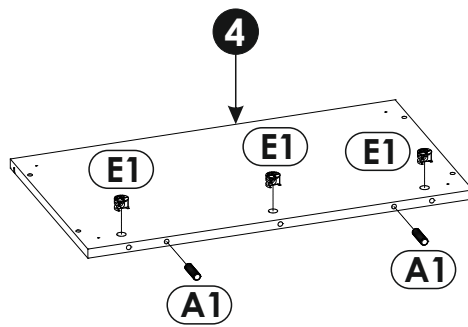
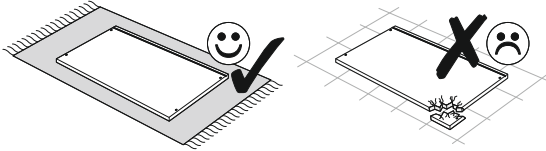

7 ▶

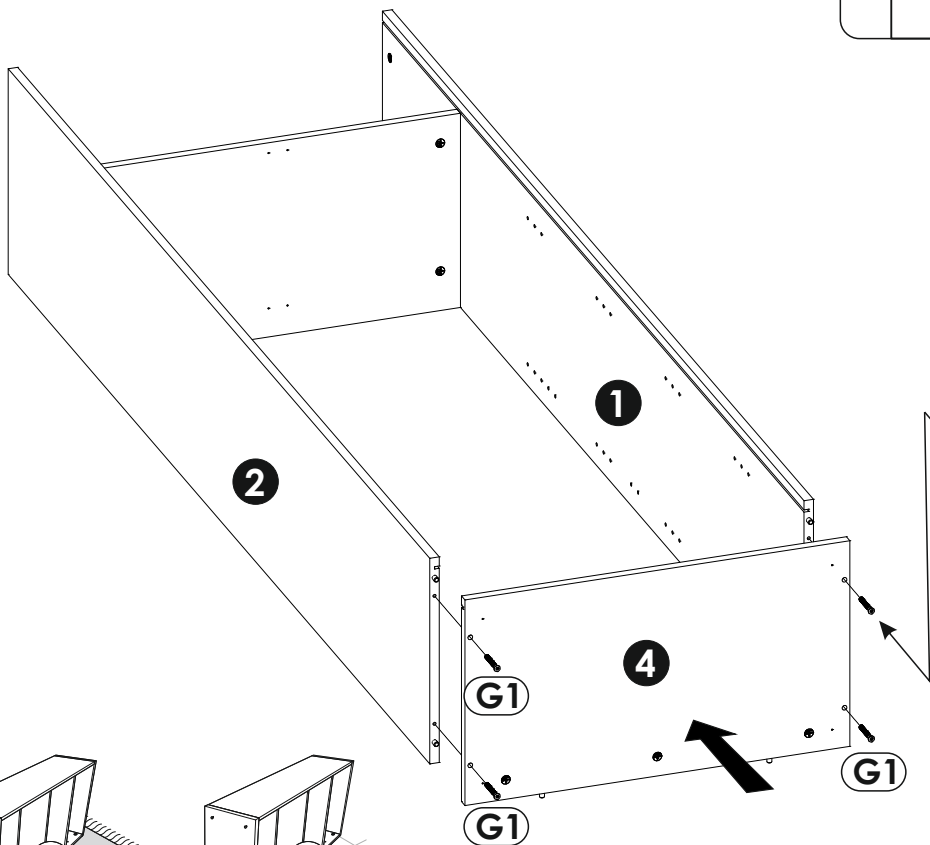
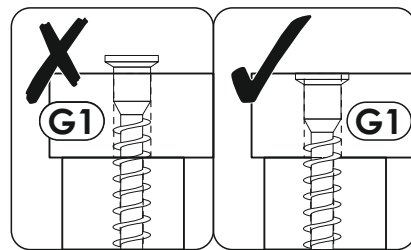
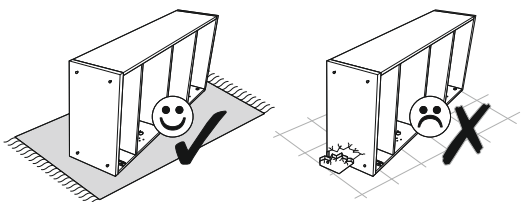

8 ▶

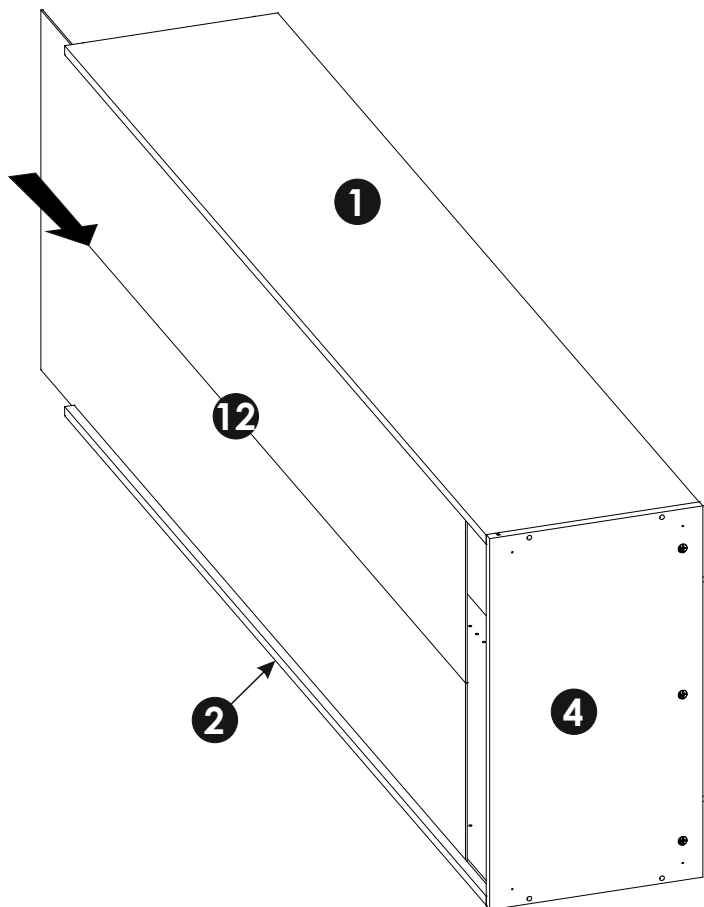
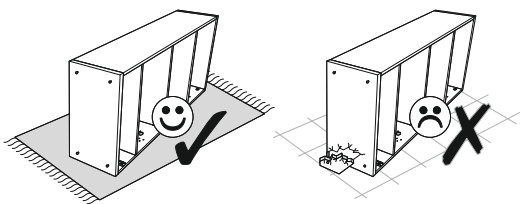

9 ▶

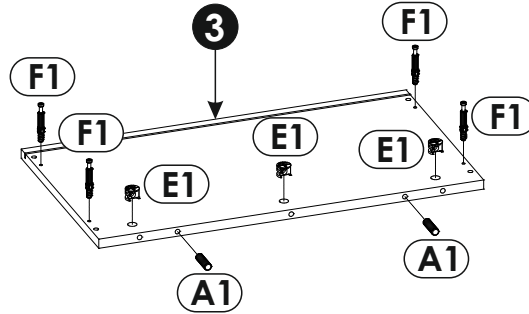
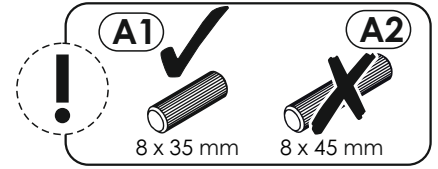
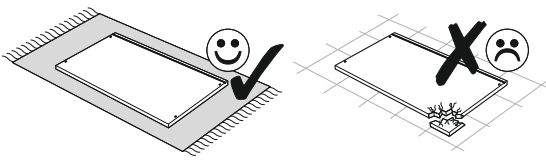

10 ▶

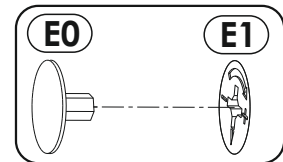
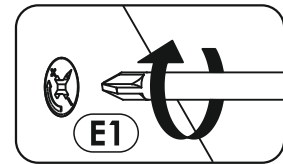
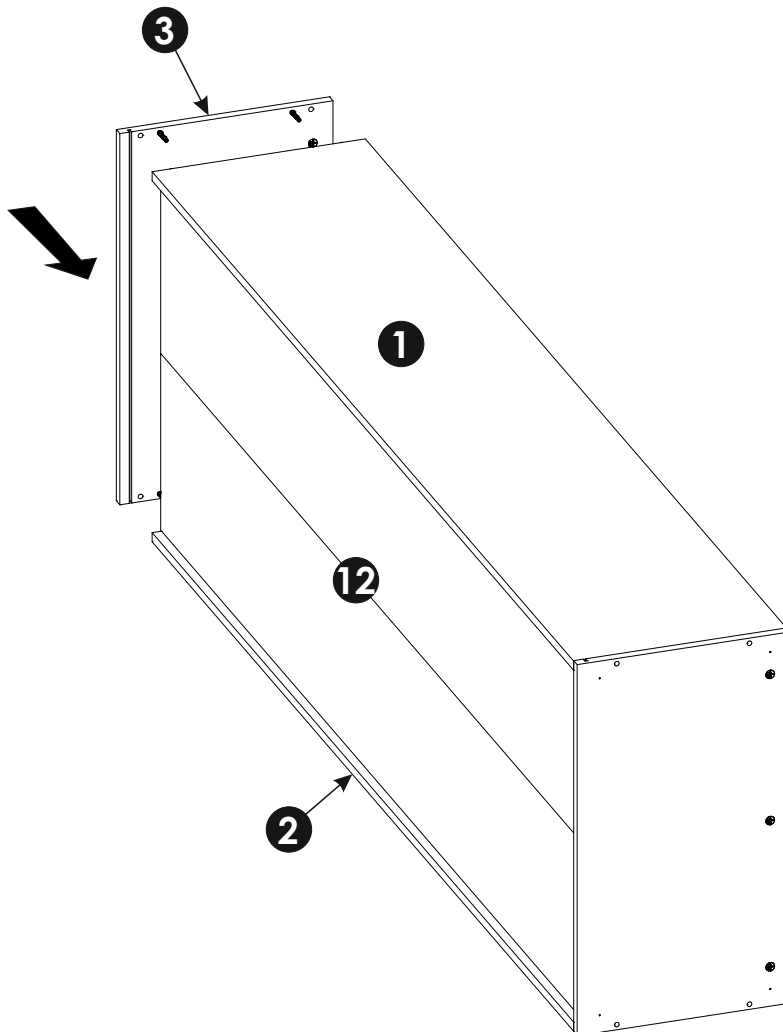
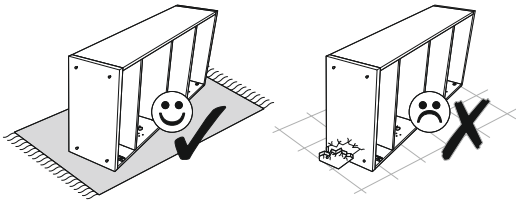

11 ▶

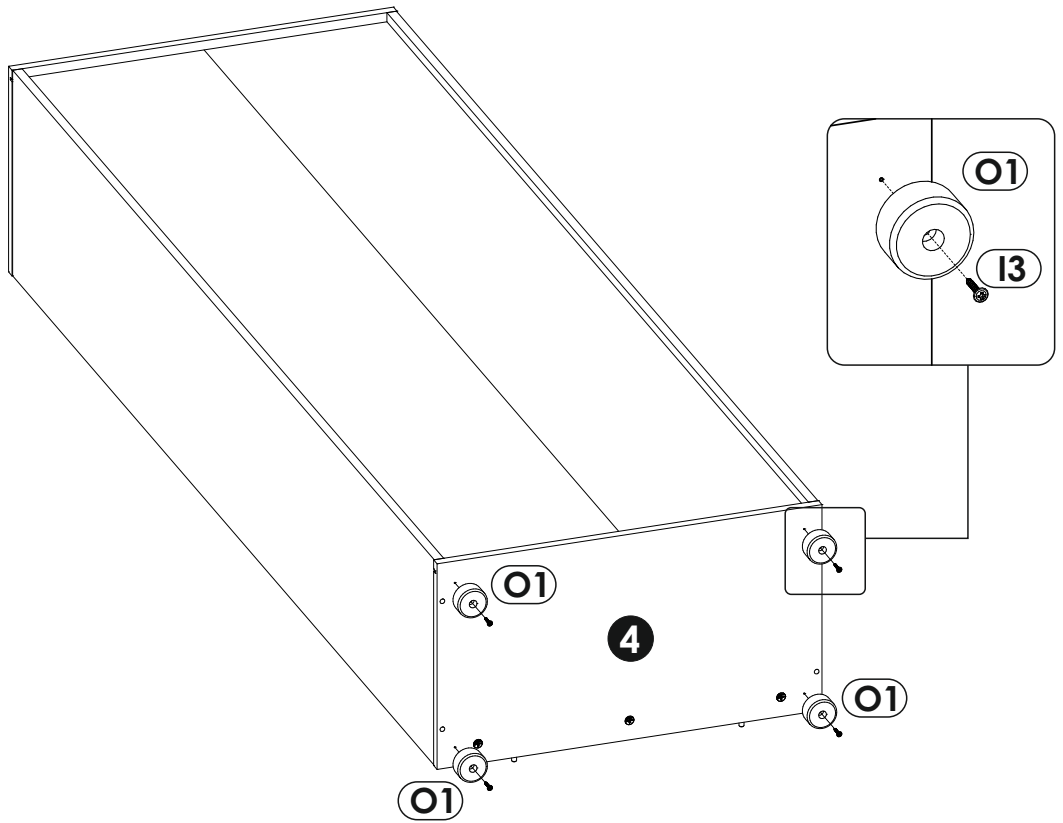
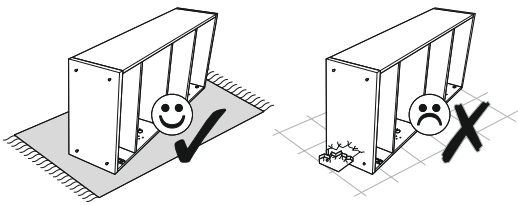

12 ▶

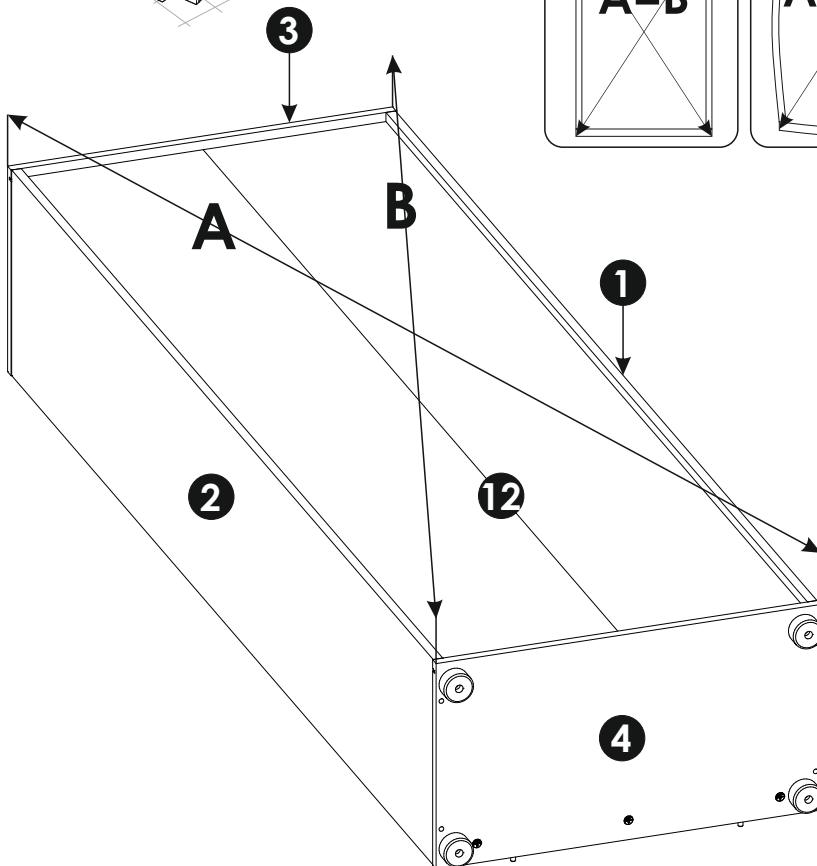
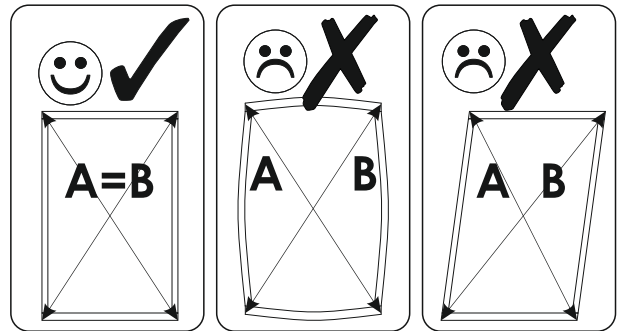
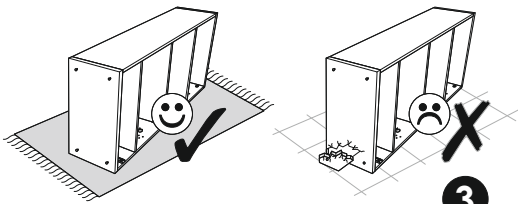

13 ▶

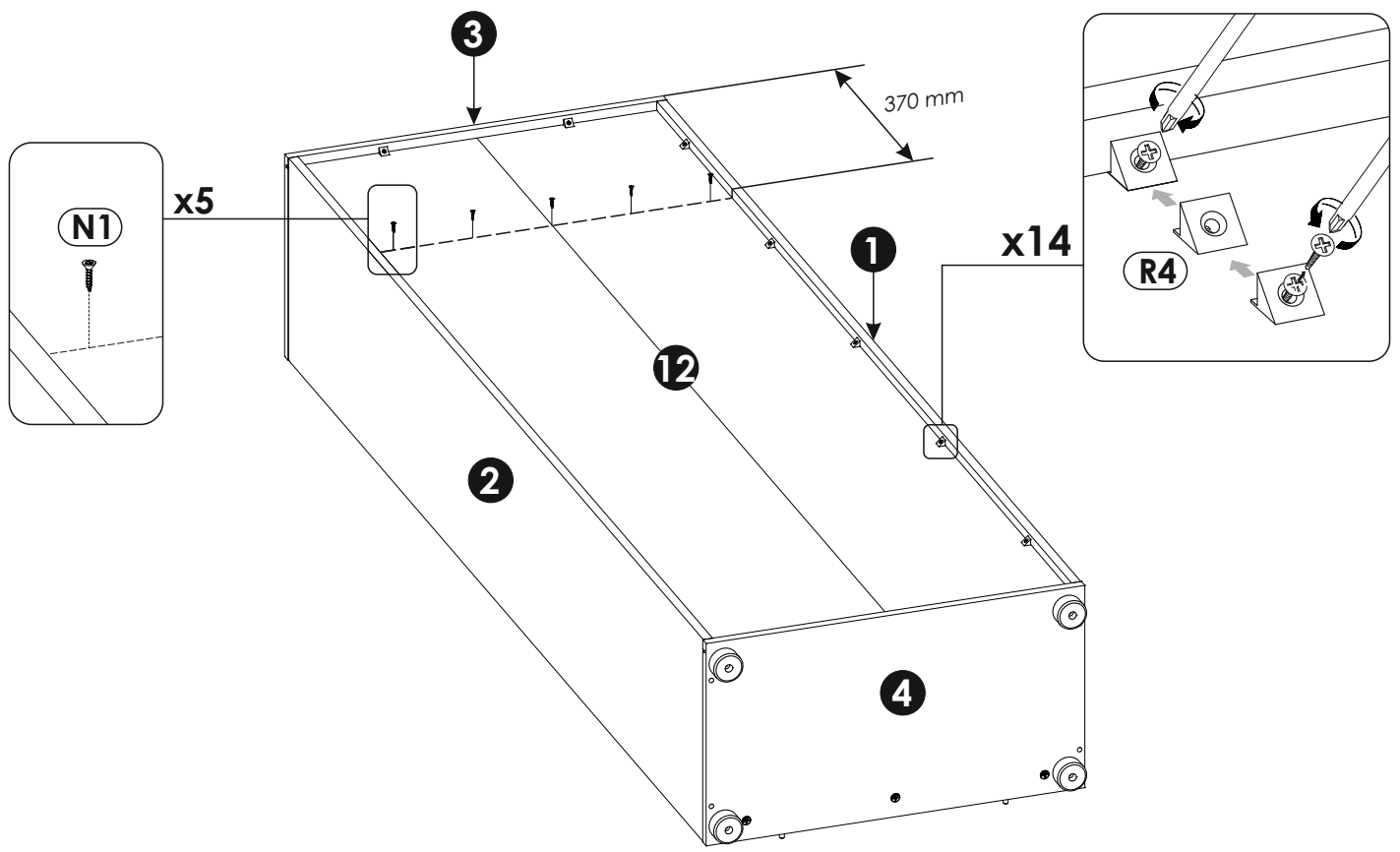
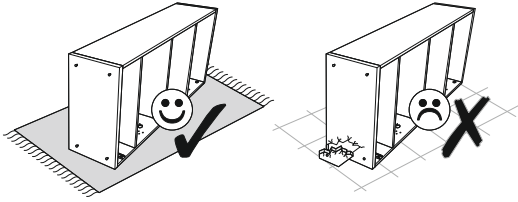

14▶

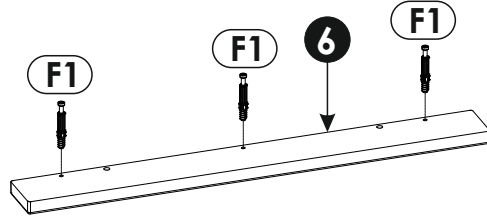
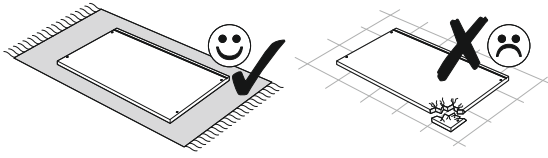

15▶

L

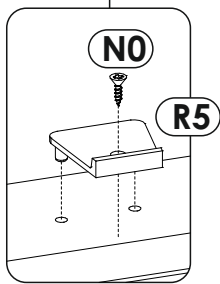
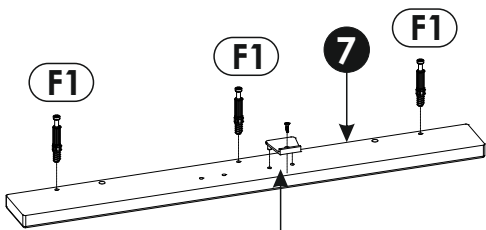
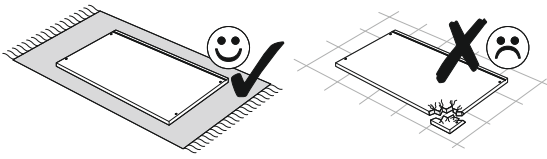

R

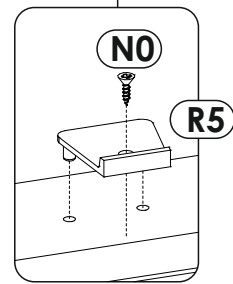
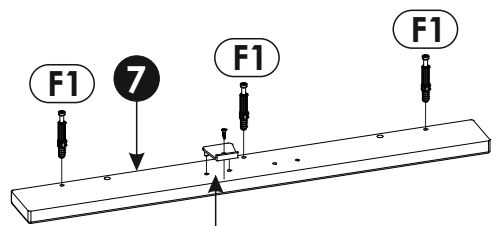
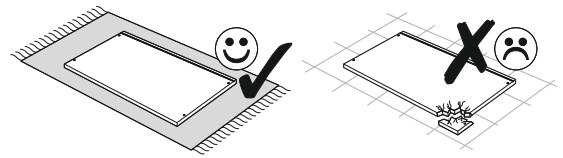

16 ▶

L

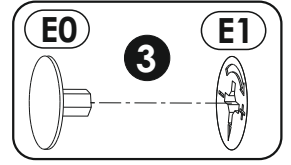
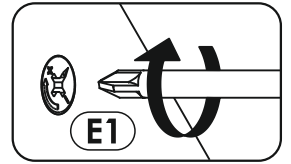
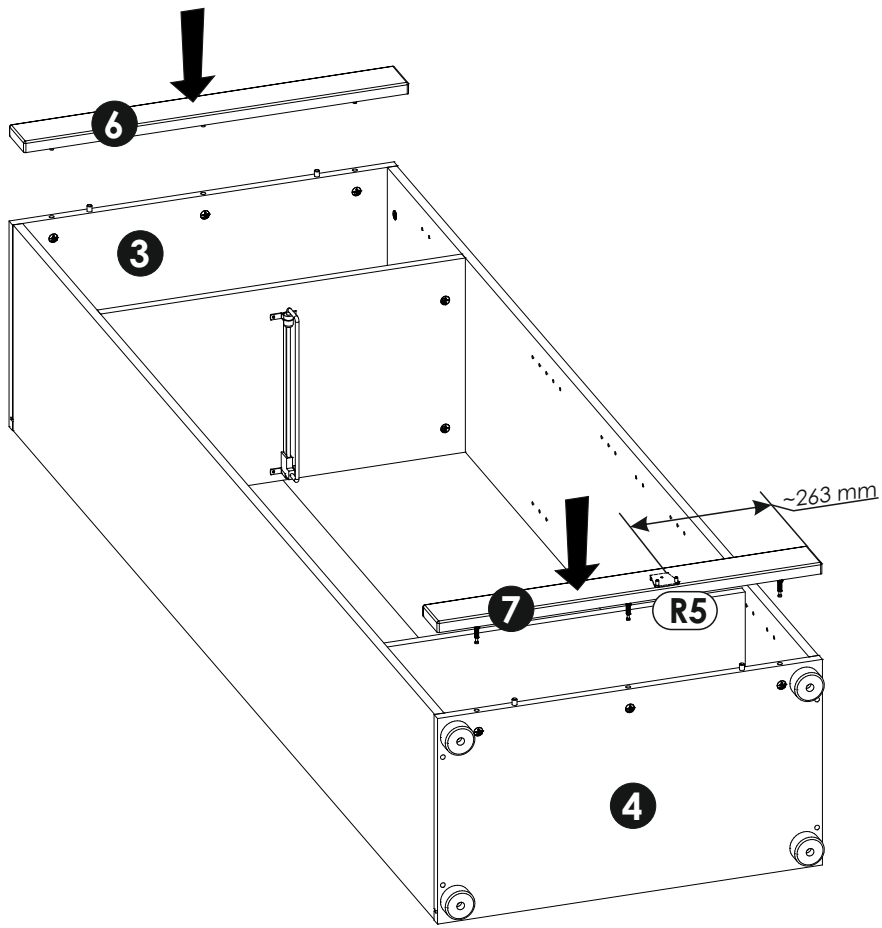

R

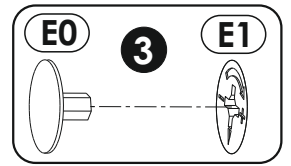
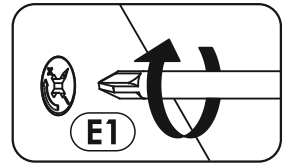
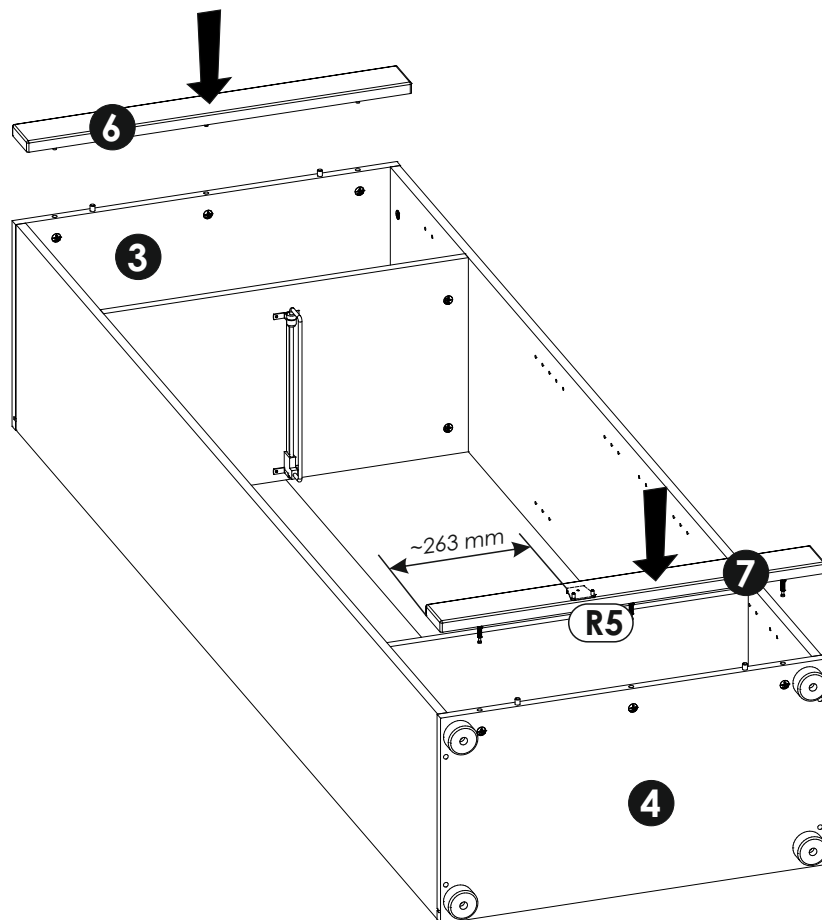

17 ▶

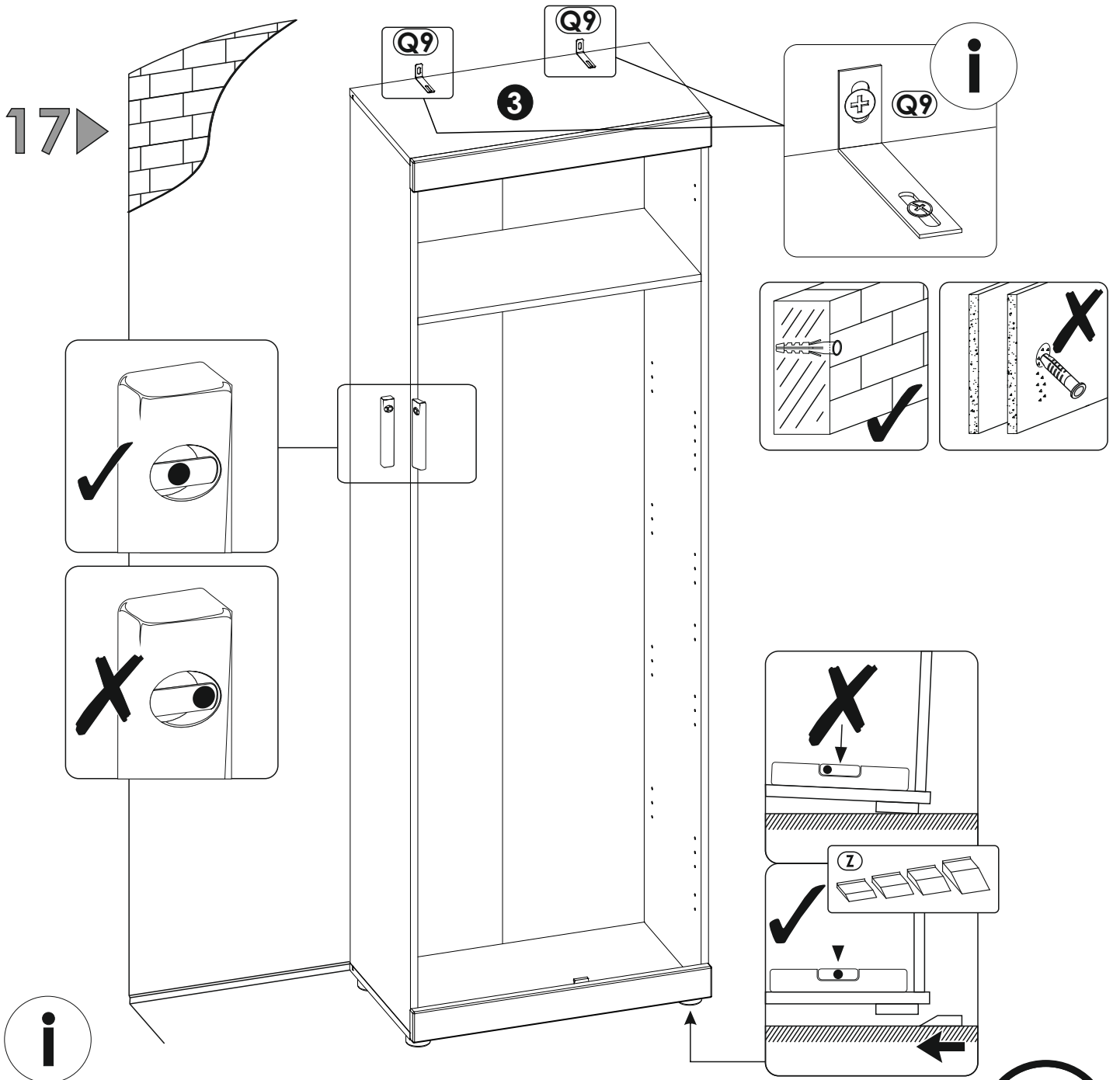

i

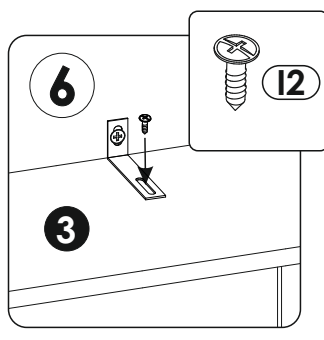
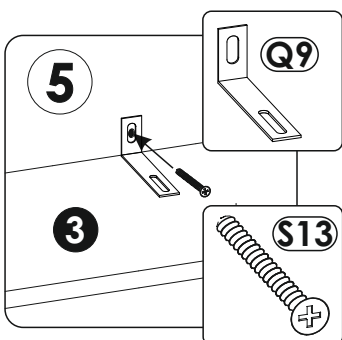
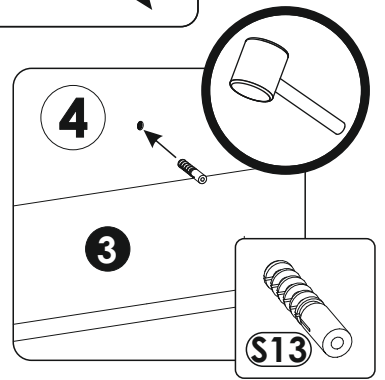
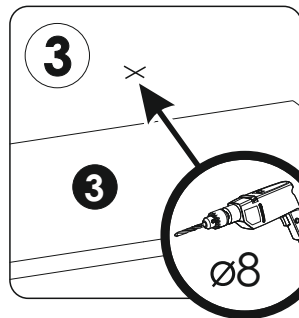
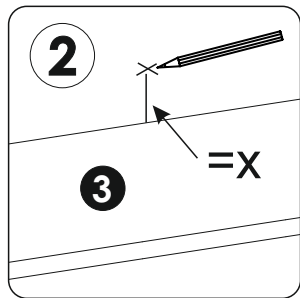
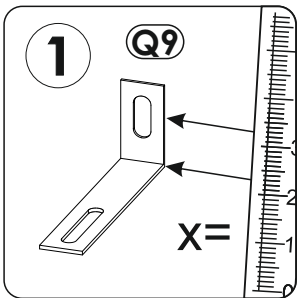

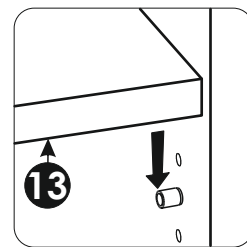
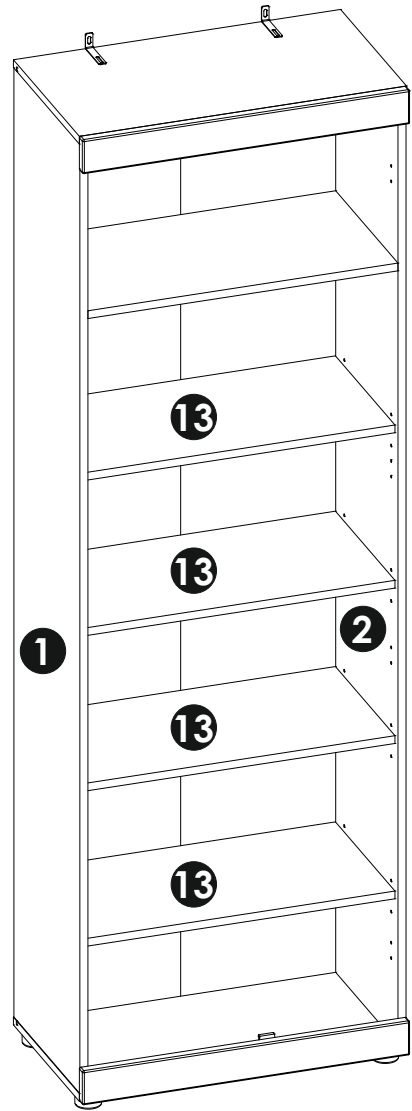
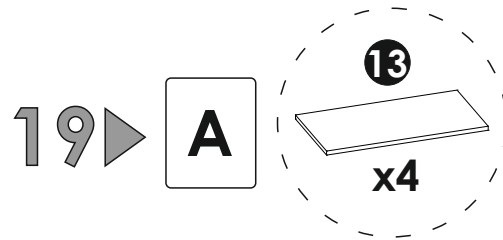
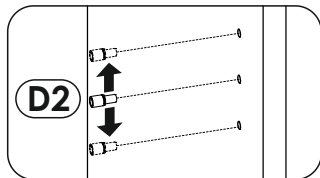
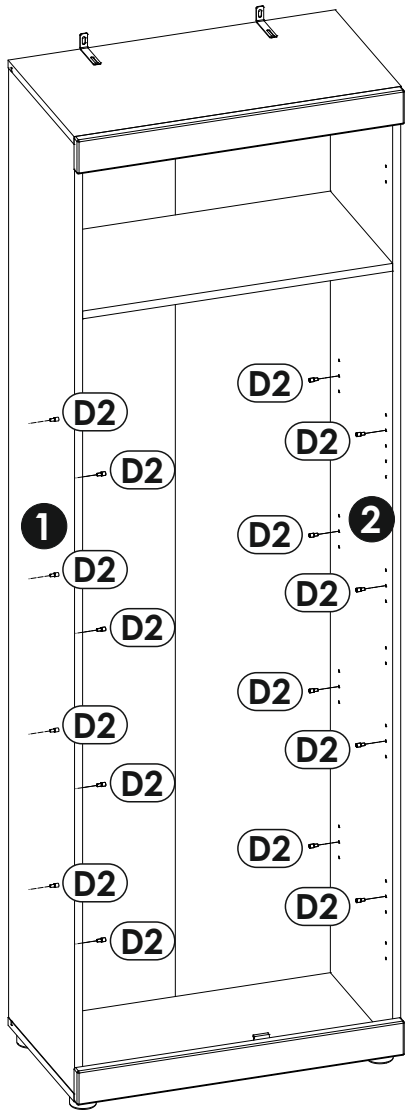
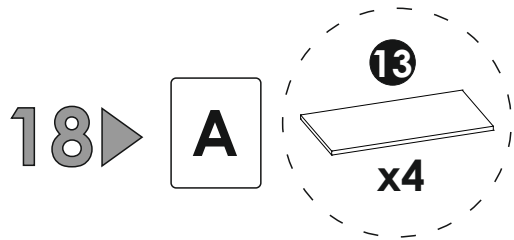

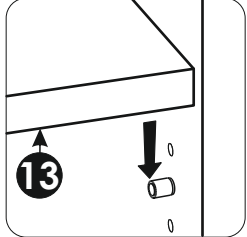
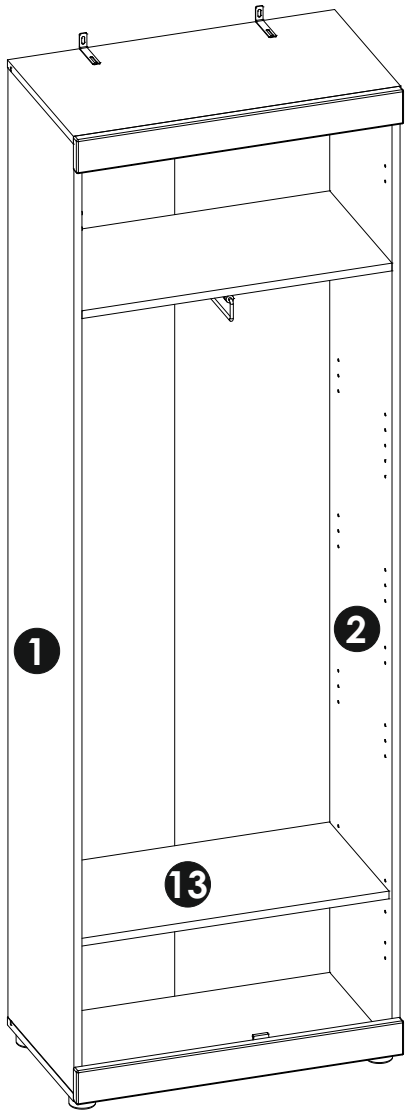
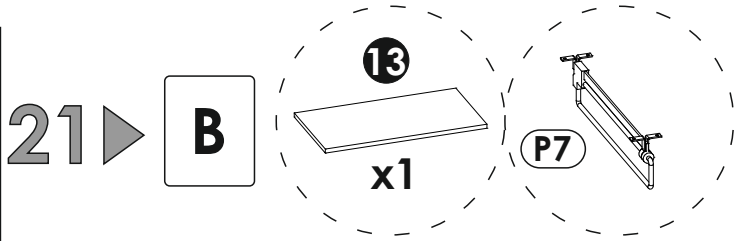
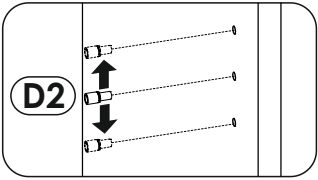
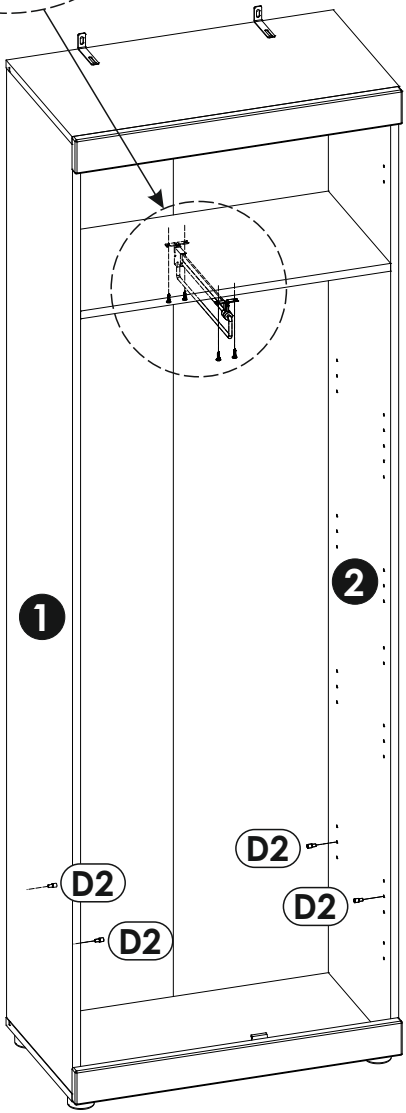
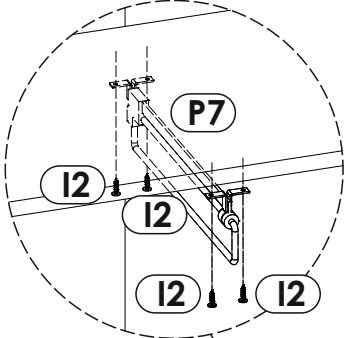
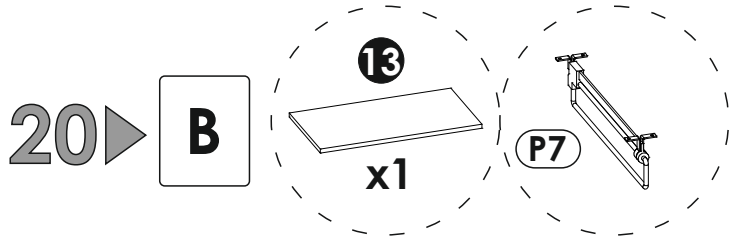

22 ▶

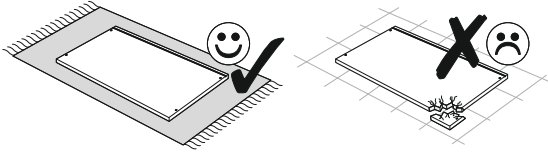

10

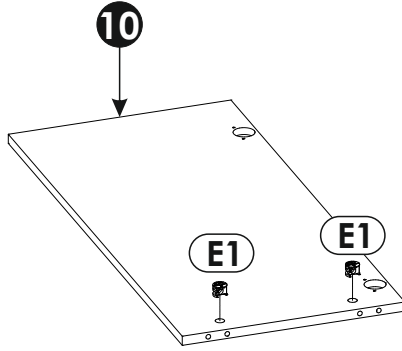

23 ▶

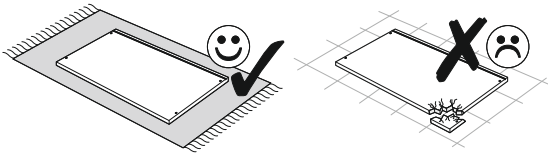

8

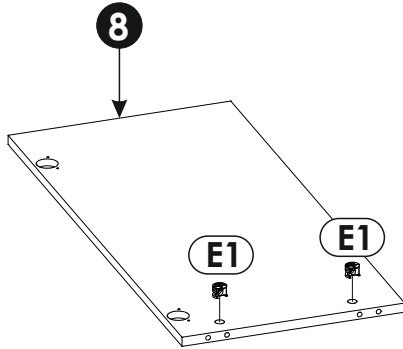

24▶

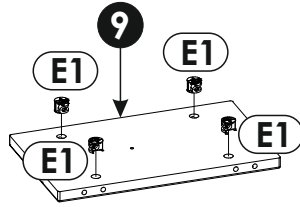
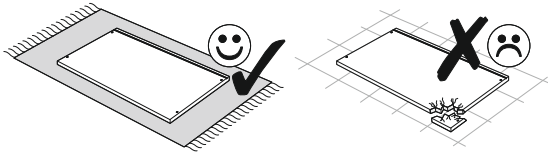

25▶

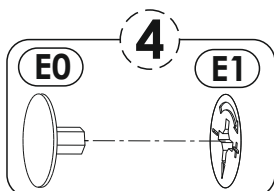
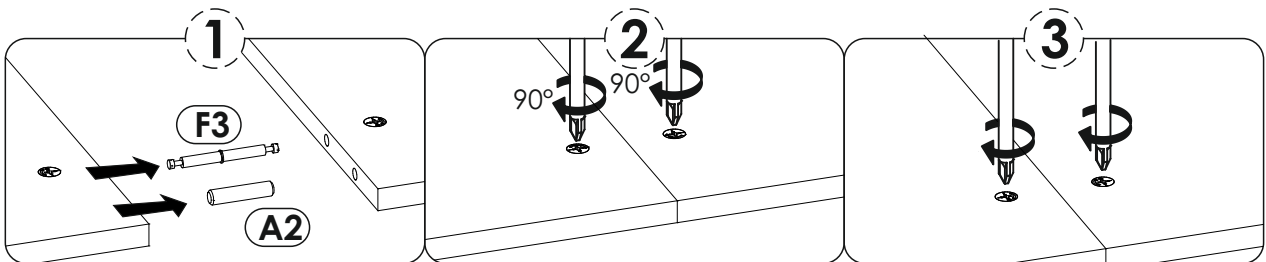
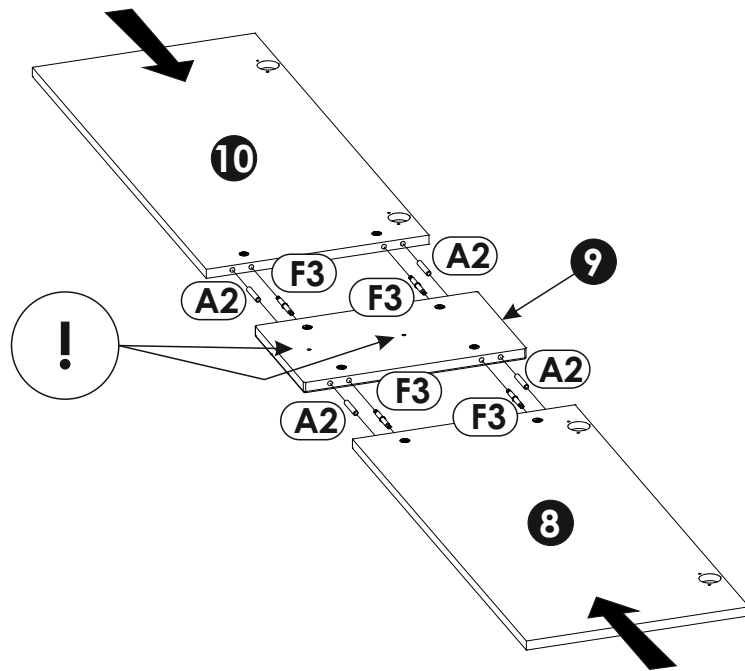
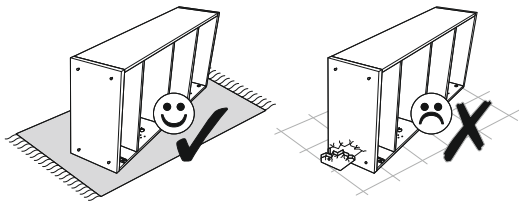

26 ▶

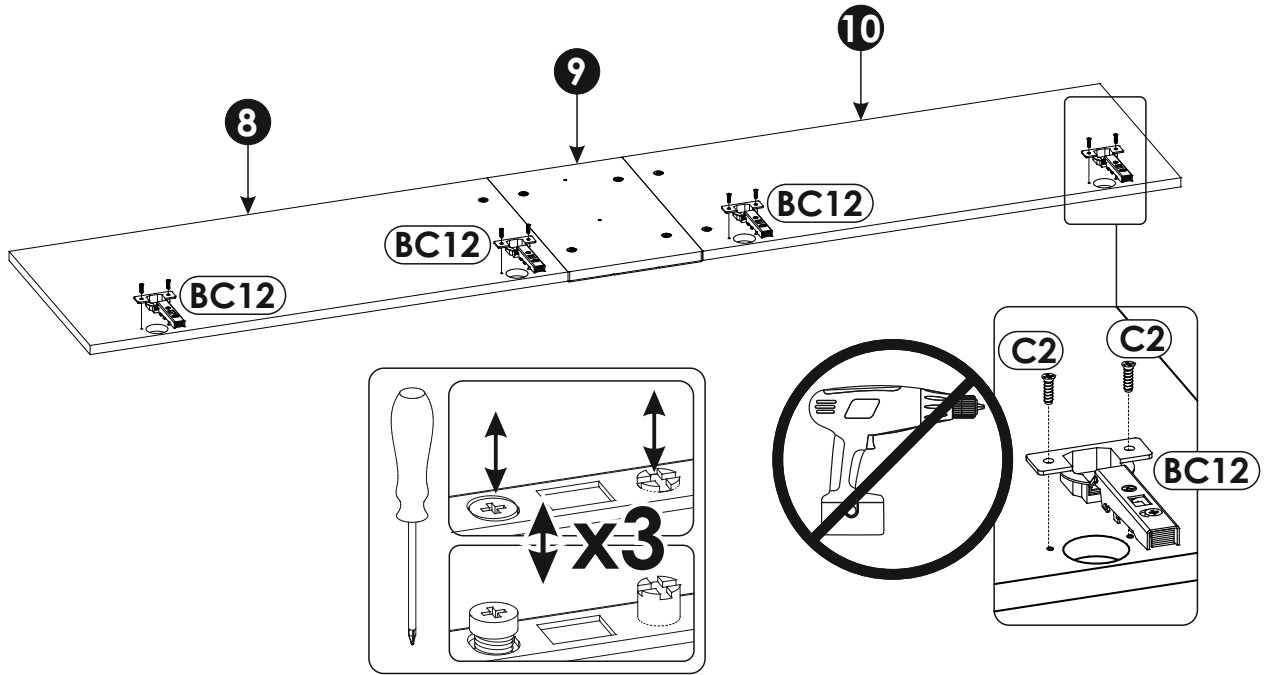
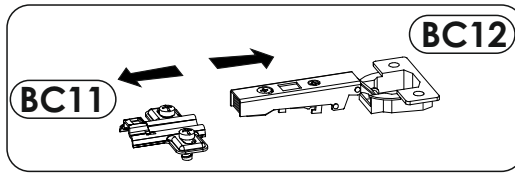
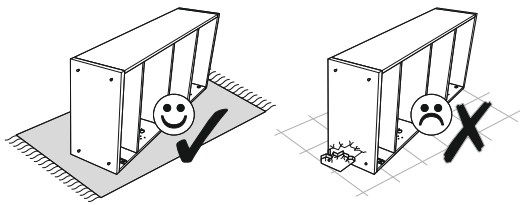

27 ▶

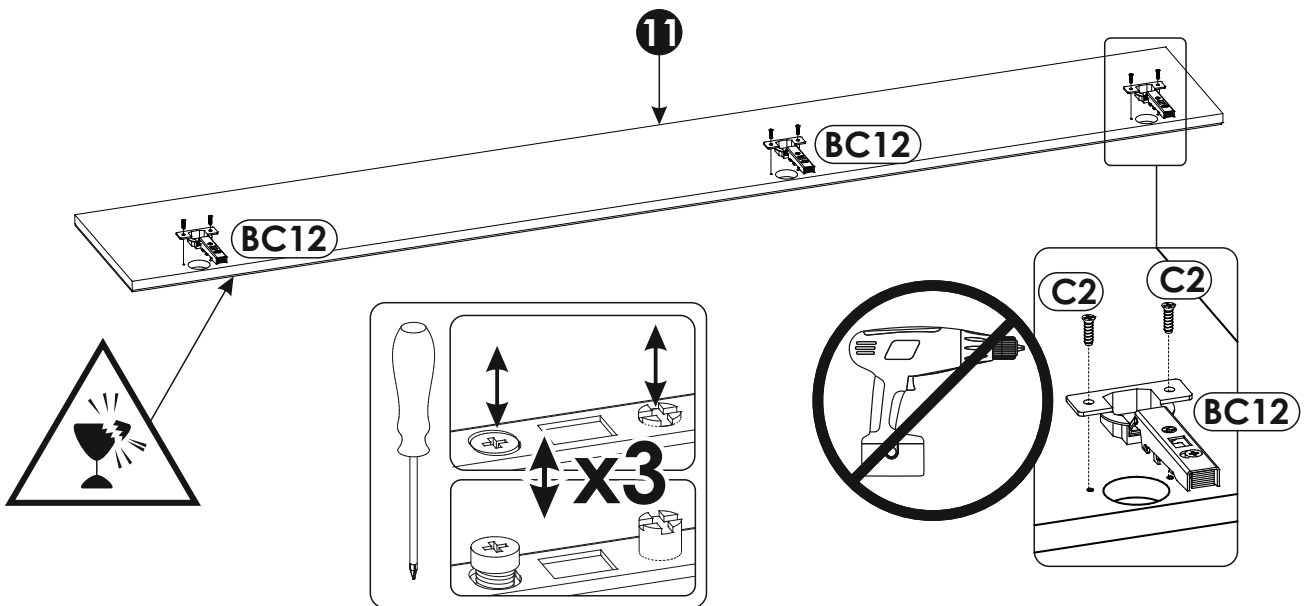
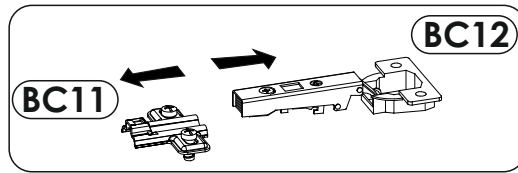
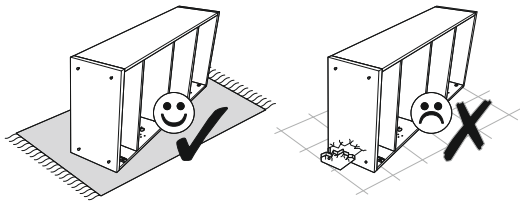

L

R

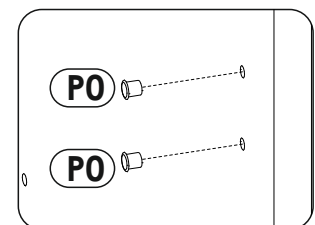
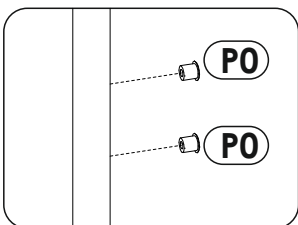
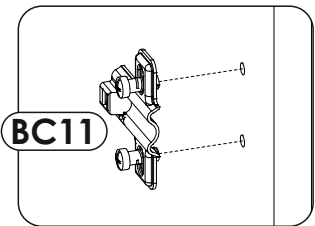
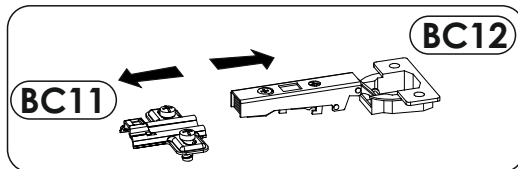
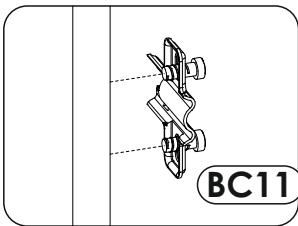
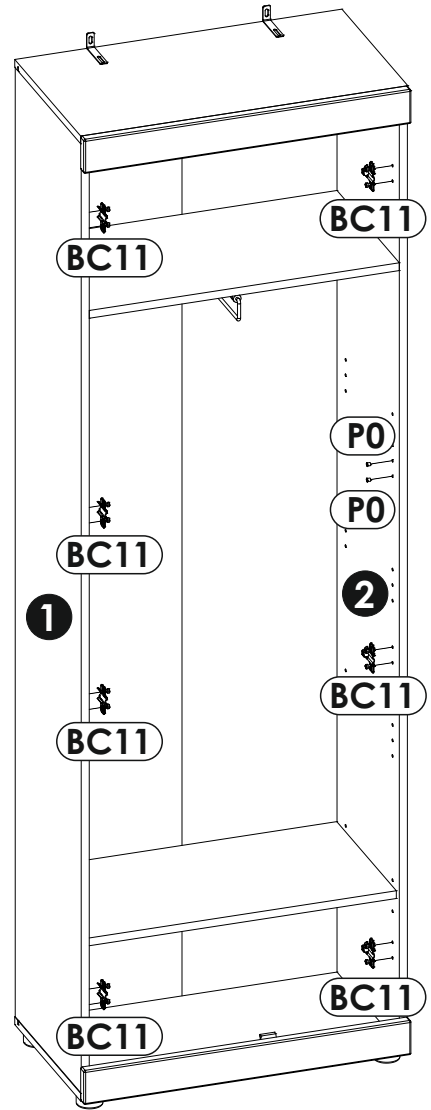
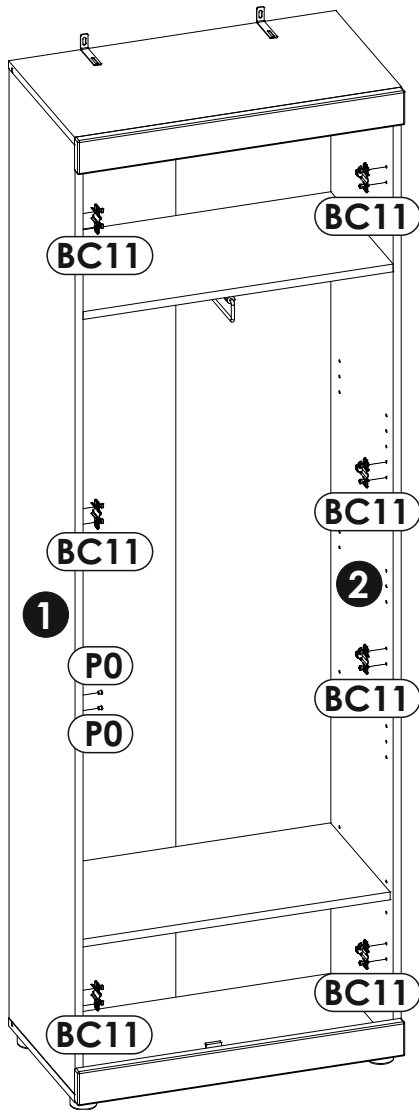

L

R

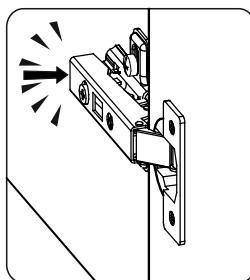
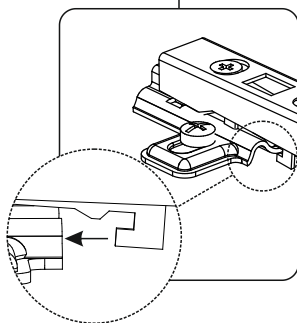
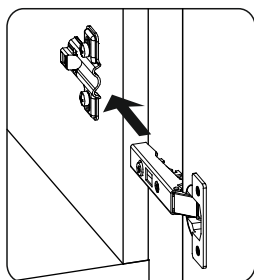
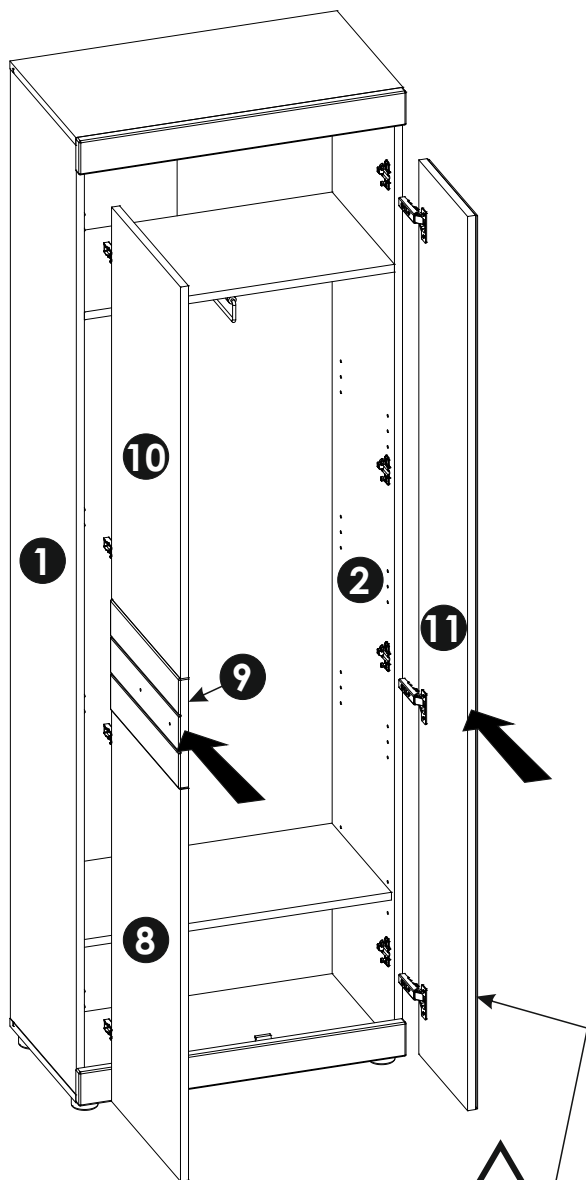
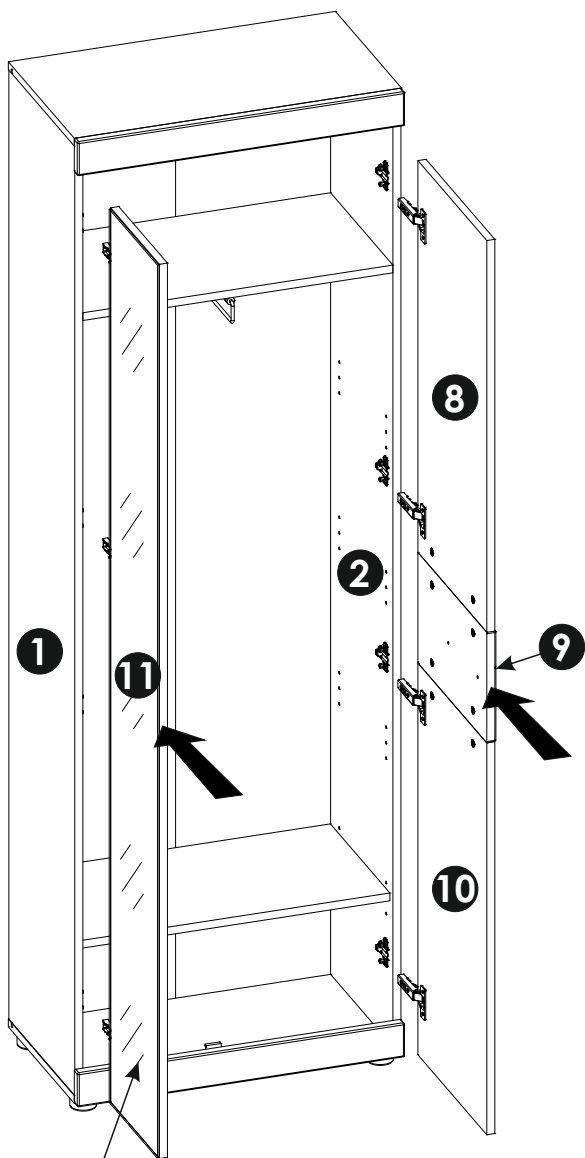

L

R

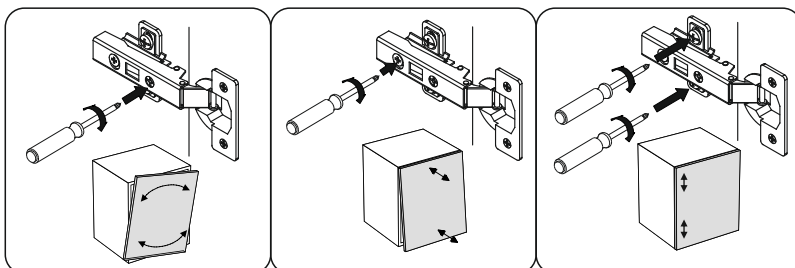
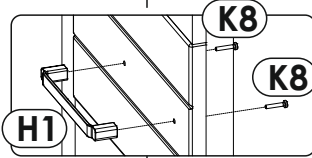
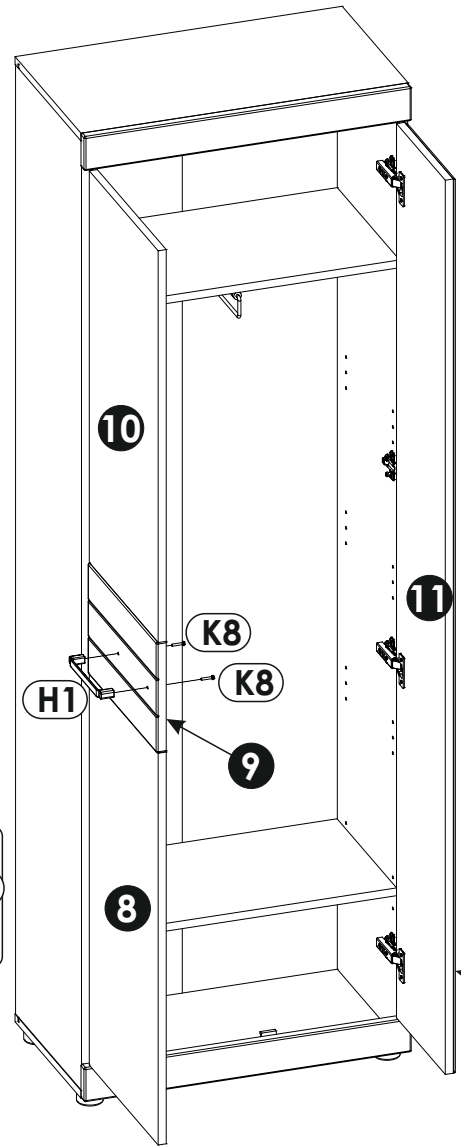
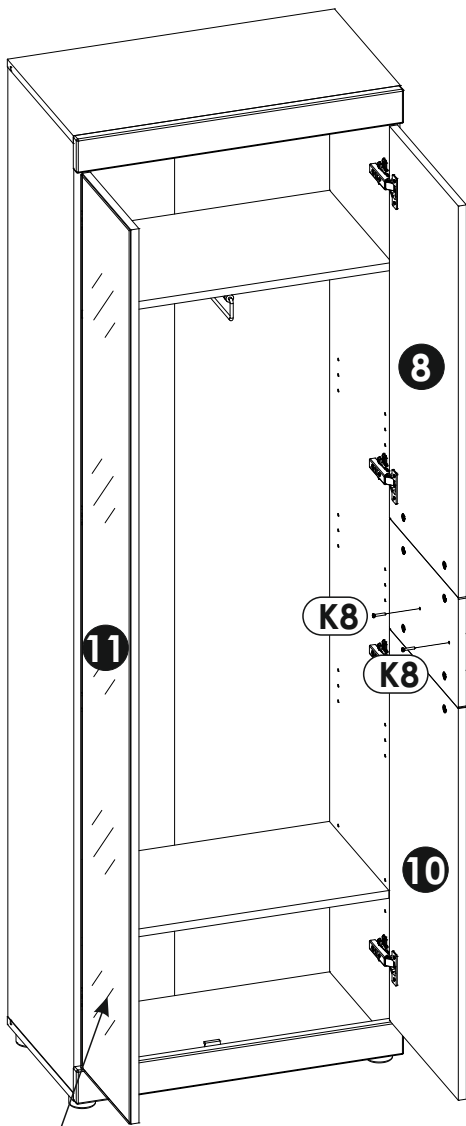

31 ▶

