

2019-06-26

2,5 h

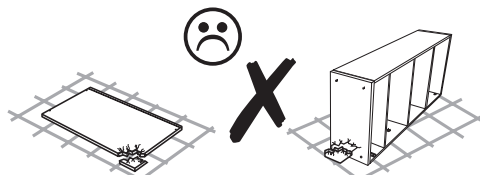

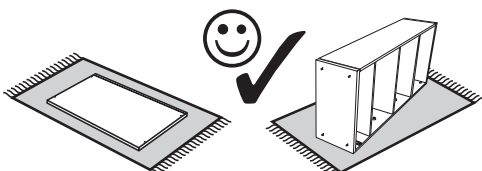
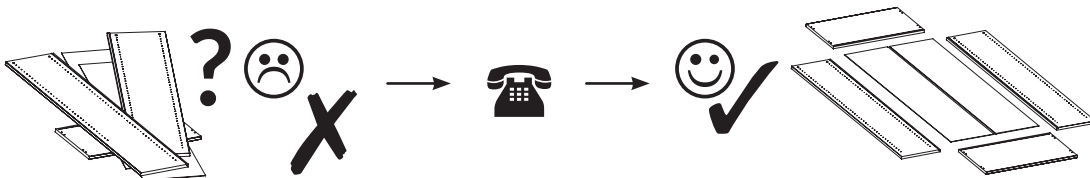
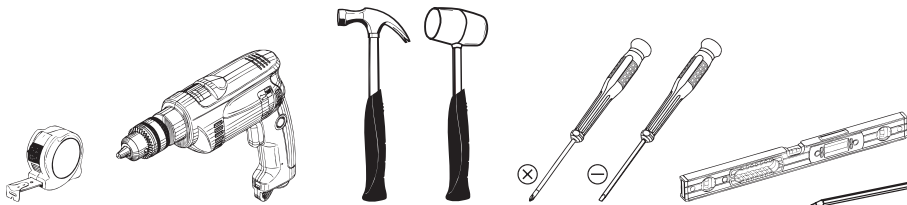
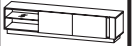

<p>A</p> <p>7 x 50 mm x 8</p>	<p>B</p> <p>8 x 32 mm x 32</p>	<p>C</p> <p>(CD) x 4</p>	<p>DT</p> <p>x 4</p>	<p>E</p> <p>3,5 x 13 mm x 24</p>	<p>E2</p> <p>3 x 20 mm x 4</p>
<p>G2</p> <p>x 6</p>	<p>H1</p> <p>x 10</p>	<p>O2</p> <p>x 2</p>	<p>P2</p> <p>x 4</p>	<p>R</p> <p>H=11 mm x 10</p>	<p>U</p> <p>L=24,3 mm x 10</p>
<p>Y1</p> <p>x 2</p>	<p>XA</p> <p>x 1</p>	<p>XG</p> <p>x 1</p>	<p>ZR</p> <p>Ø 15 x 10</p>		

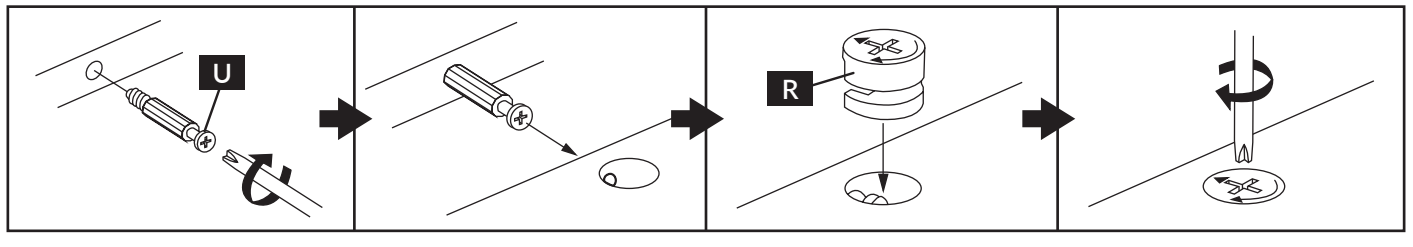
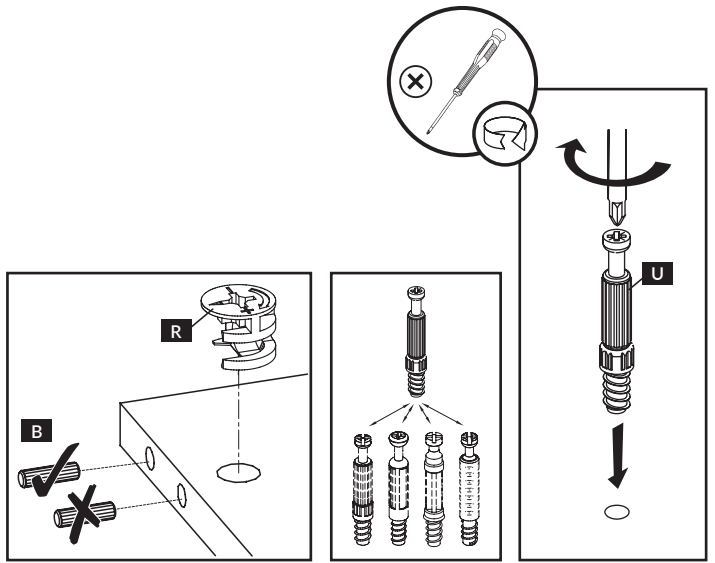
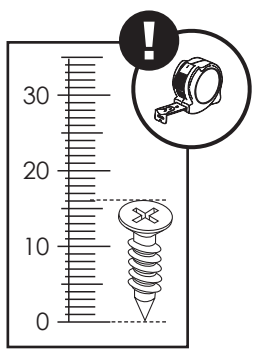
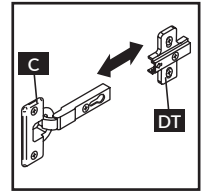

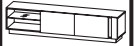

nr	↔ [mm]	↓ [mm]	∇ [mm]	Menge	Colli
H-1	1794	80	16	x 1	1/1
H-2	288	80	16	x 2	1/1
H-3	1874	384	16	x 1	1/1
H-4	1874	384	16	x 1	1/1
H-5	565	330	4	x 1	1/1
H-6	338	384	16	x 1	1/1
H-7	338	369	16	x 1	1/1
H-8	338	369	16	x 1	1/1
H-9	338	384	16	x 1	1/1
H-10	100	338	16	x 1	1/1
H-11	96	370	16	x 1	1/1
H-12	568	370	16	x 2	1/1
H-13	1852	352	3	x 1	1/1

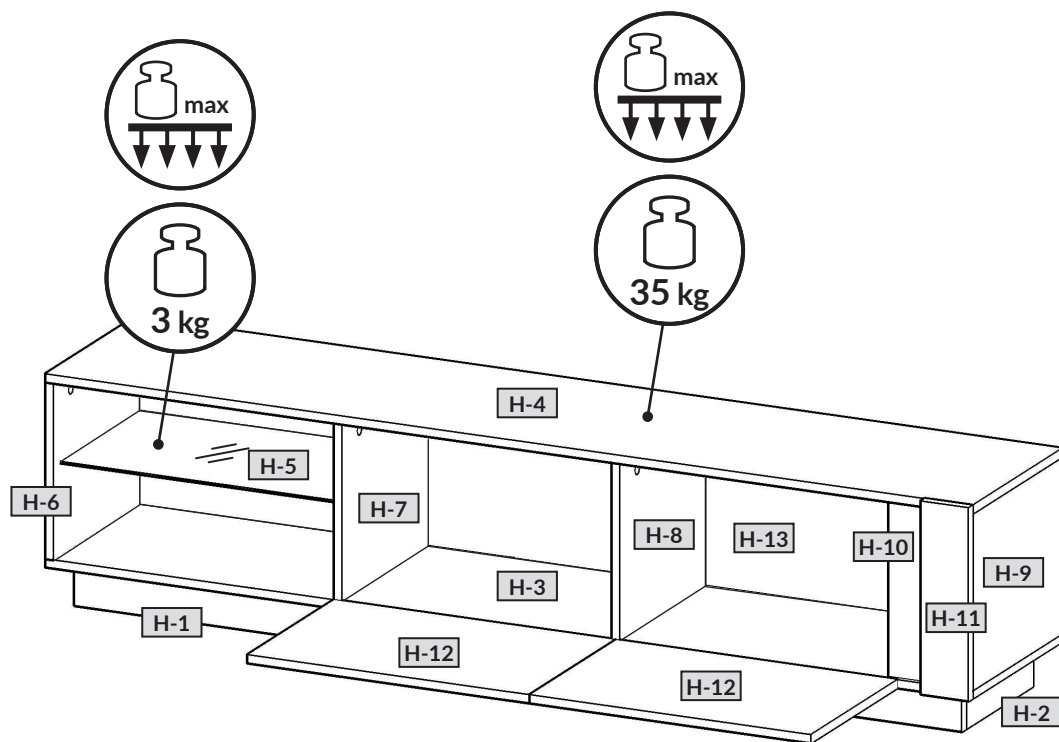

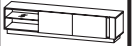

1

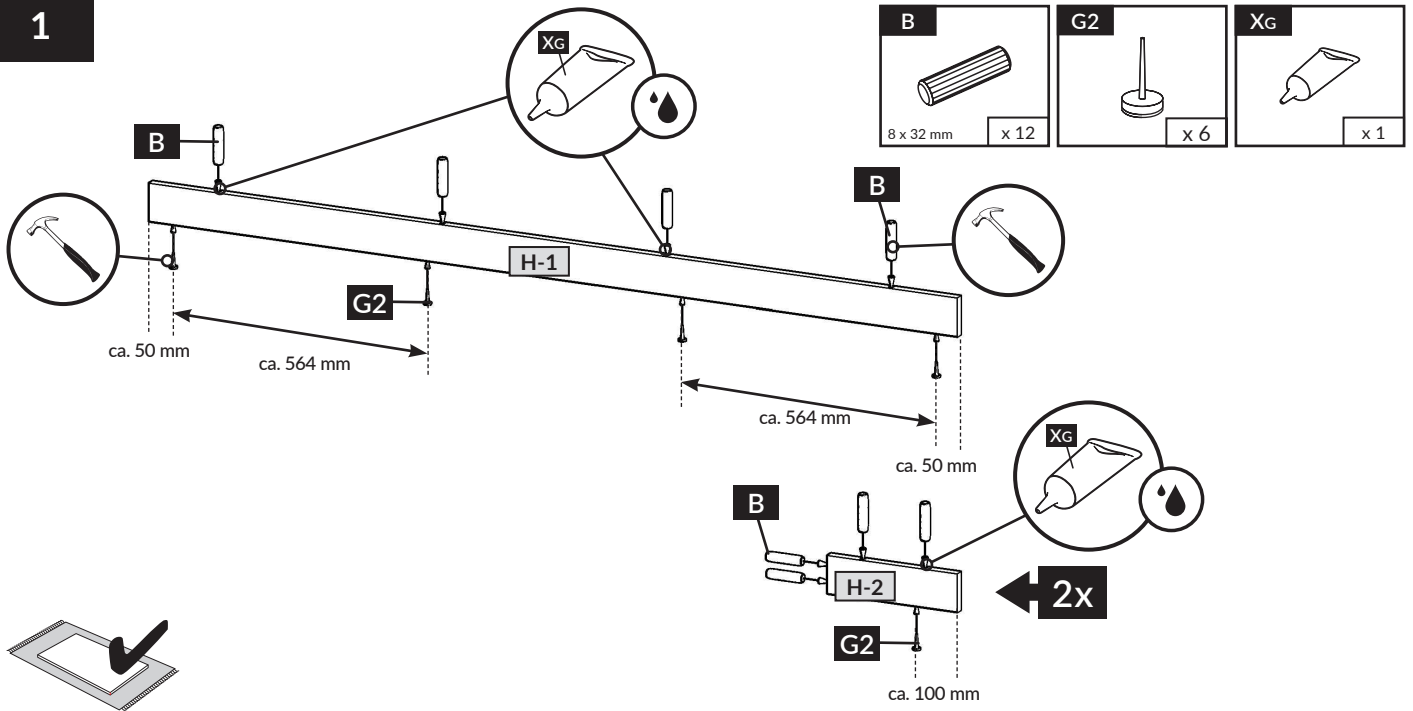

2

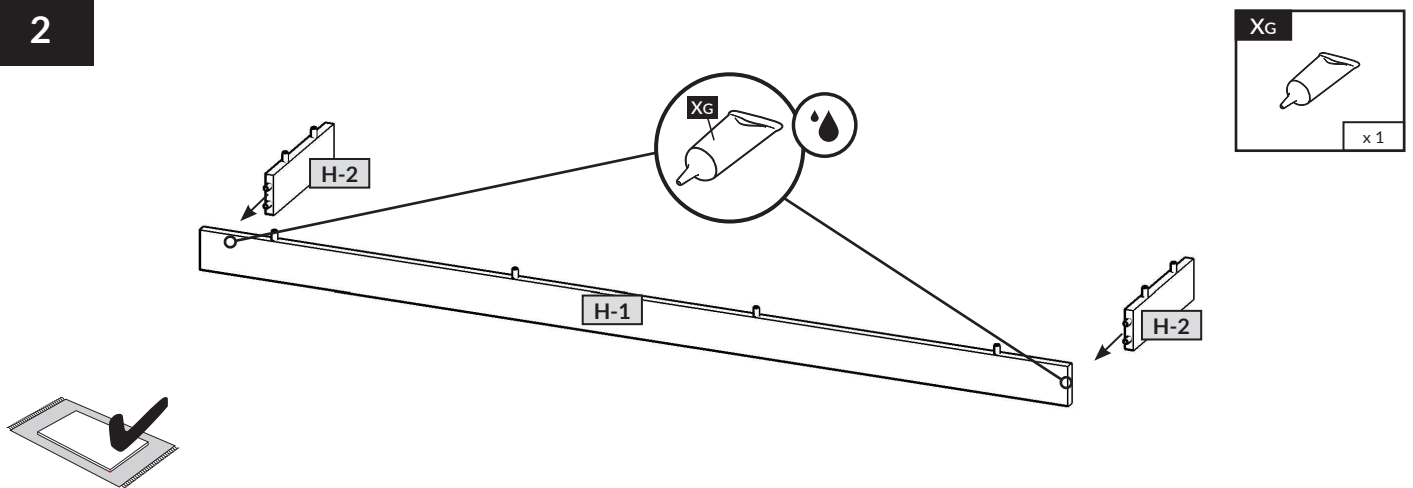

3

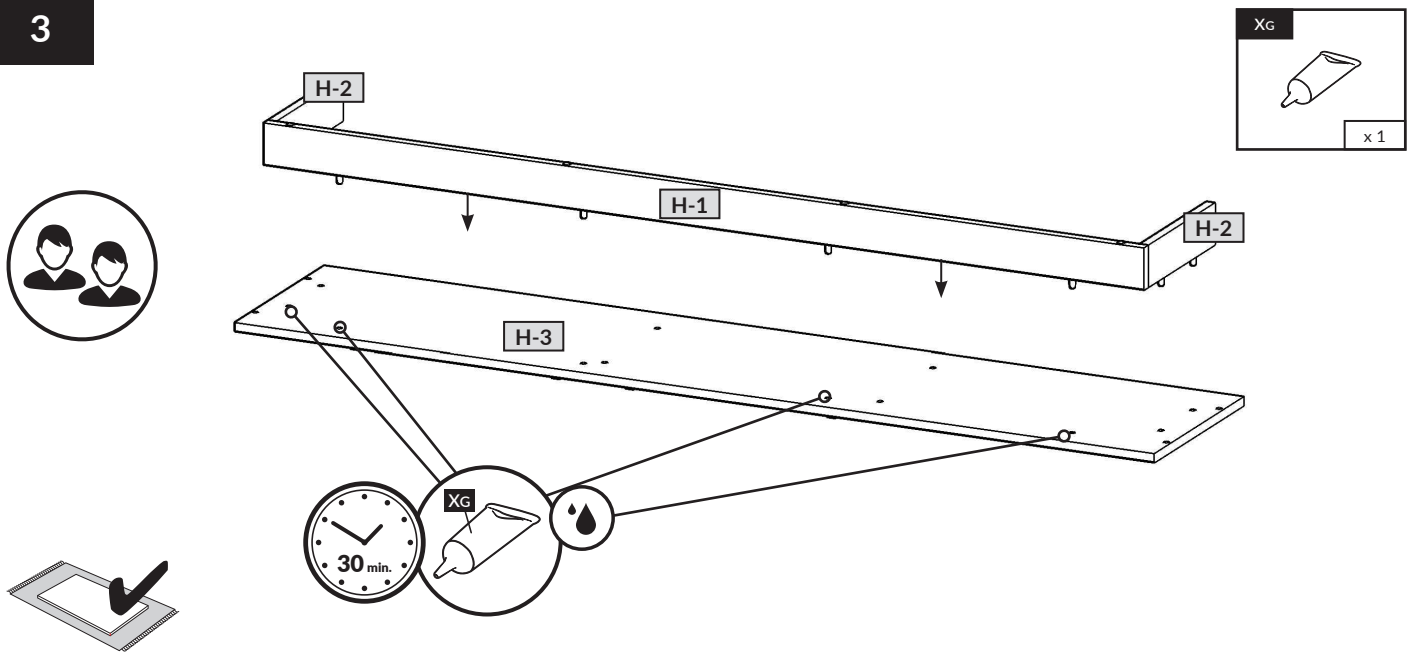

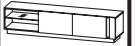

4

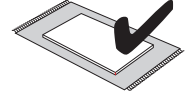
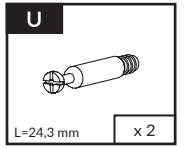
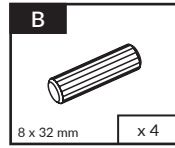
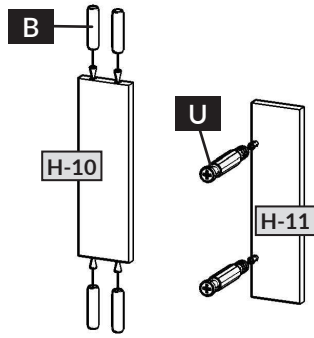
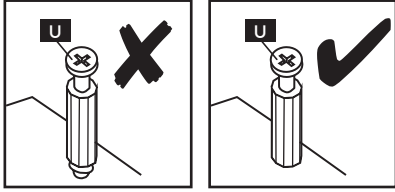

5

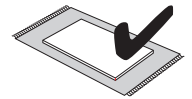
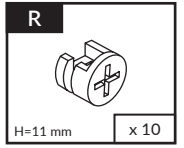
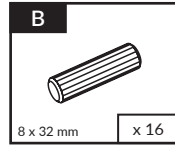
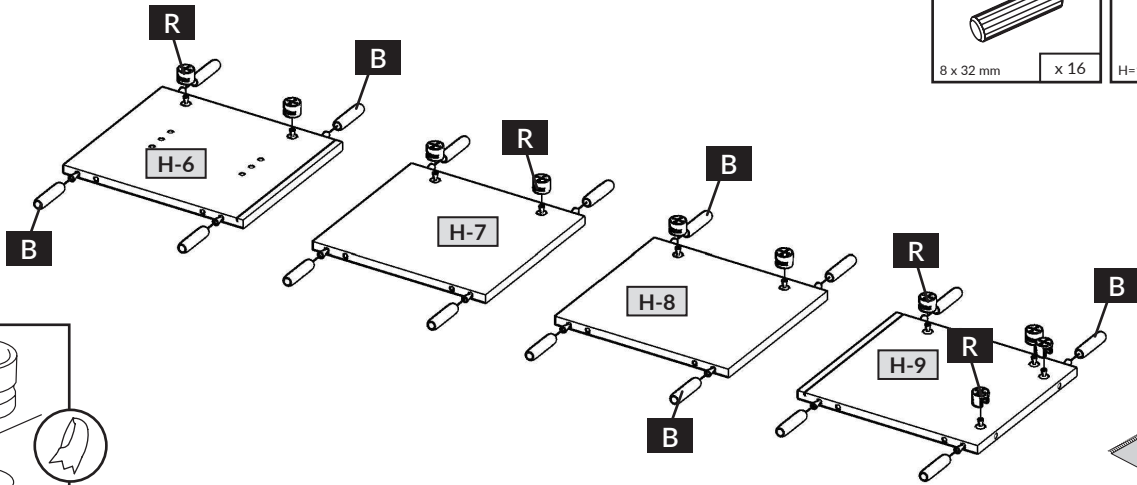
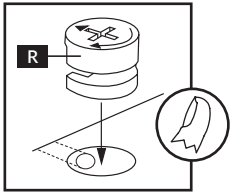

6

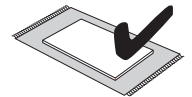
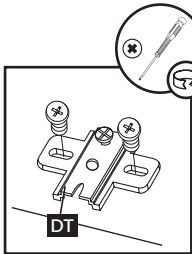
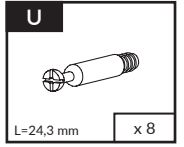
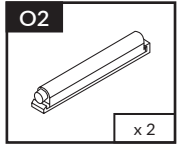
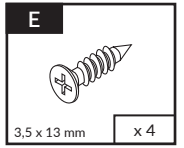
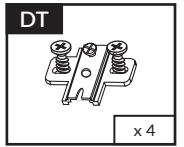
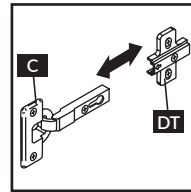
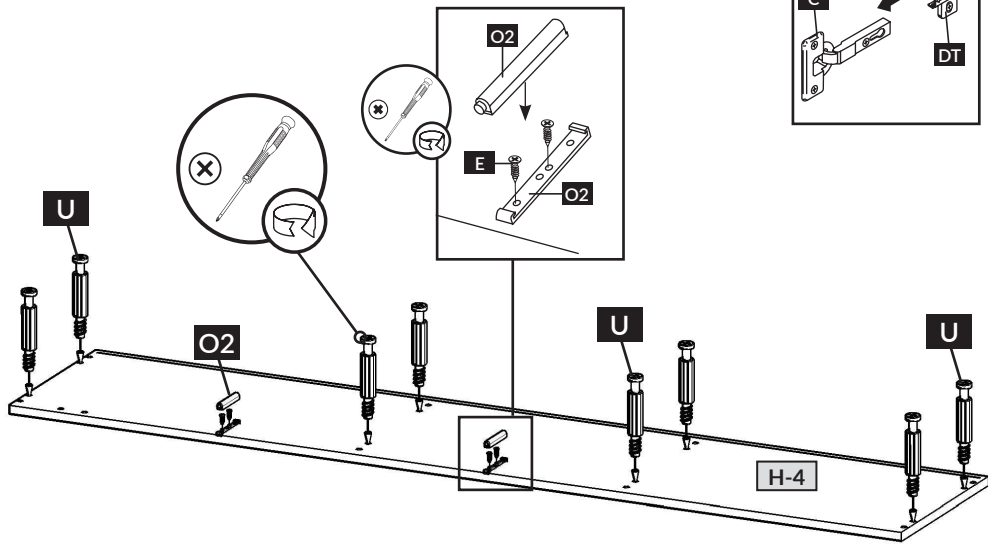
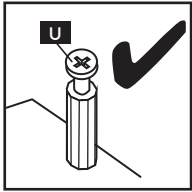
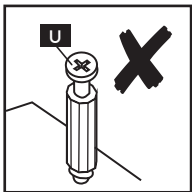

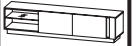

7

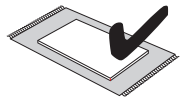
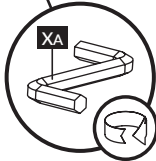
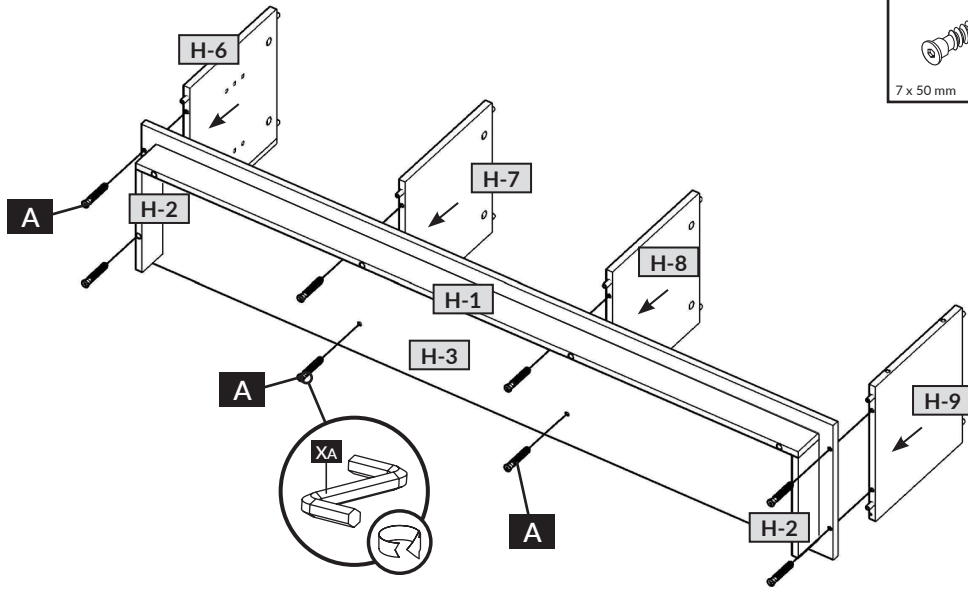
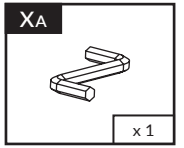
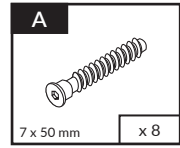

8

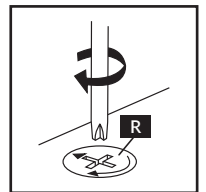
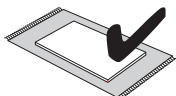
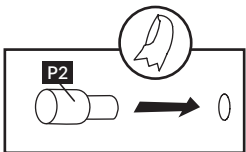
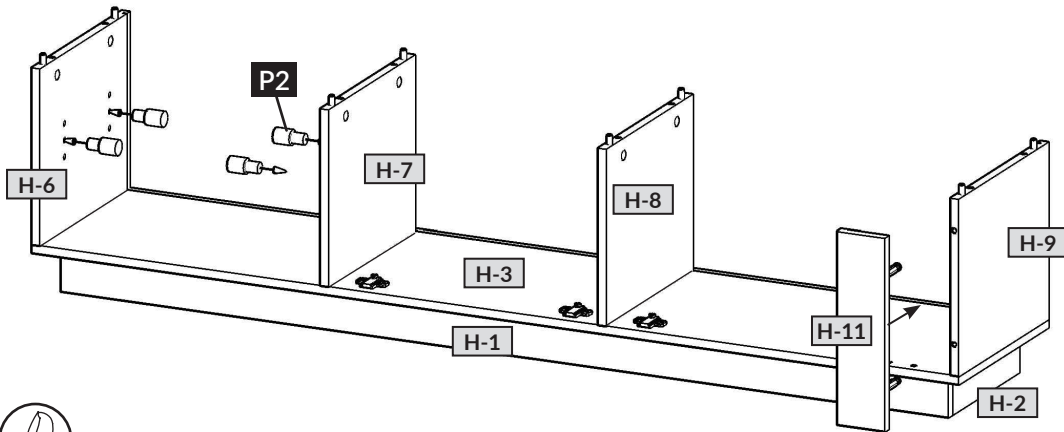
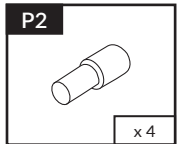

9

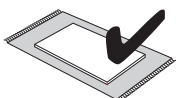
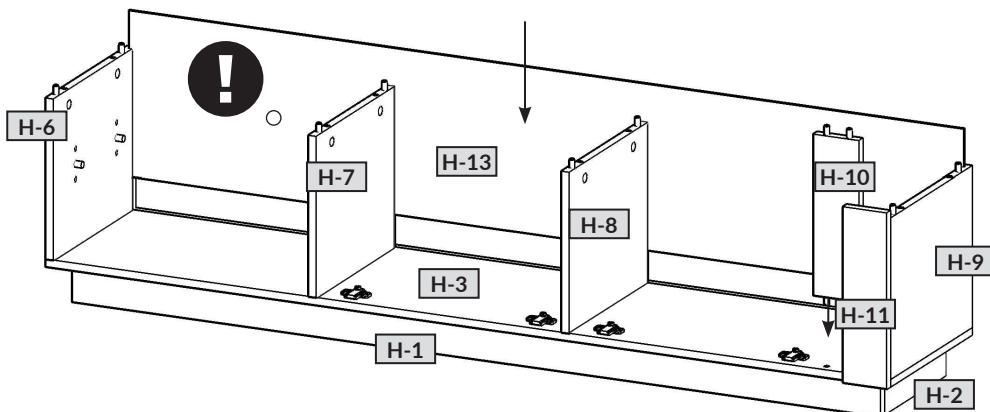

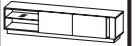

10

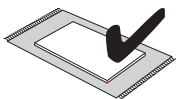
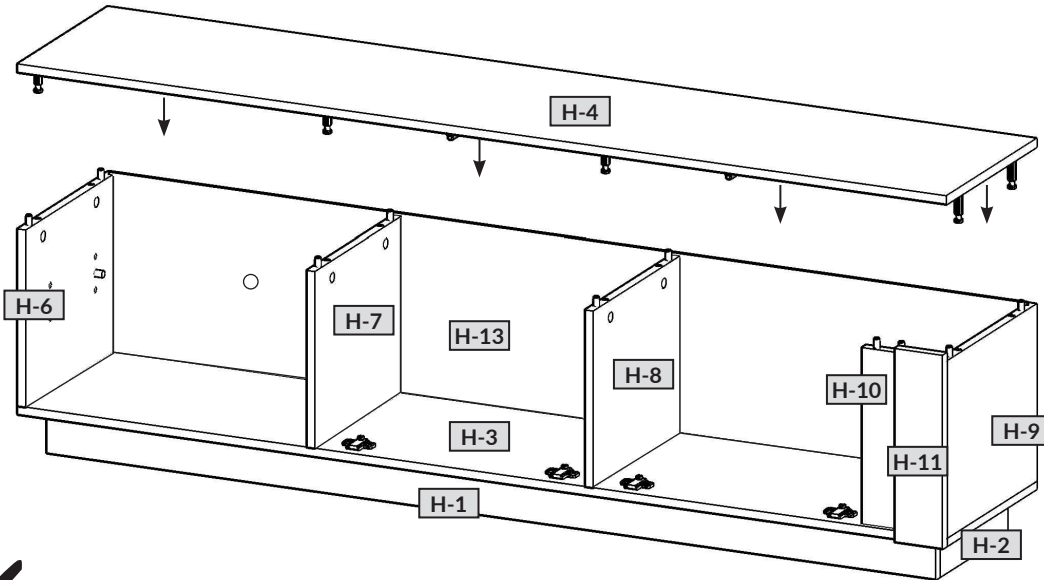
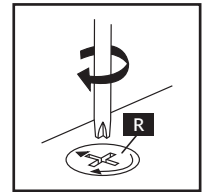

11

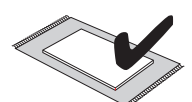
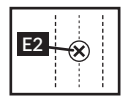
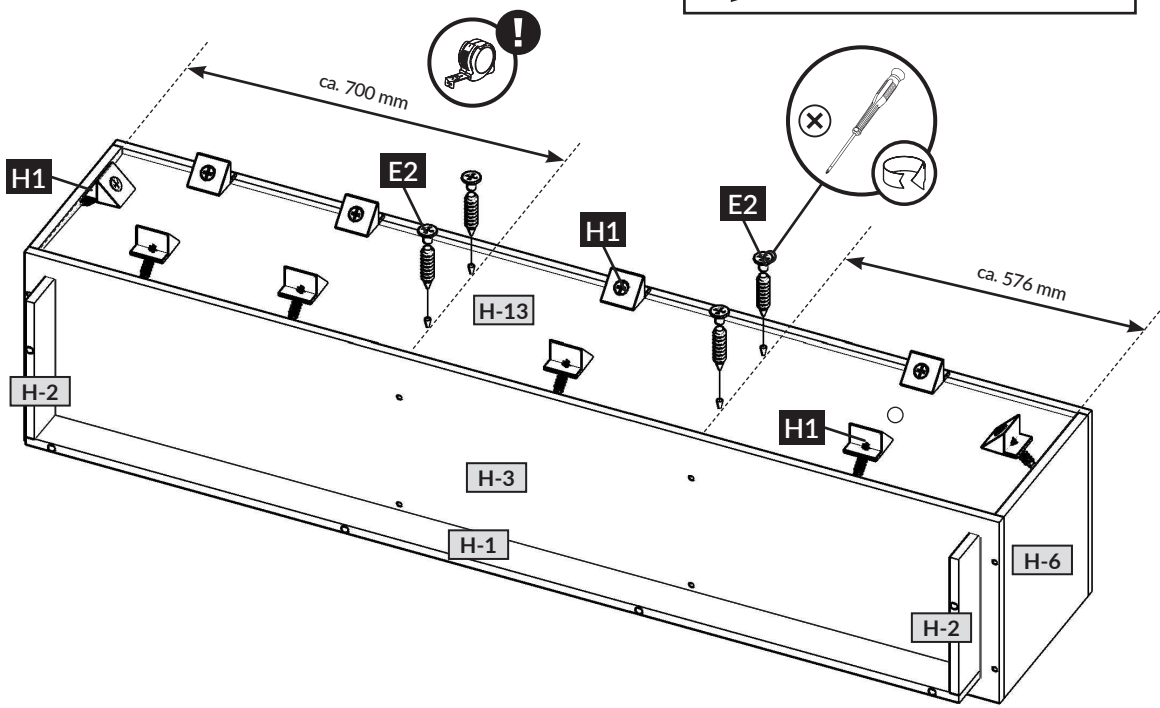
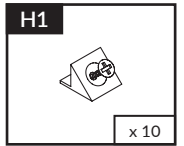
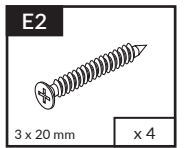
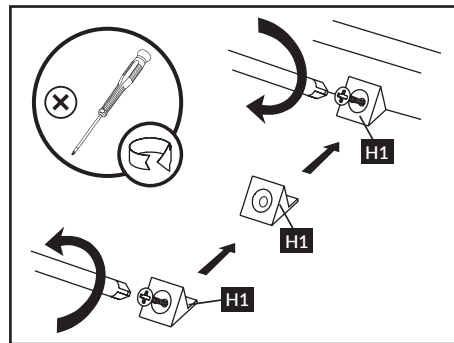
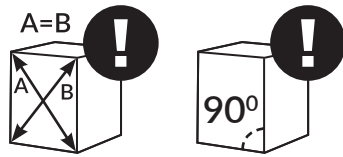

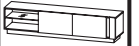



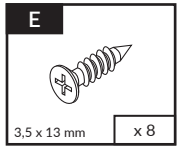
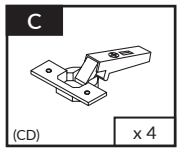
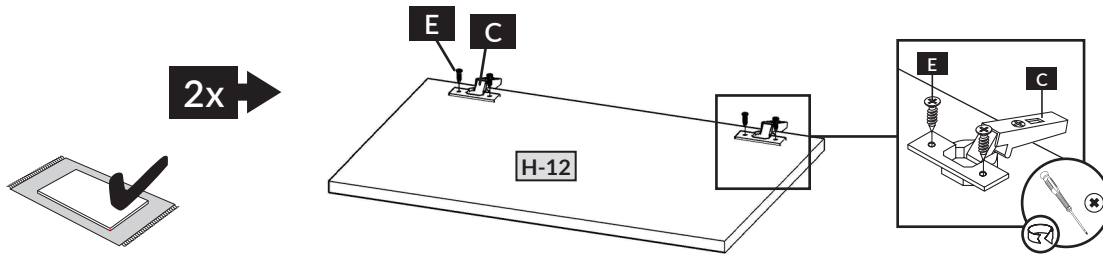



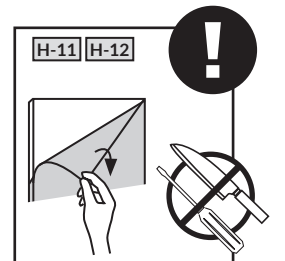
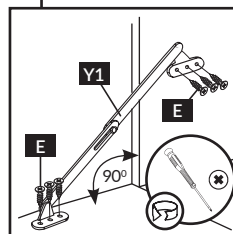
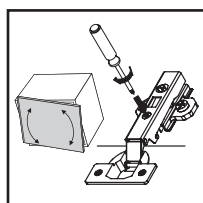
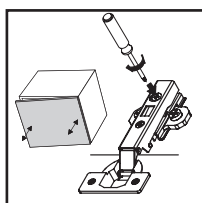
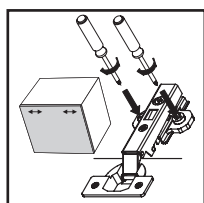
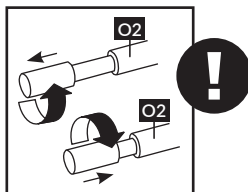
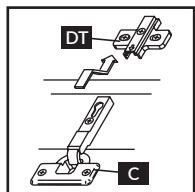
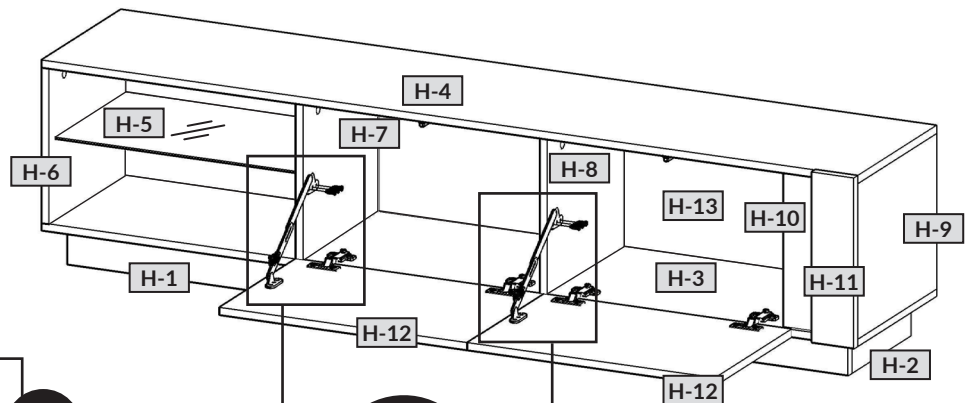
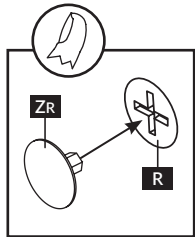
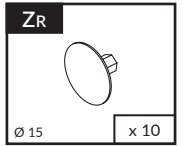
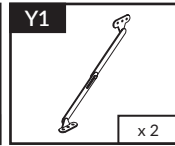
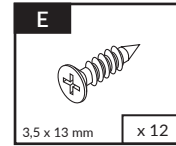

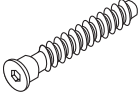

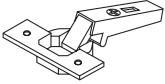
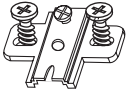
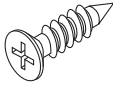

12

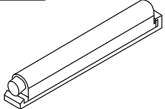
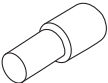

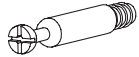
13

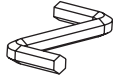

A  7 x 50 mm X ...	B  8 x 32 mm X ...	C  (CD) X ...
DT  X ...	E  3,5 x 13 mm X ...	E2  3 x 20 mm X ...
G2  X ...	H1  X ...	O2  X ...
P2  X ...	R  H=11 mm X ...	U  L=24,3 mm X ...
Y1  X ...	XA  X ...	XG  X ...
ZR  Ø 15 X ...		

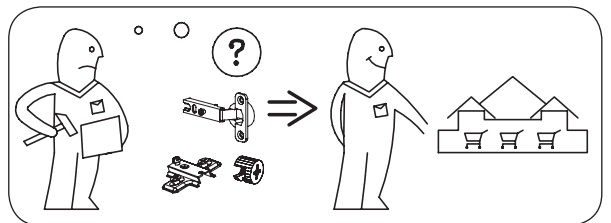
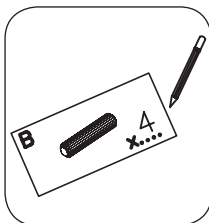

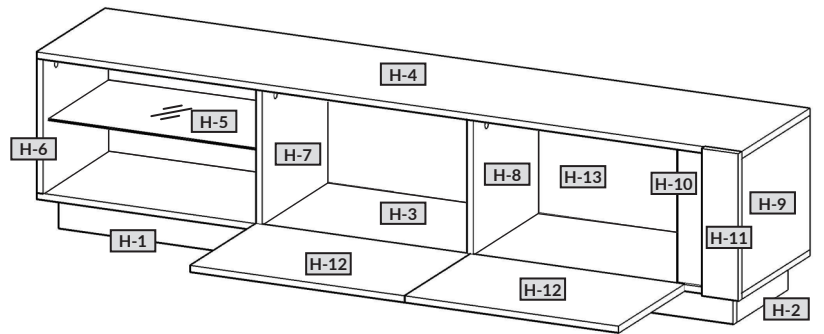

nr	↔ [mm]	↓ [mm]	∅ [mm]	Menge	Colli
H-1	1794	80	16	x 1	1/1
H-2	288	80	16	x 2	1/1
H-3	1874	384	16	x 1	1/1
H-4	1874	384	16	x 1	1/1
H-5	565	330	4	x 1	1/1
H-6	338	384	16	x 1	1/1
H-7	338	369	16	x 1	1/1
H-8	338	369	16	x 1	1/1
H-9	338	384	16	x 1	1/1
H-10	100	338	16	x 1	1/1
H-11	96	370	16	x 1	1/1
H-12	568	370	16	x 2	1/1
H-13	1852	352	3	x 1	1/1

