

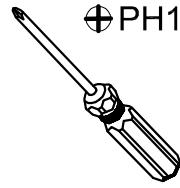

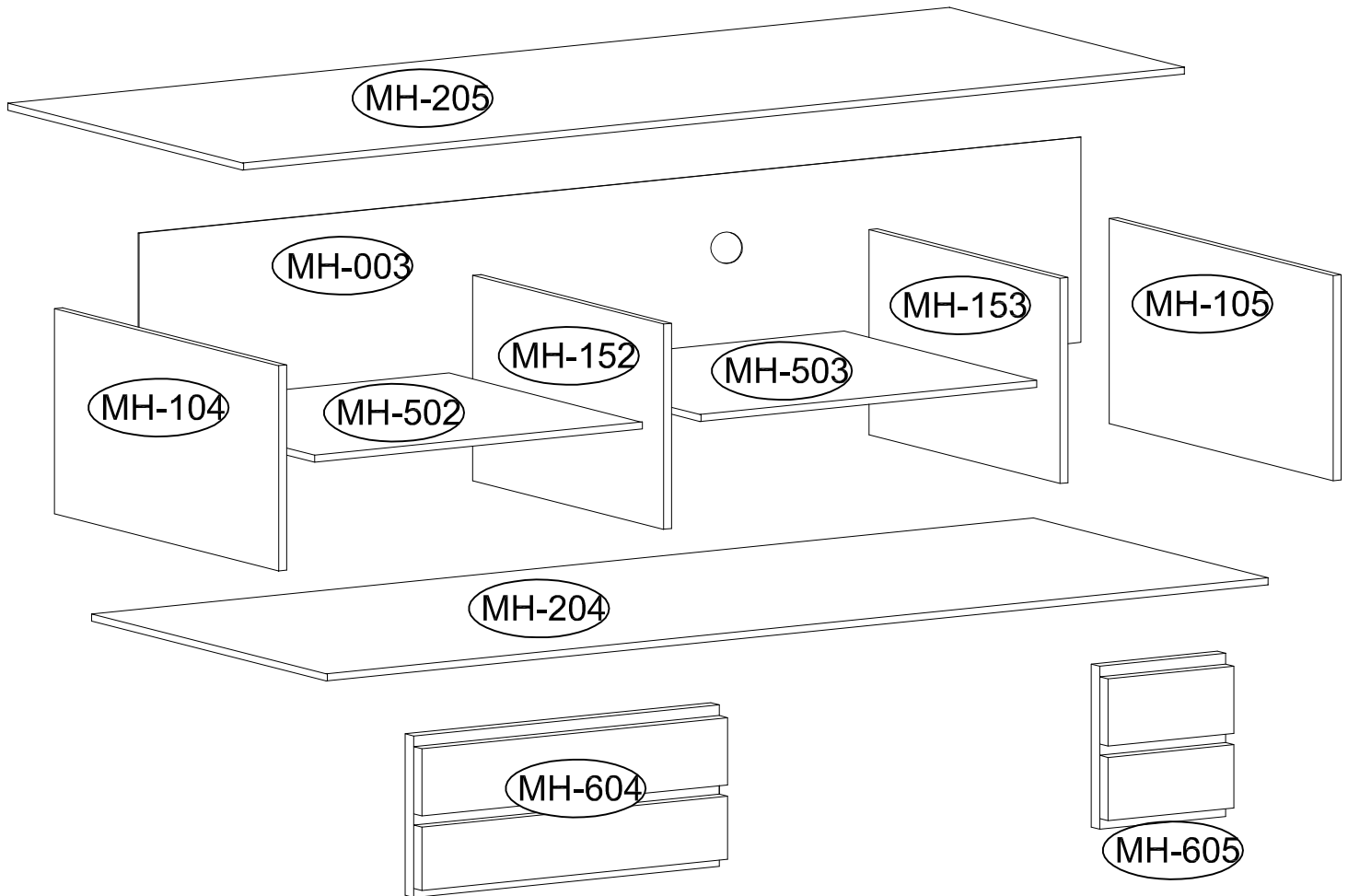

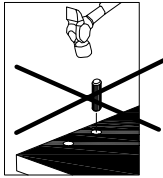

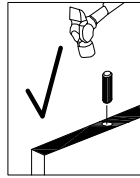
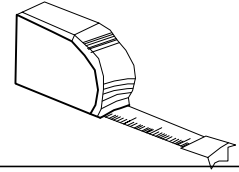
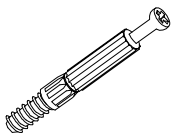
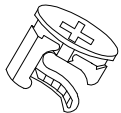

⊕PH2

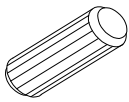
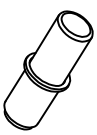
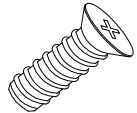

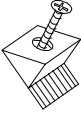
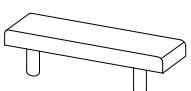
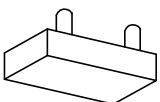
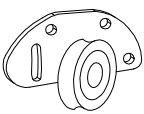
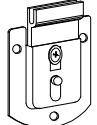
⊕PH1

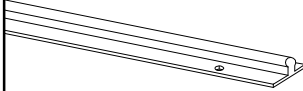

<p>4066</p>  <p>Ø6.5x36.5mm x16</p>	<p>3996</p>  <p>Ø15x16mm x16</p>	<p>136236</p>  <p>Ø20 x16</p>	<p>3989</p>  <p>Ø8x30mm x16</p>
<p>4017</p>  <p>x8</p>	<p>3879</p>  <p>Ø6.3x13mm x4</p>	<p>3923</p>  <p>Ø4,0x16mm x28</p>	<p>4044</p>  <p>x12</p>
<p>4057</p>  <p>x8</p>	<p>IN01112</p>  <p>H-20 mm x2</p>	<p>IN01007</p>  <p>x4</p>	<p>IN01006</p>  <p>x4</p>
<p>30585</p>  <p>x1</p>	<p>83658</p>  <p>x2</p>	<p>3912</p>  <p>Ø3,0x13mm x10</p>	

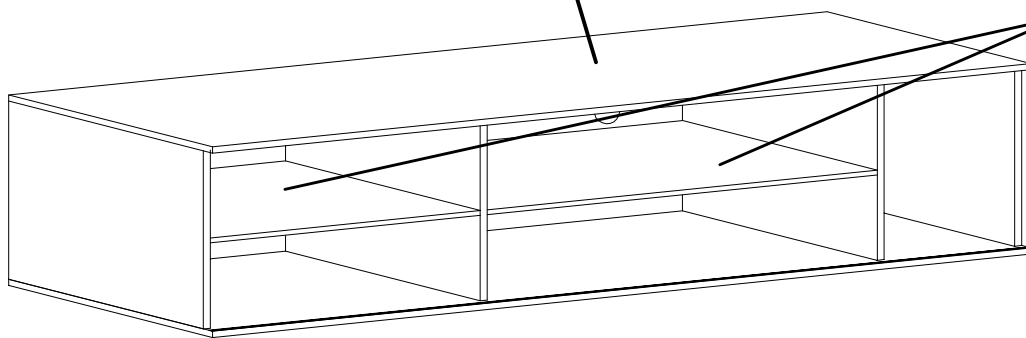
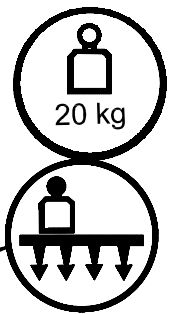
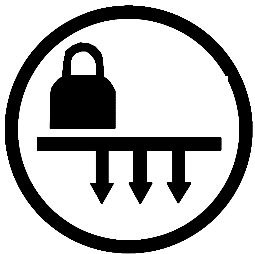

# 1

4057



x8

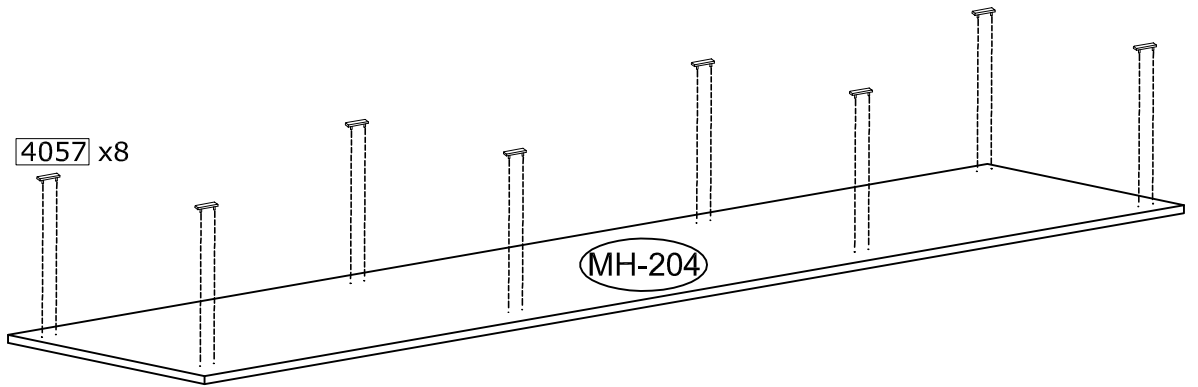
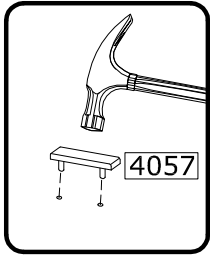

# 2

4066



x8

83658



x1

3912



3,0X13 x5

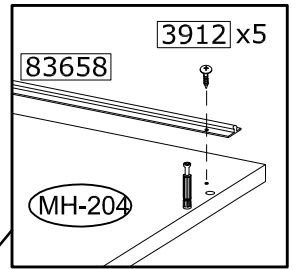
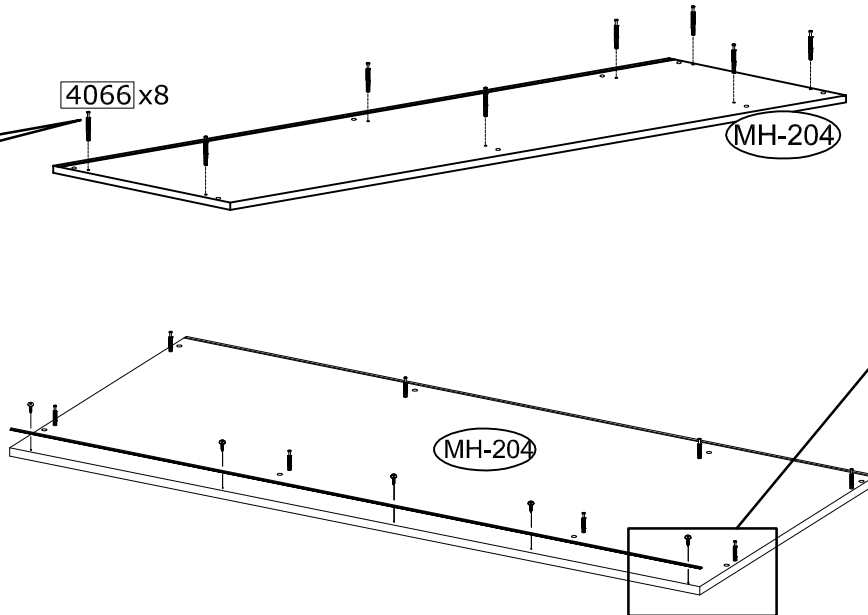
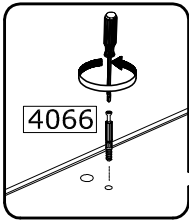

# 3

4017



W-2

3989



Dx8

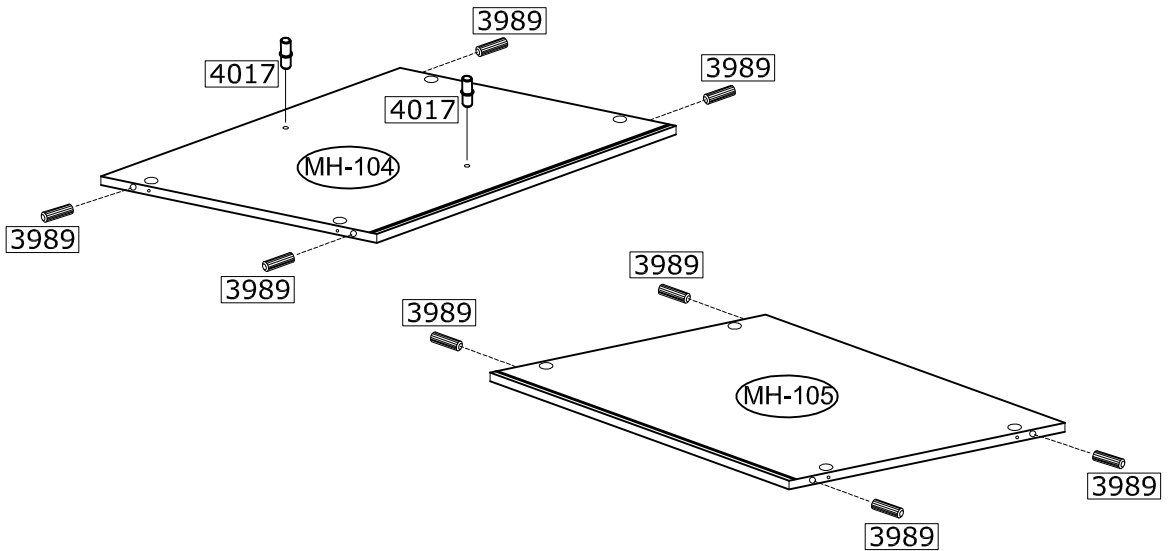
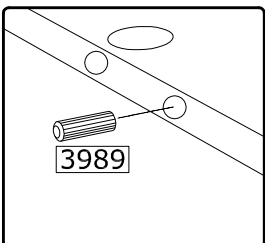
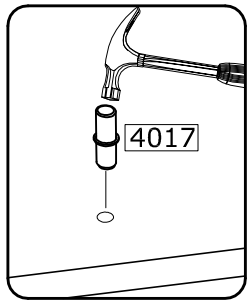

# 4

4017  x4	3989  x4		
--	--	--	--

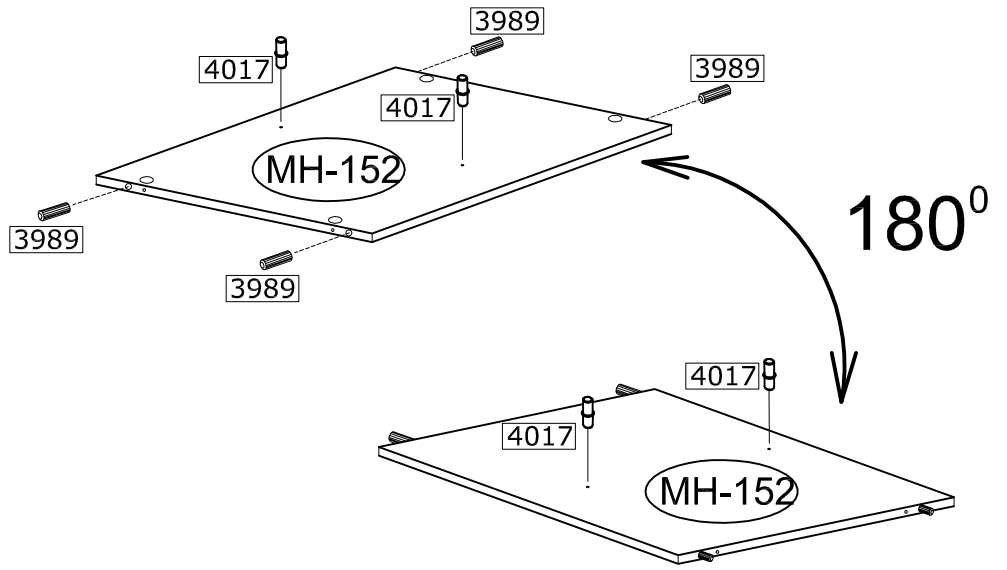
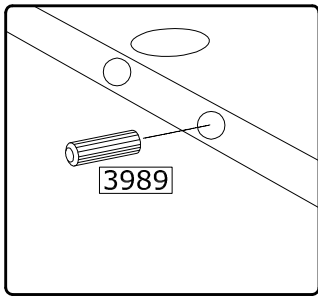
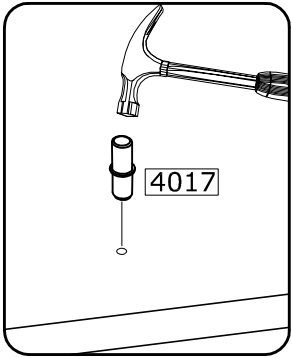

# 5

4017  x2	3989  x4		
---	---	--	---

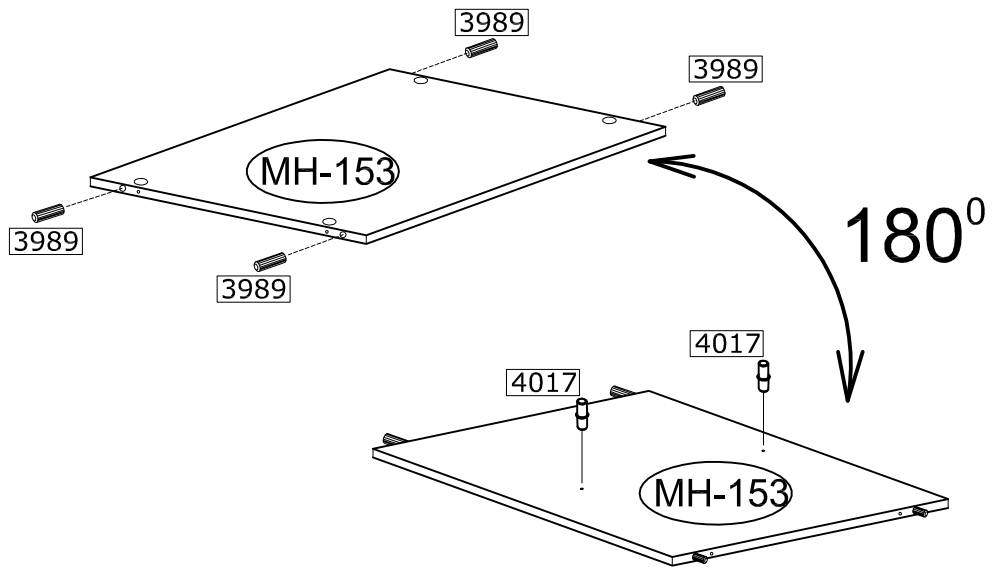
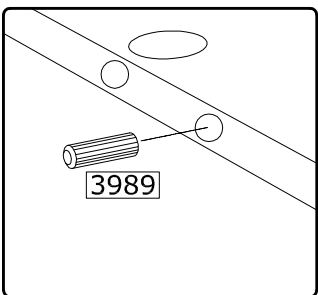
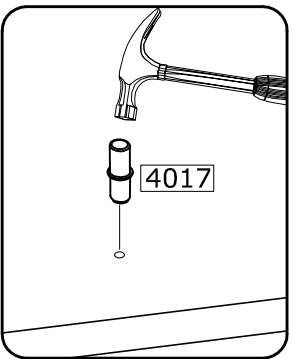

# 6

4066  x8	83658  x1	3912  3,0X13 x5	
--	---	---	--

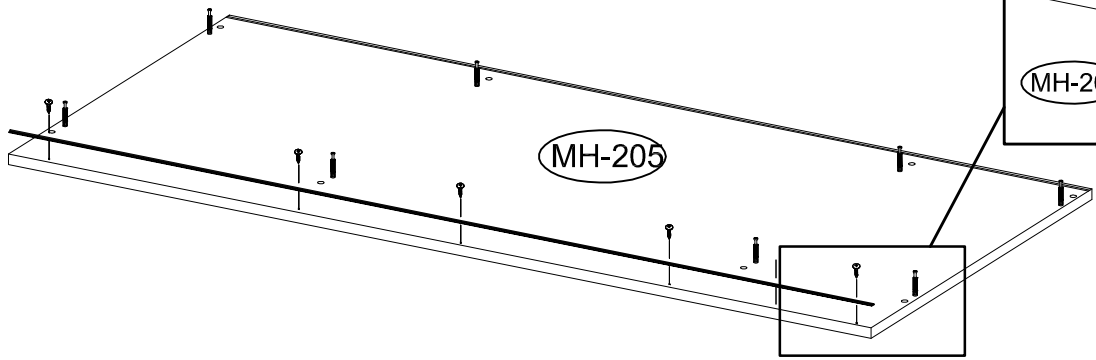
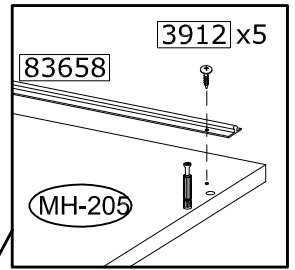
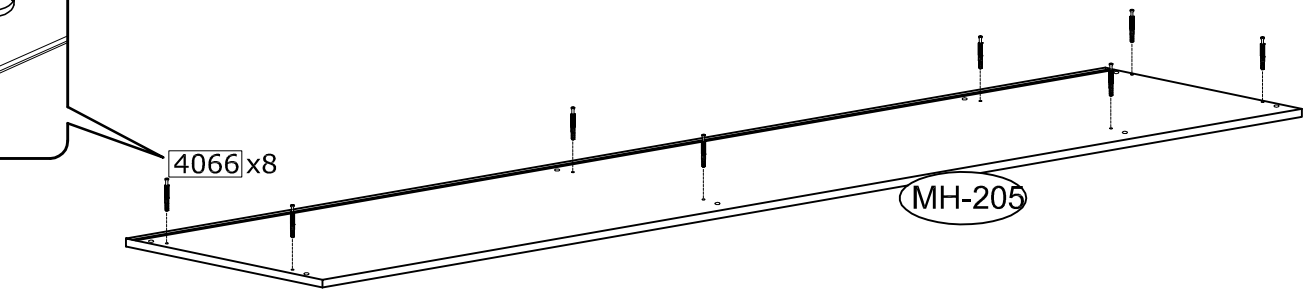
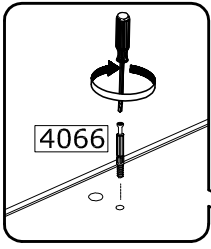

# 7

3996  x8	136236  x8		
---	---	--	---

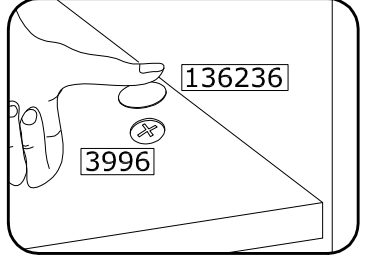
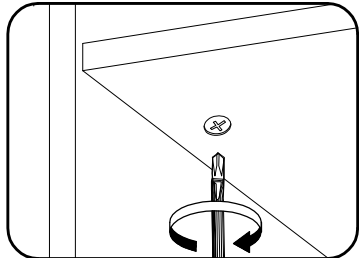
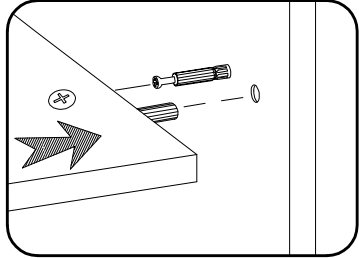
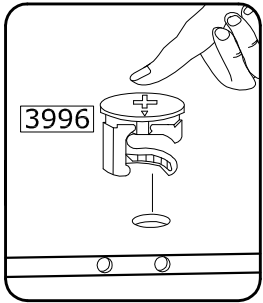
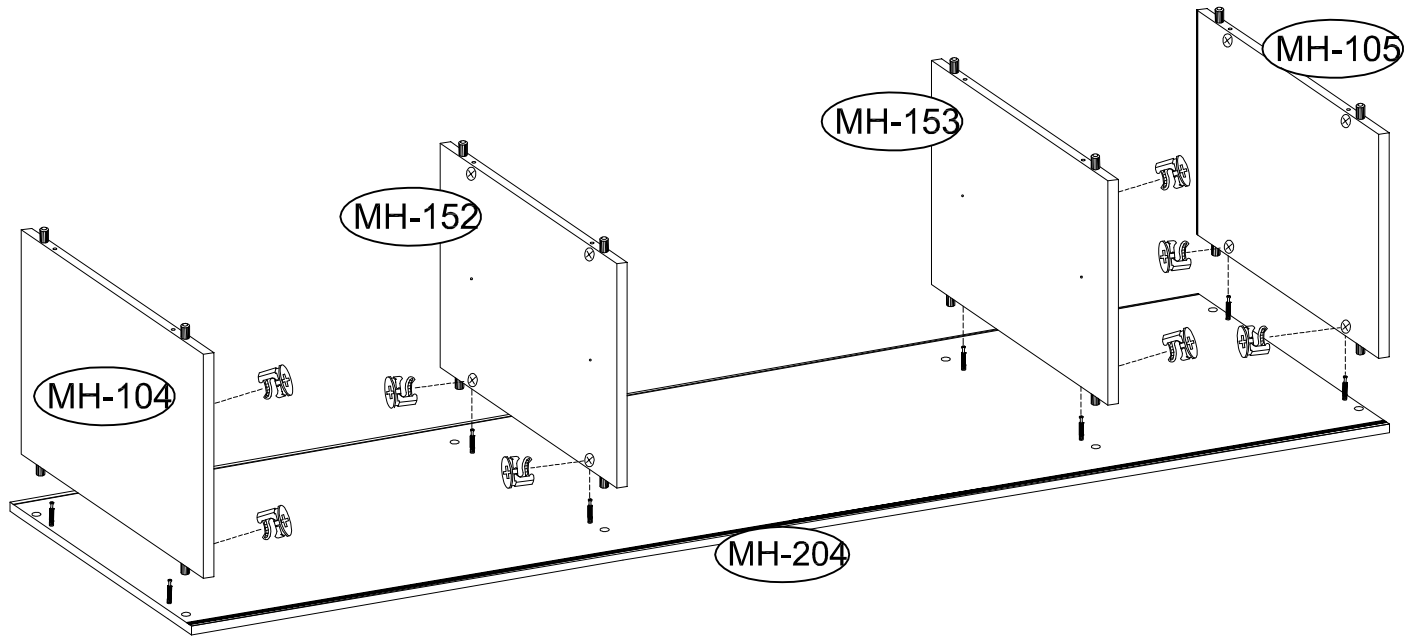

# 8

30585  x1		
---	--	--

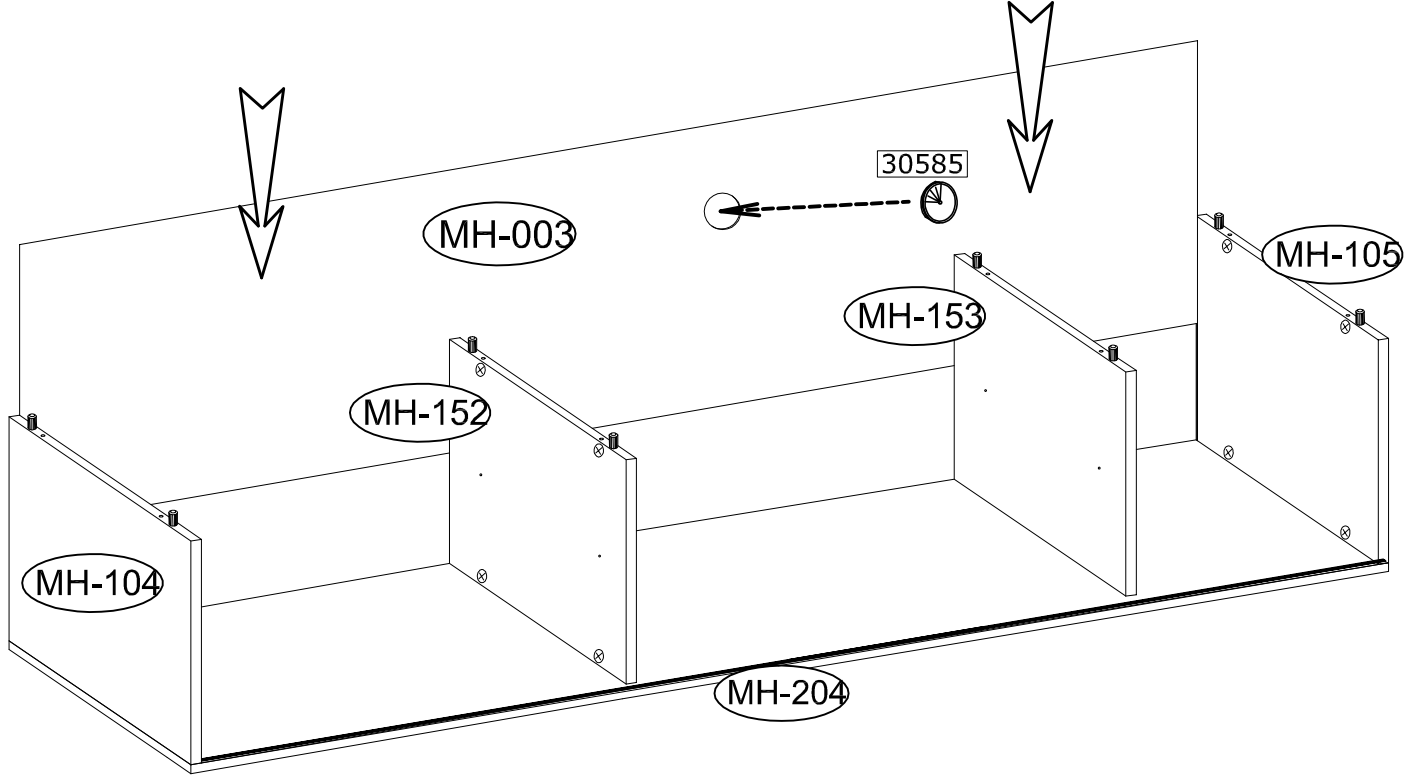

# 9

3996  x8	136236  x8	
--	--	---

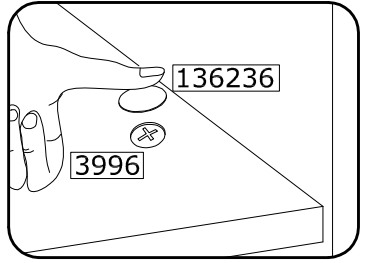
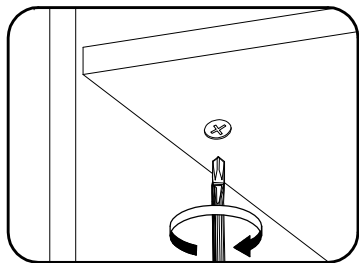
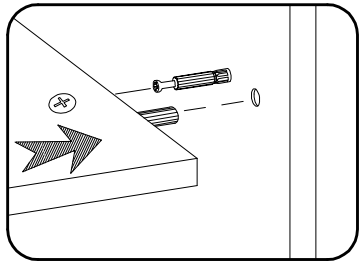
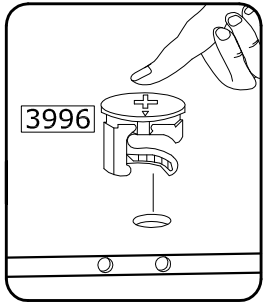
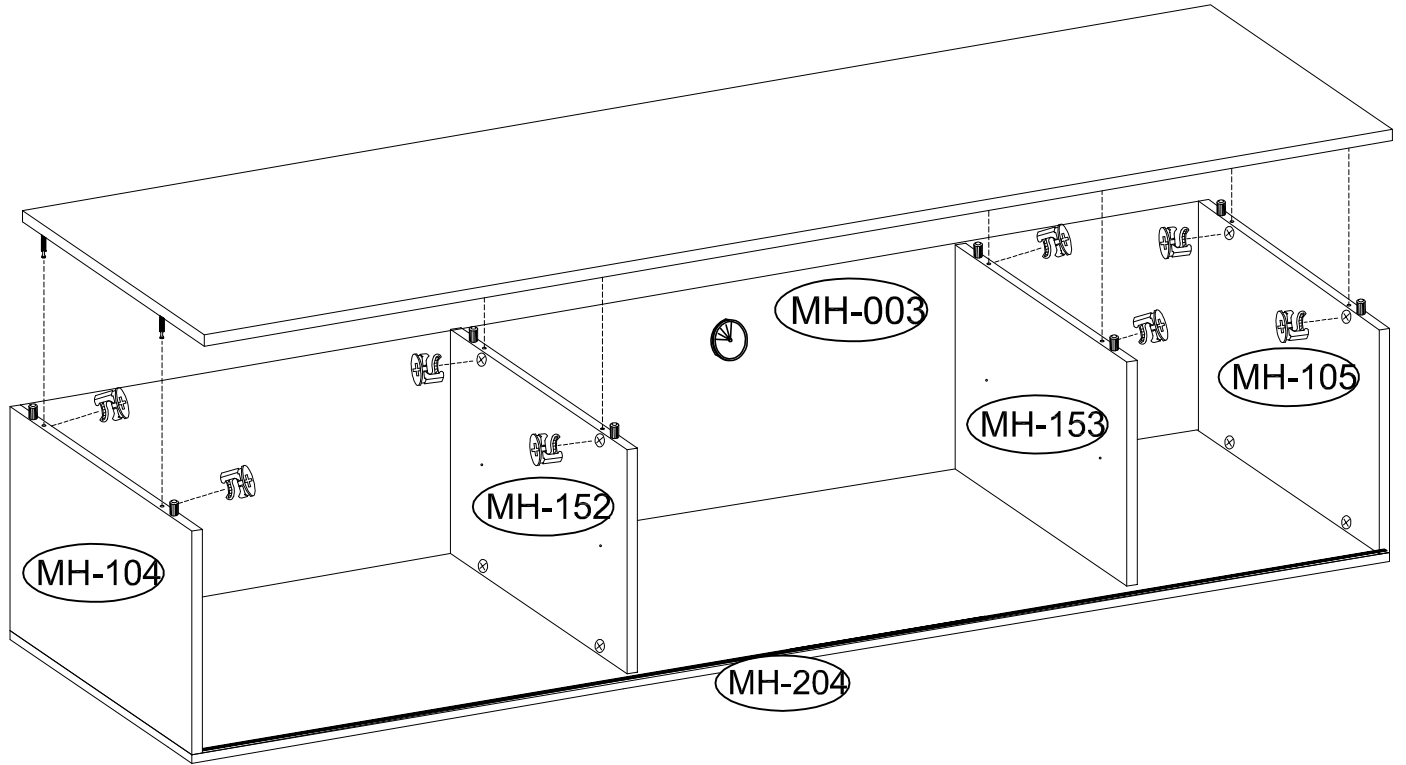

# 10

4044

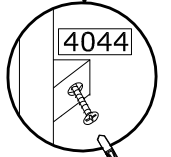
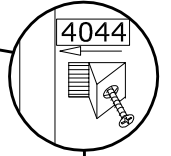
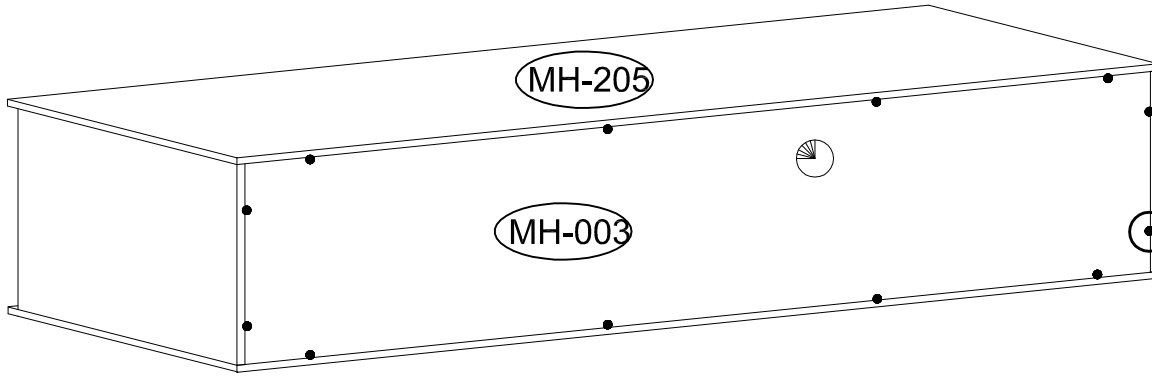
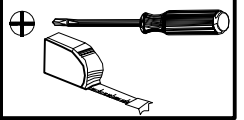

# 11

IN01006



IN01007



3923



3879

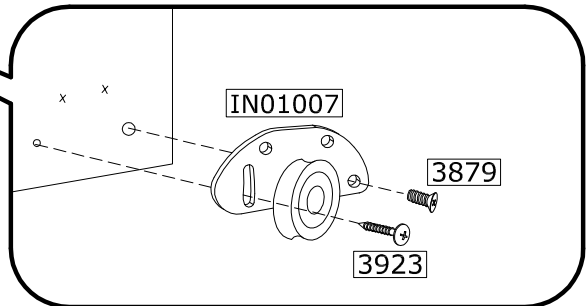
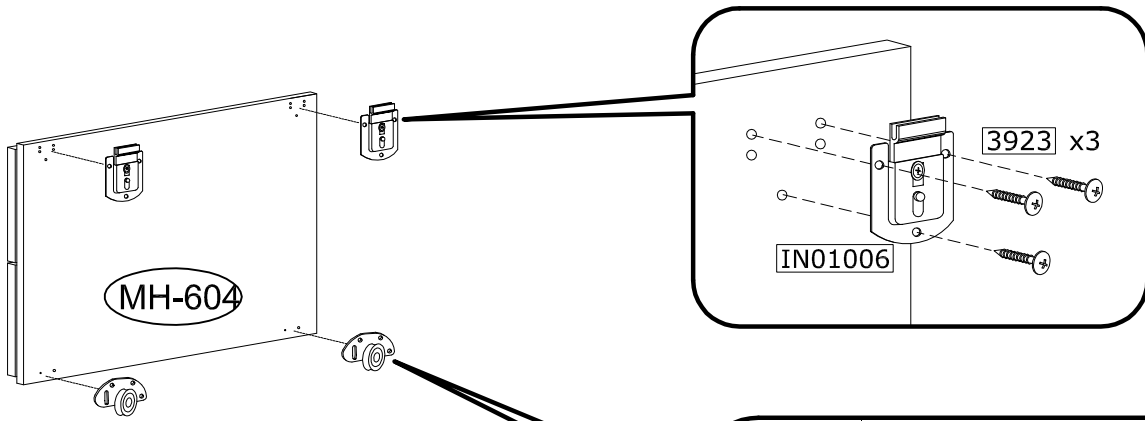



# 12

IN01007



x2

IN01007



x2

3923



x8

3879



x2

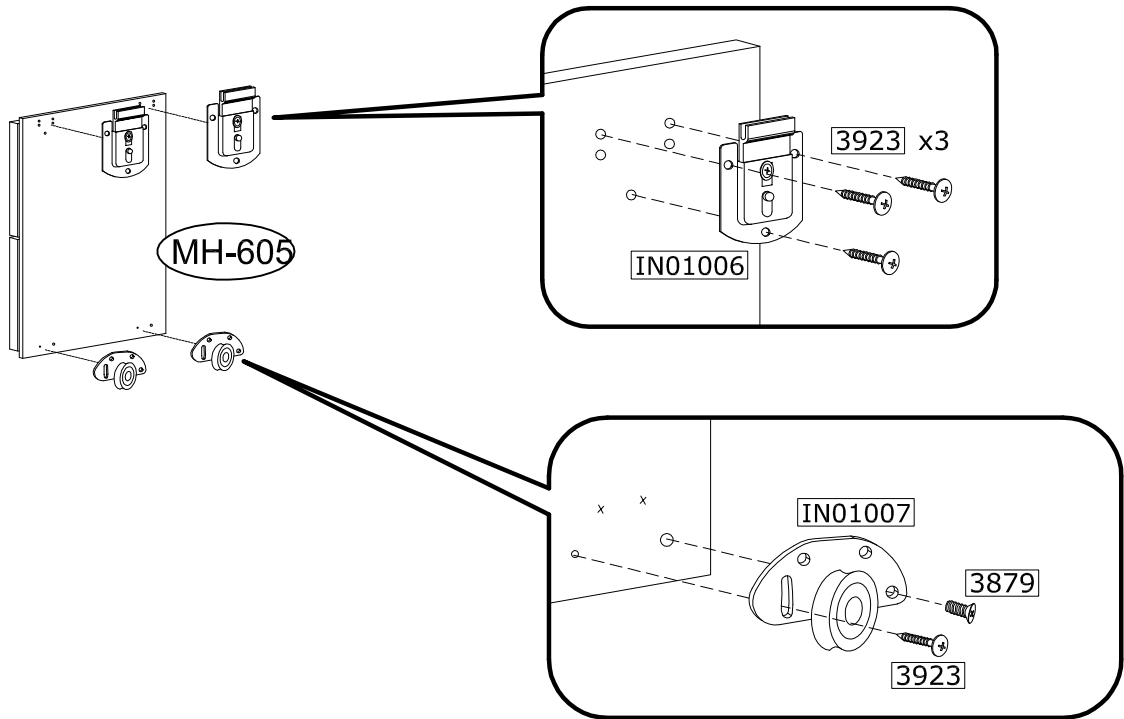

# 13

IN01112



x2

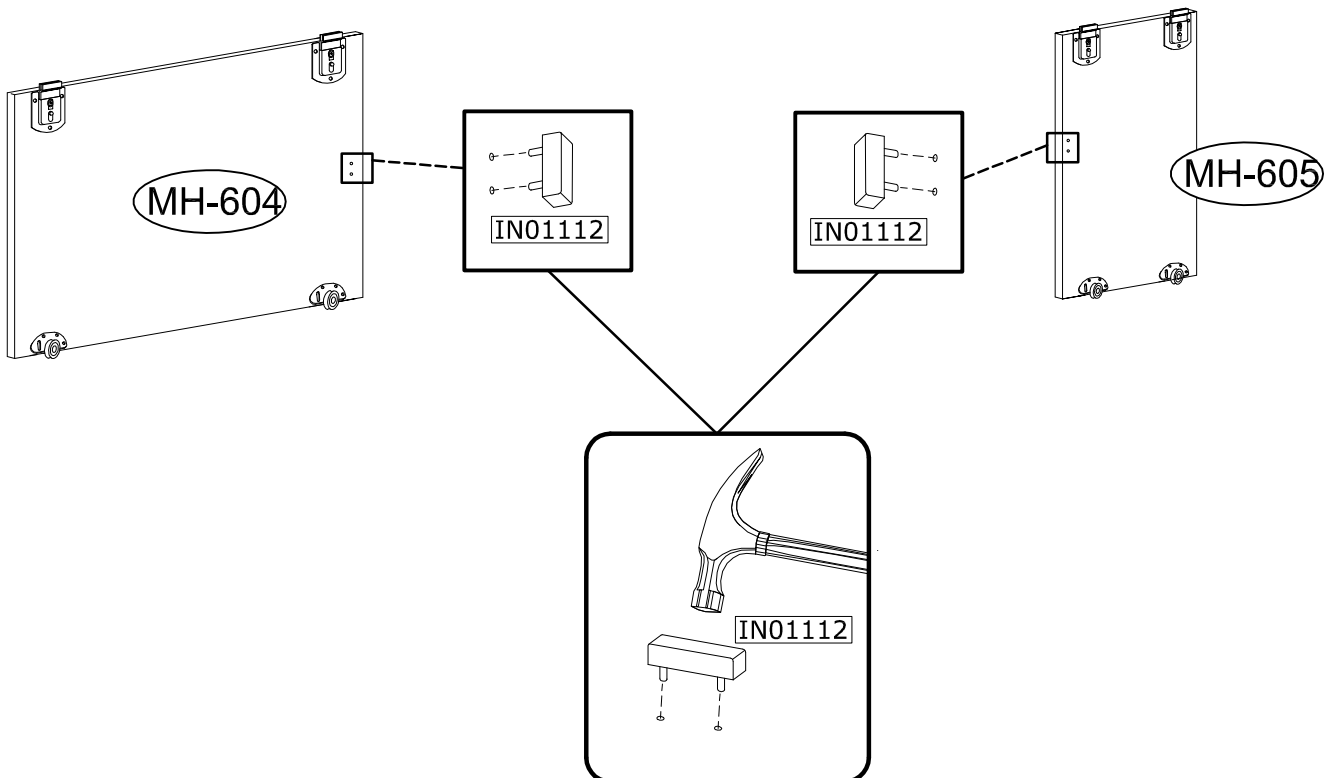

# 14

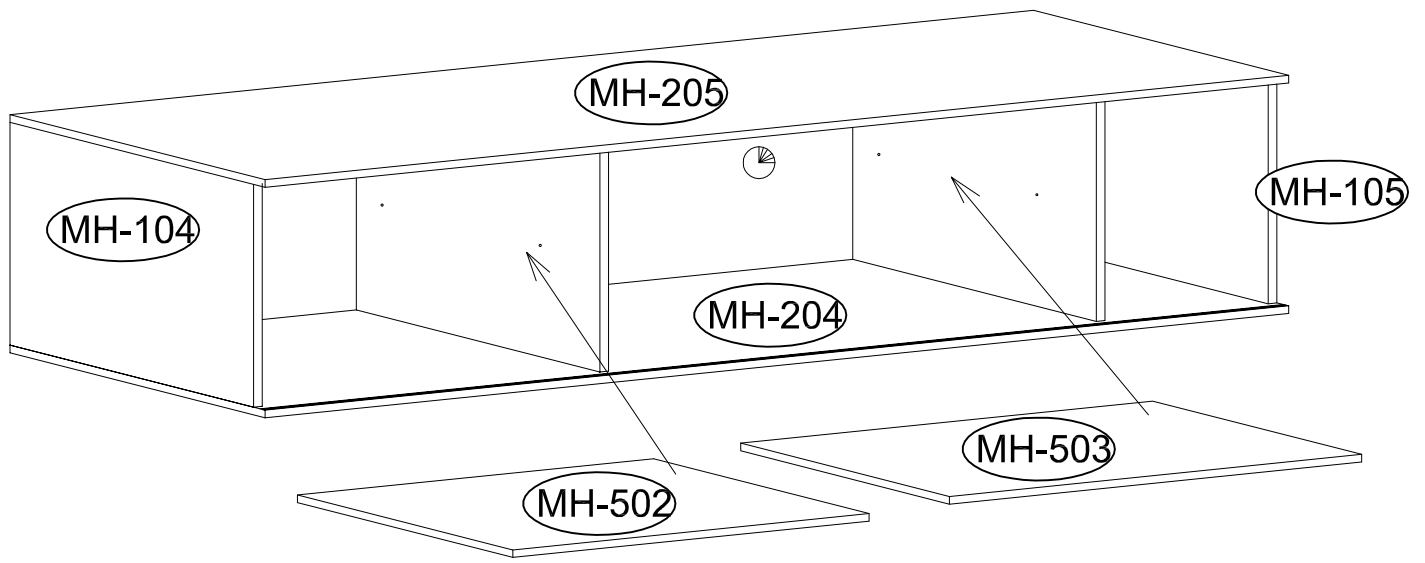

# 15

3923

