

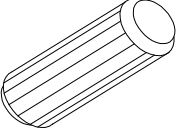

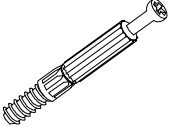



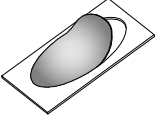
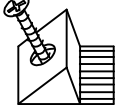
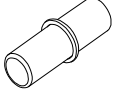
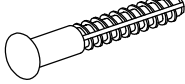

3989  Ø8x30mm x22	4066  Ø6.5x36.5mm x44	3996  x44	136239  Ø20 x20
4044  x18	4017  x8	IN01157  x12	3892  Ø4.0x25mm x16
3879  Ø6.3x13mm x8	3877  Ø6.0x13mm x12	71900  75x15x32 mm x2	3918  Ø3.5x16mm x16
136858  x4	136917  x4	202689  x8	3804  x3 KPL

1

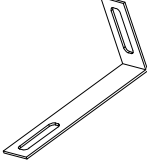

2

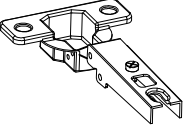
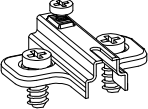
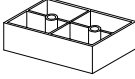
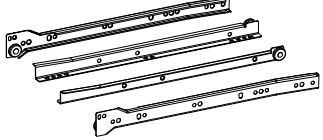
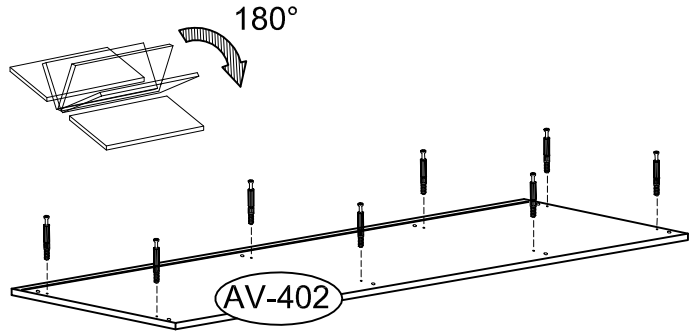
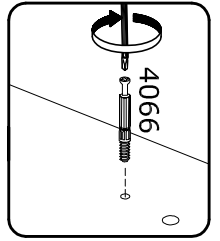
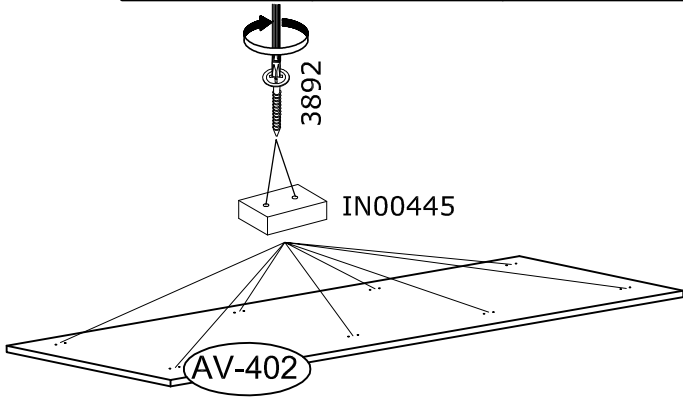
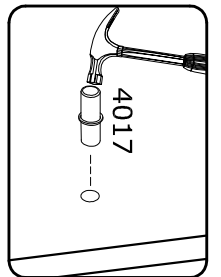
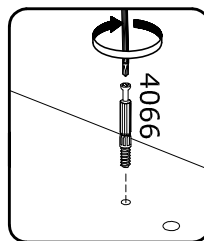
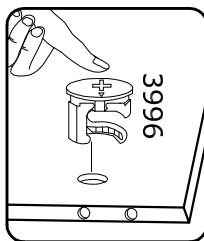
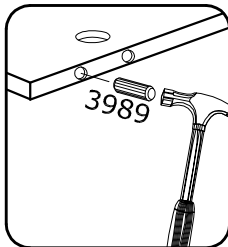
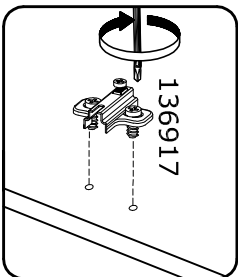
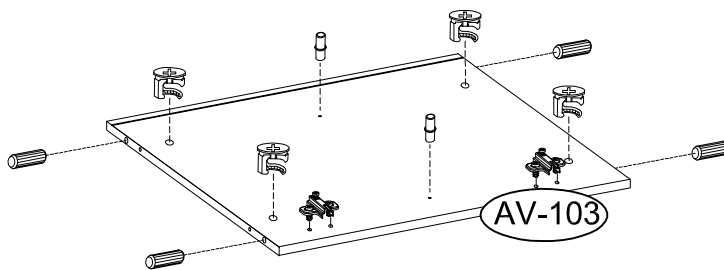
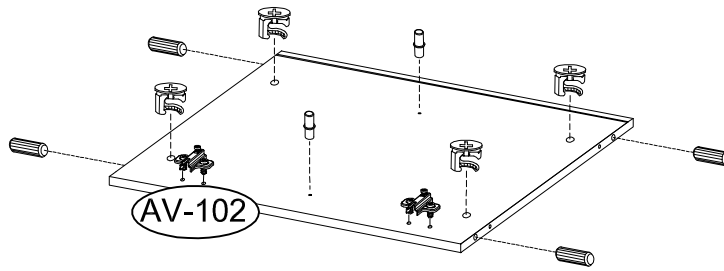
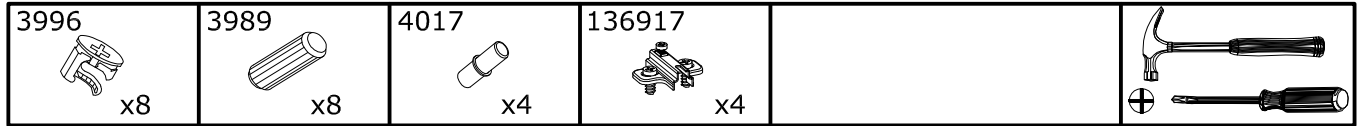

3

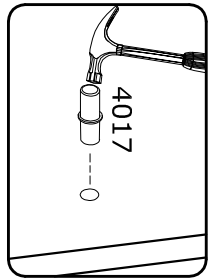
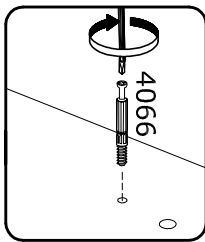
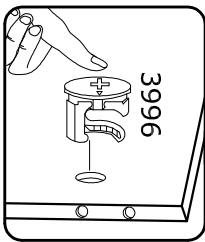
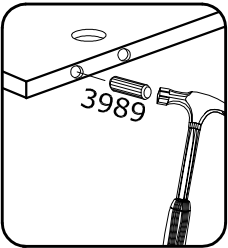
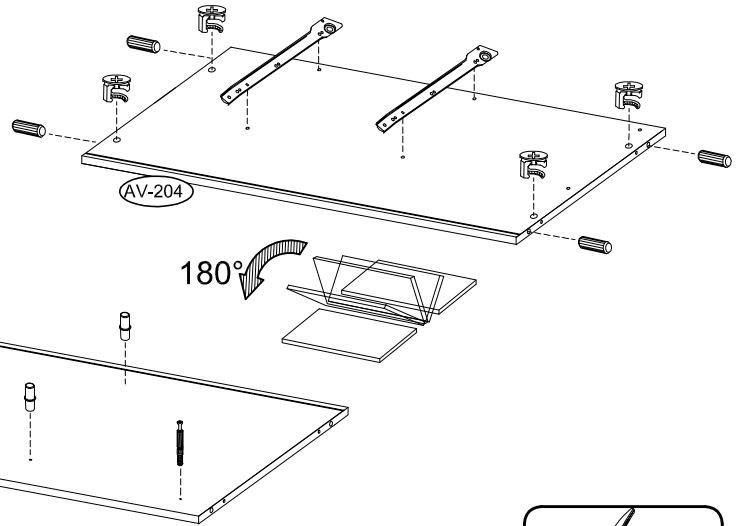
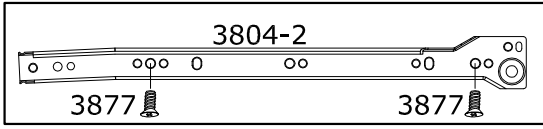
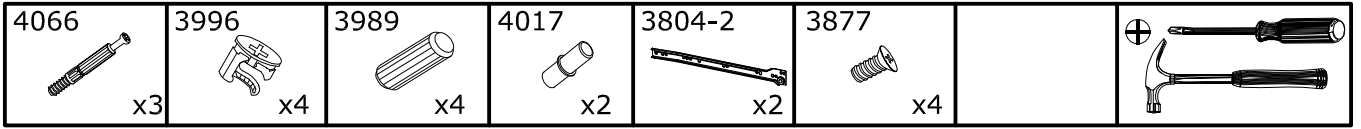

4

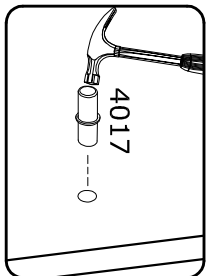
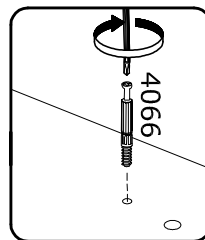
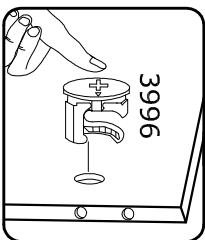
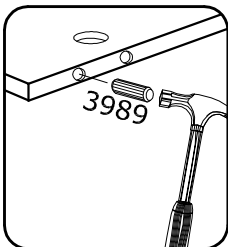
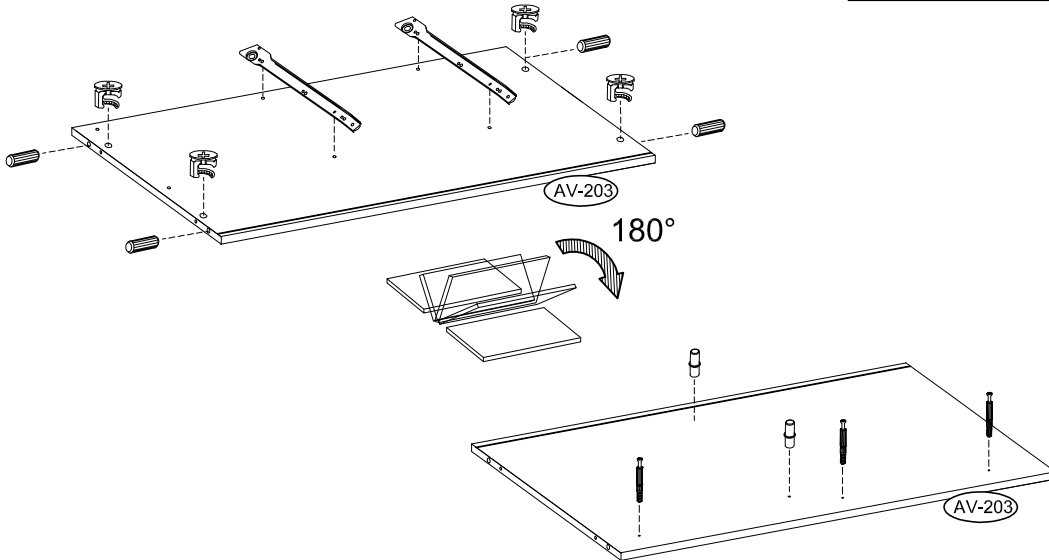
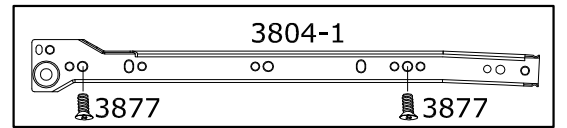
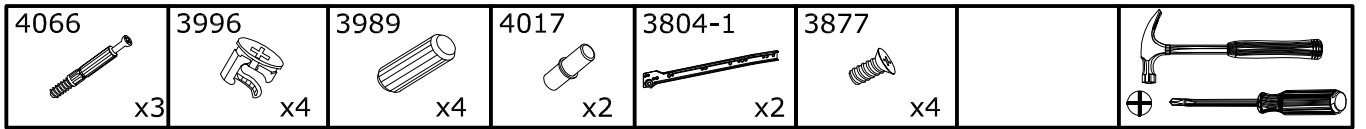

5

4066



x6

3996



x12



x2

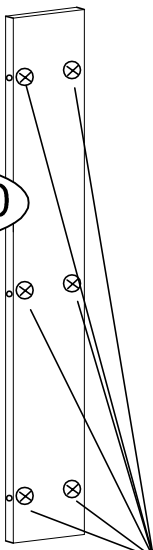

AV-850

x2

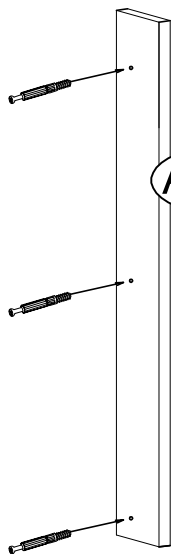

AV-851

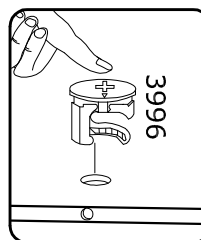

3996

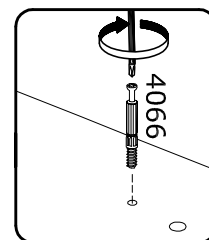

4066

6



x2

AV-850

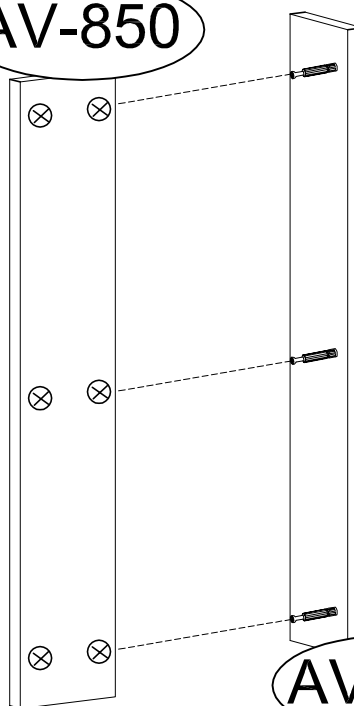

AV-851

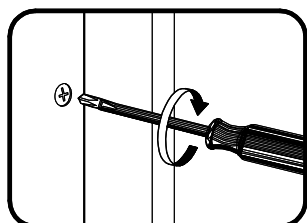
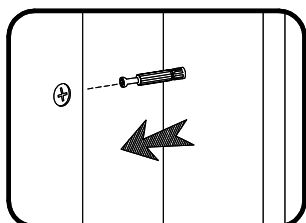

7

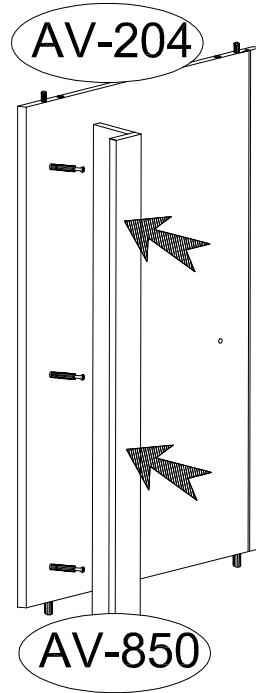
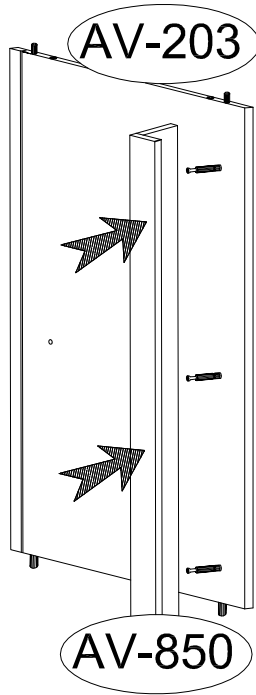
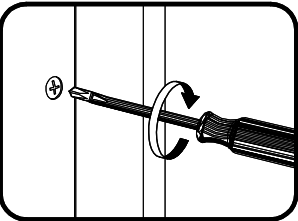
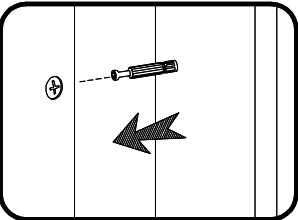

8

3989



x6

IN01157



x12

3918



x12

4066



x12

3804-3



x3

3804-4



x3

3996



x12

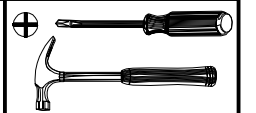

136239



x12

x3

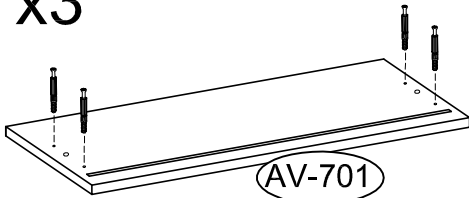

AV-701



AV-914

AV-913

IN01157

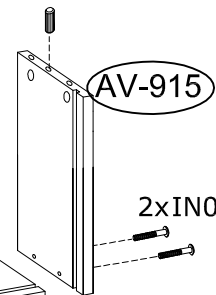

AV-915

2xIN01157

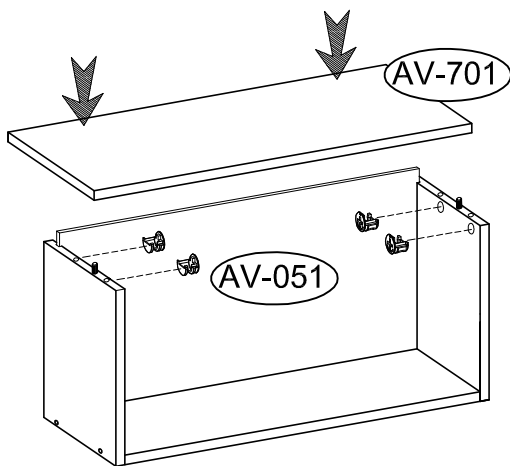

AV-701

AV-051

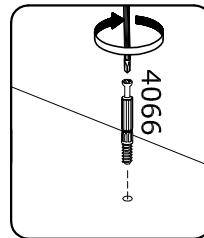

4066

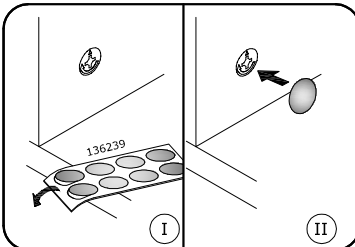
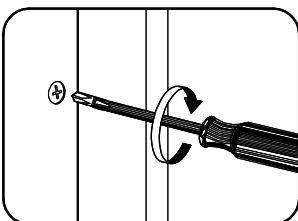
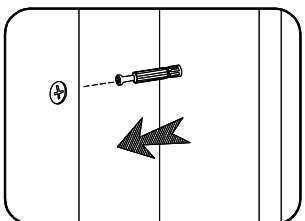
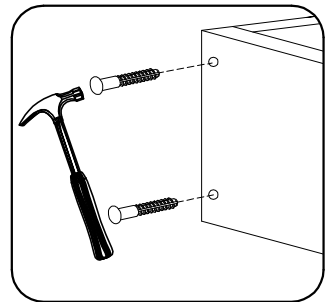

I

II

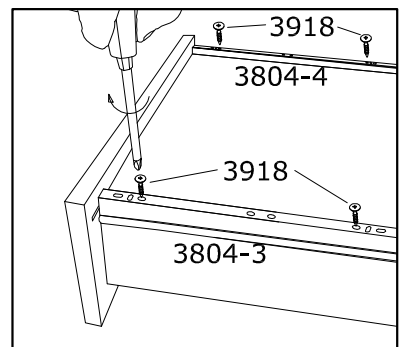
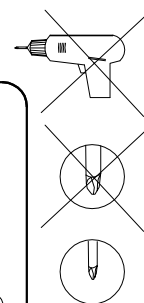

3918

3804-4

3918

3804-3

9

136858



x4

3879



x8

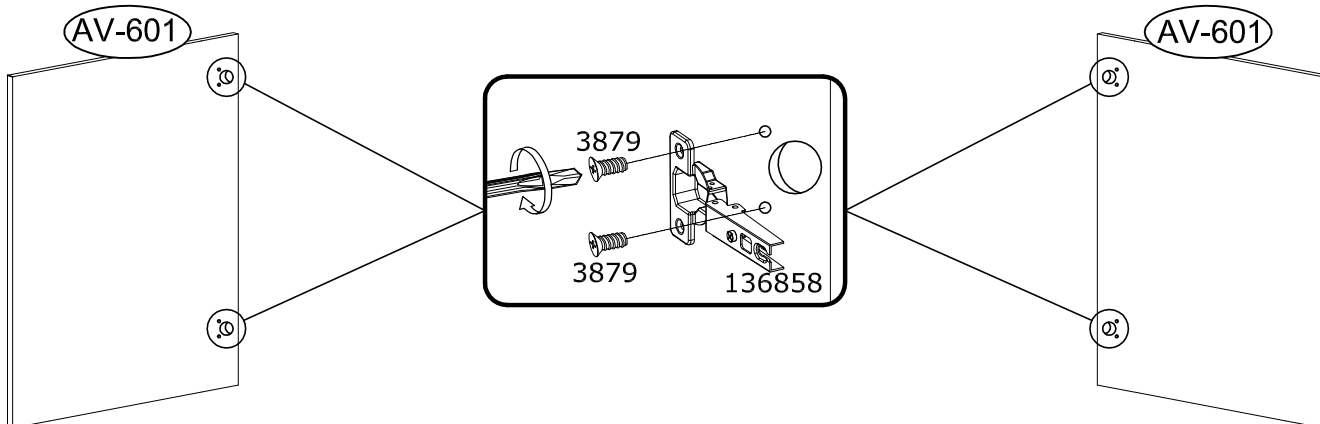

10

4066



x12

3996



x4

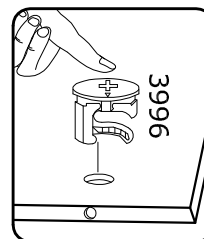
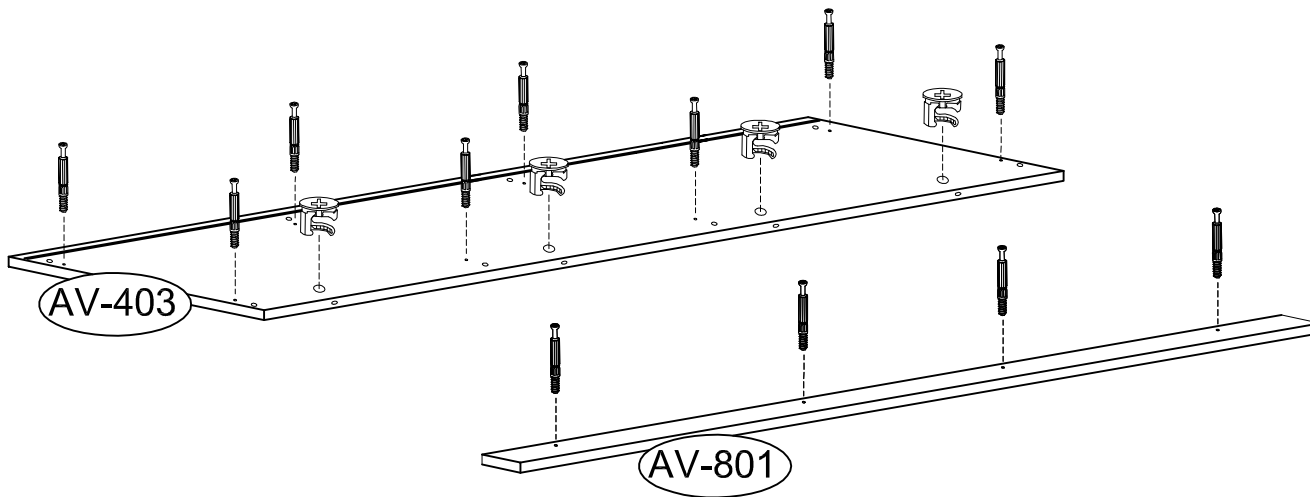

3996

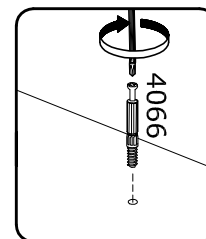

4066

11

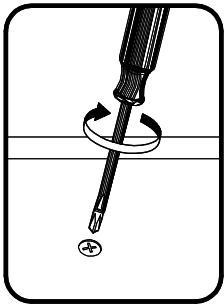
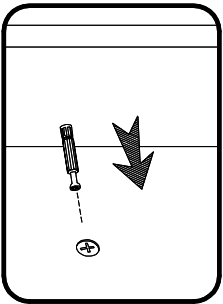
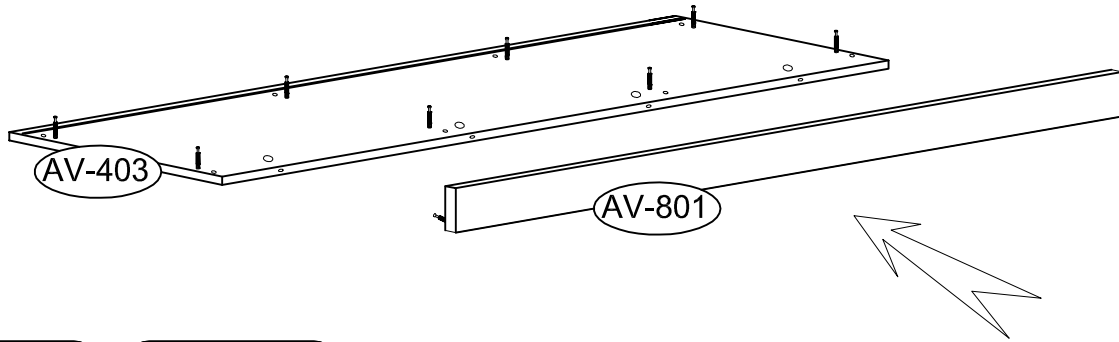

12

136239

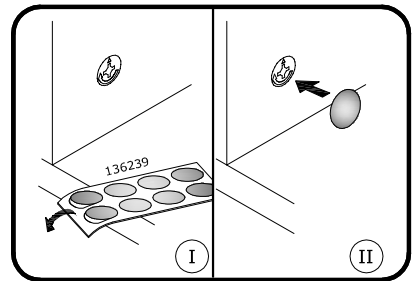
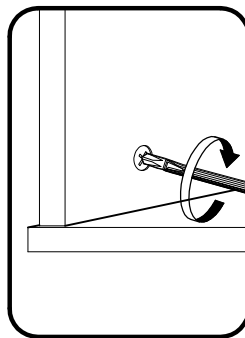
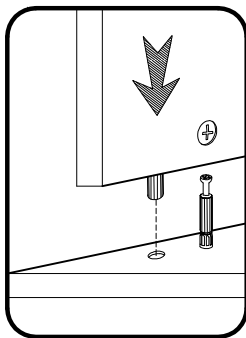
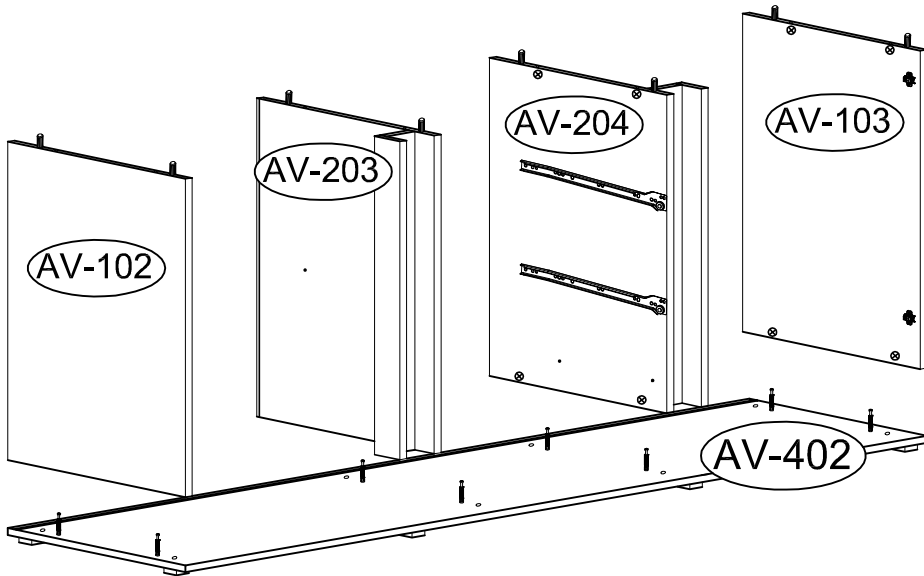

13

136239



x4

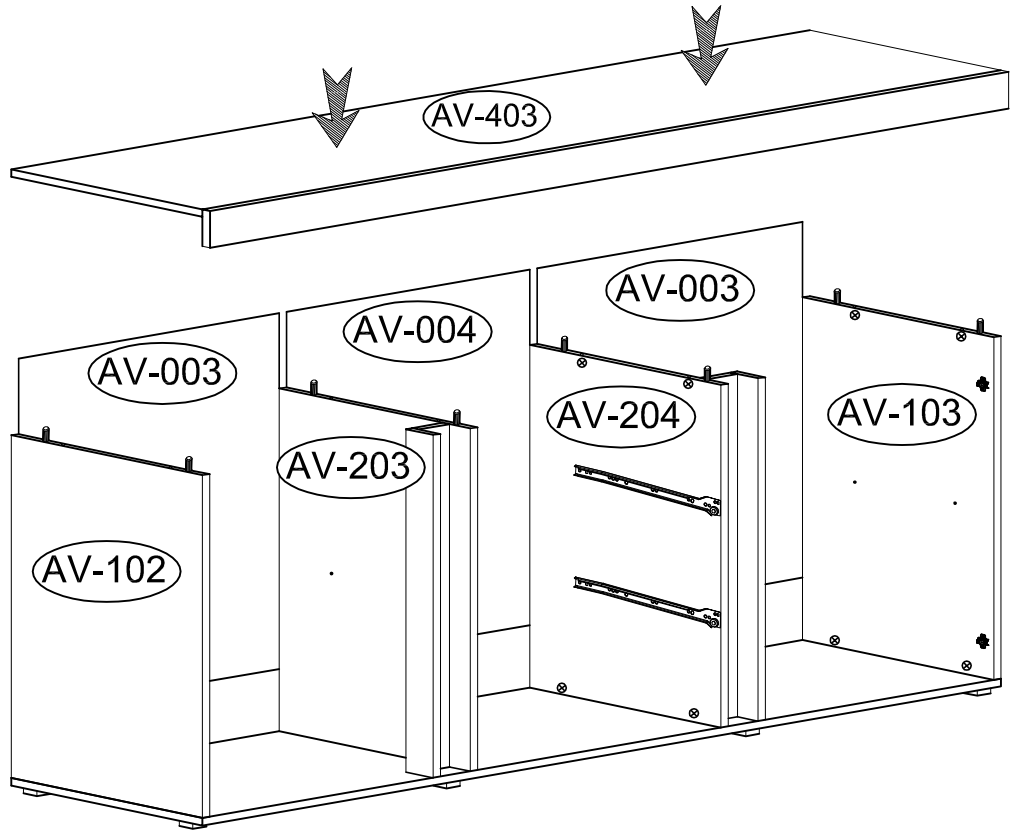
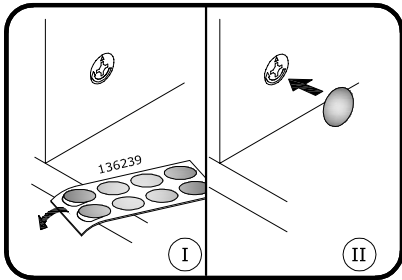
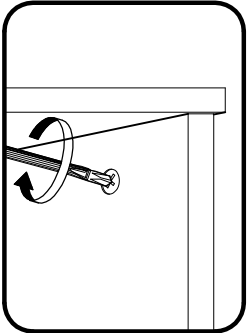
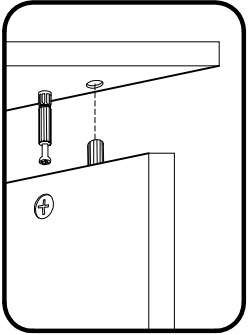

14

4044



x18

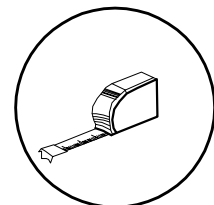
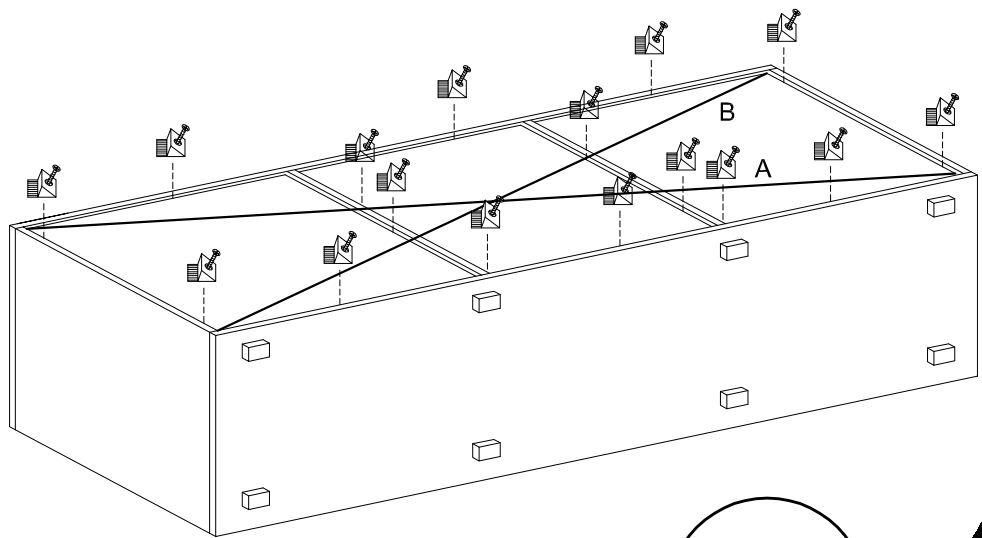
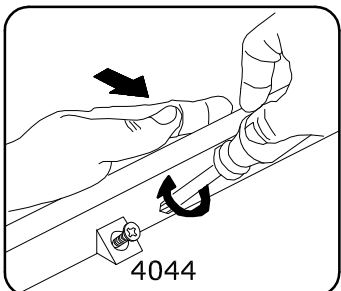
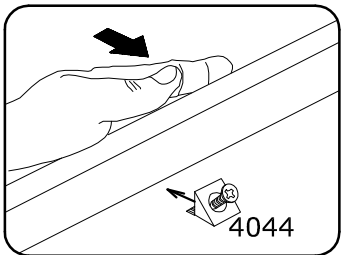

15

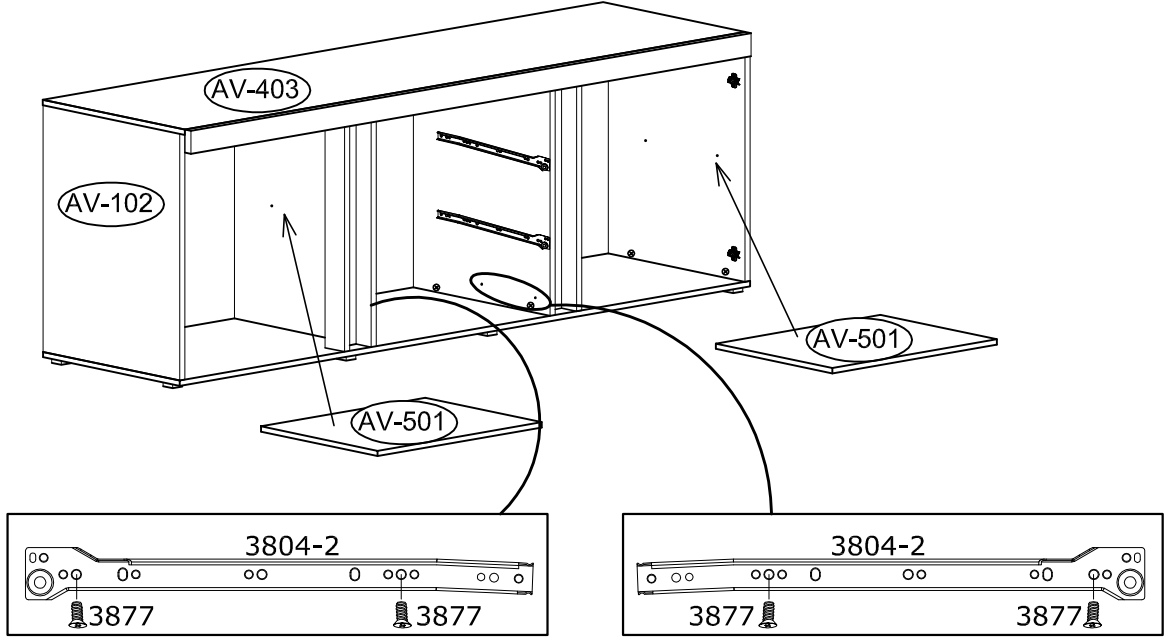
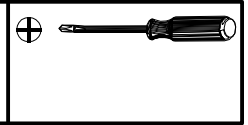
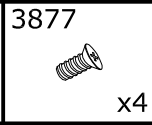
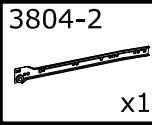
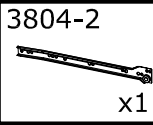

16

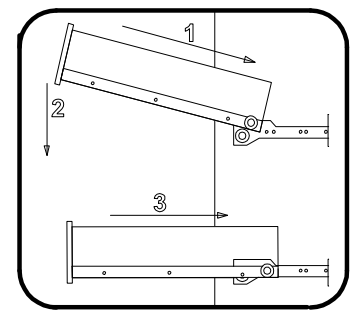
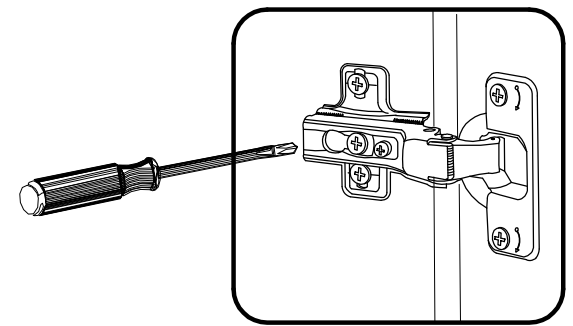
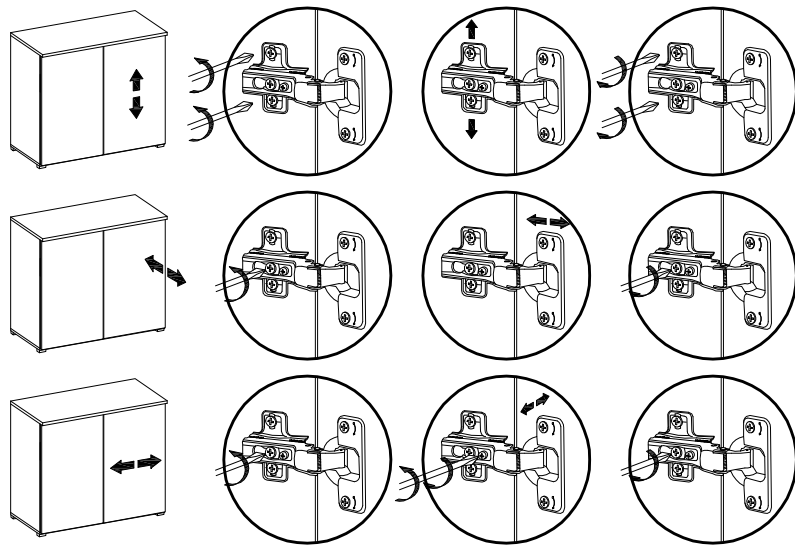
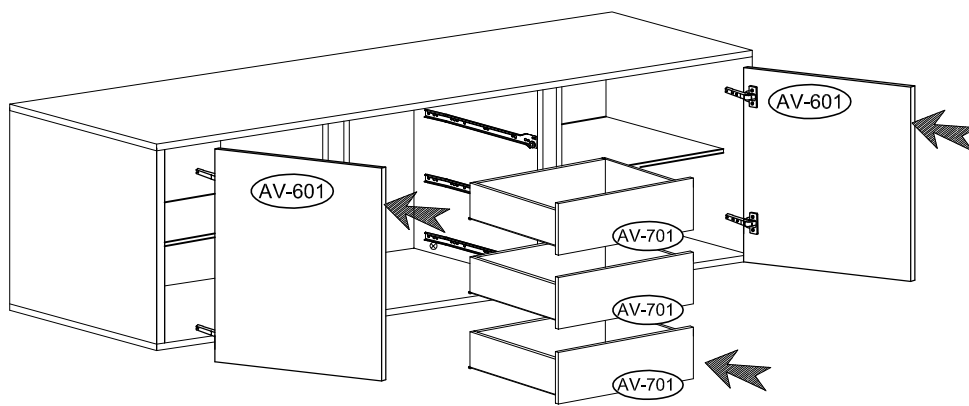
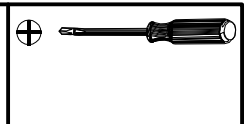

3918



x4

71900



x2

