

E-1	2029	395	16	x1	1/1
E-2	2029	395	16	x1	1/1
E-3	352	394	16	x1	1/1
E-4	352	394	16	x1	1/1
E-5	352	347	16	x1	1/1
E-6	352	347	16	x1	1/1
E-7	352	347	16	x1	1/1
E-8	482	335	16	x1	1/1
E-9	496	346	18	x2	1/1
E-10	496	346	16	x1	1/1
E-11	2010	366	3	x1	1/1

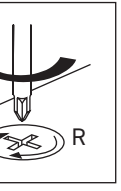

1

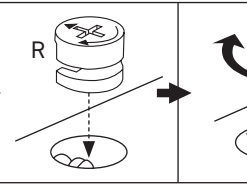
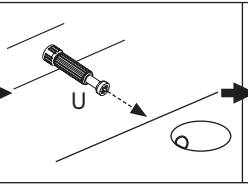
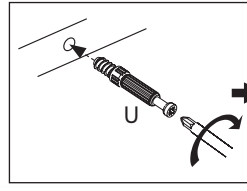
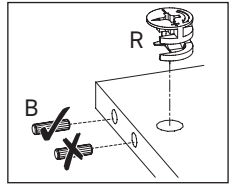
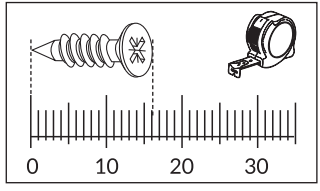
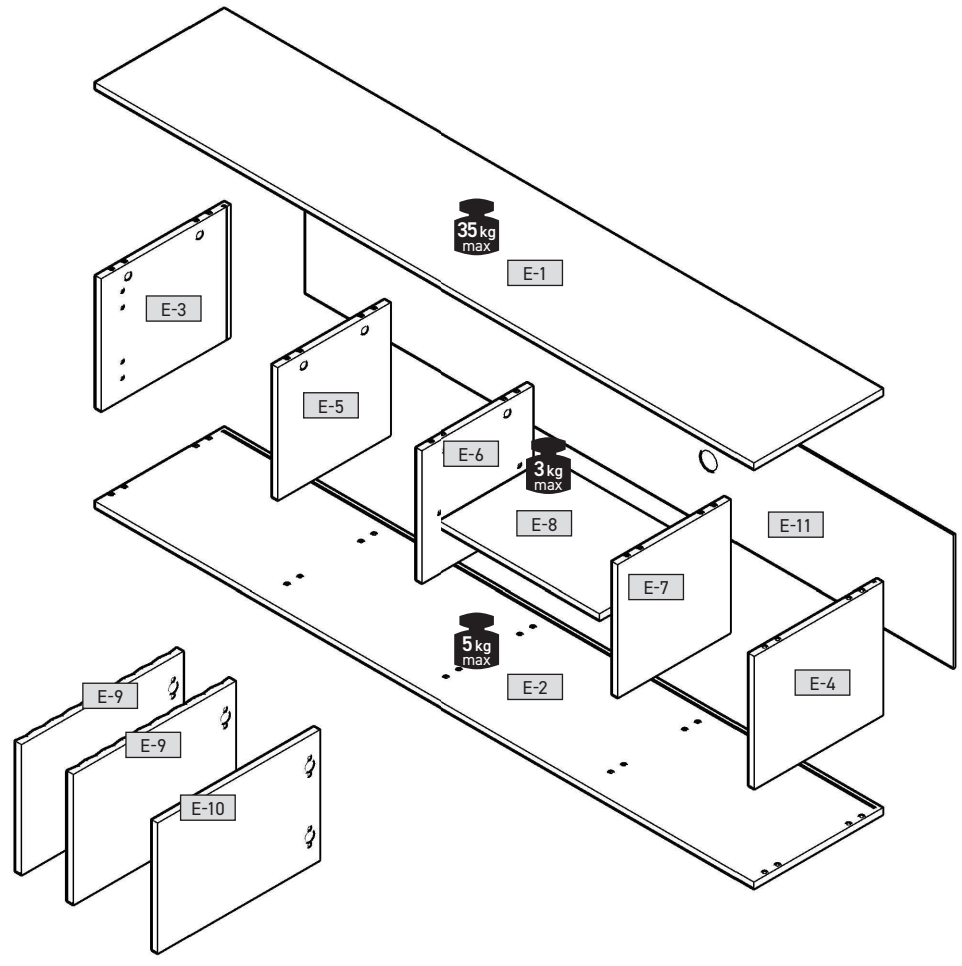
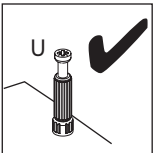
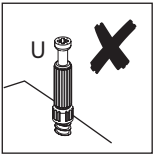
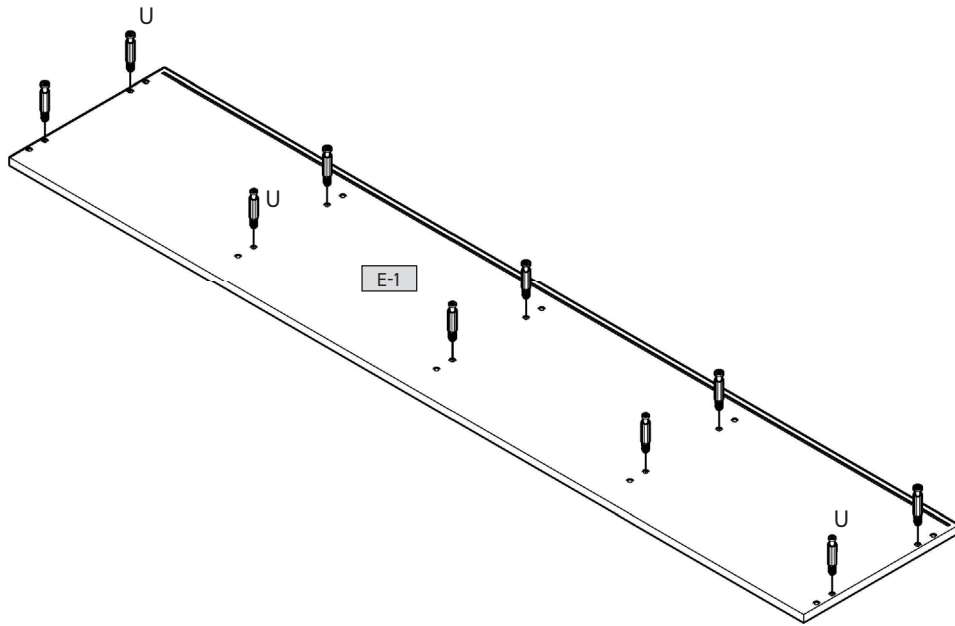
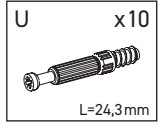

2

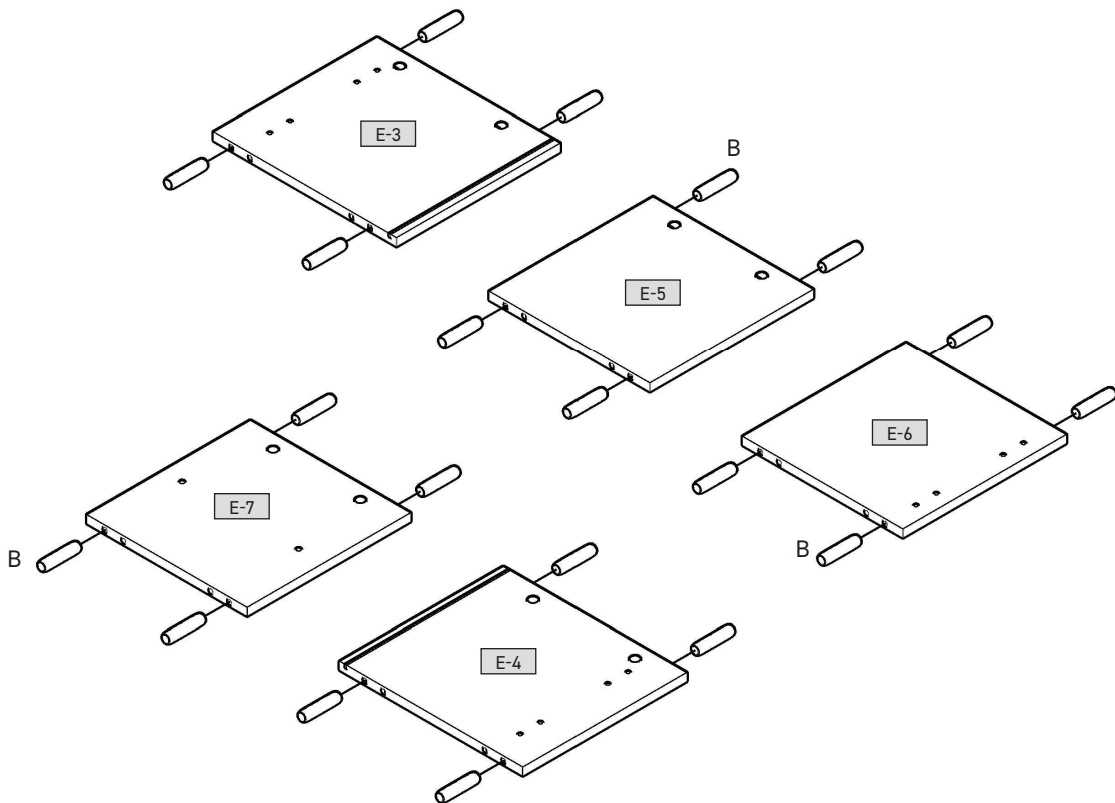
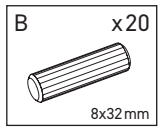

3

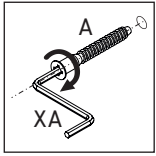
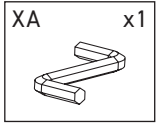
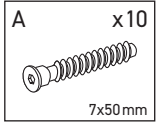
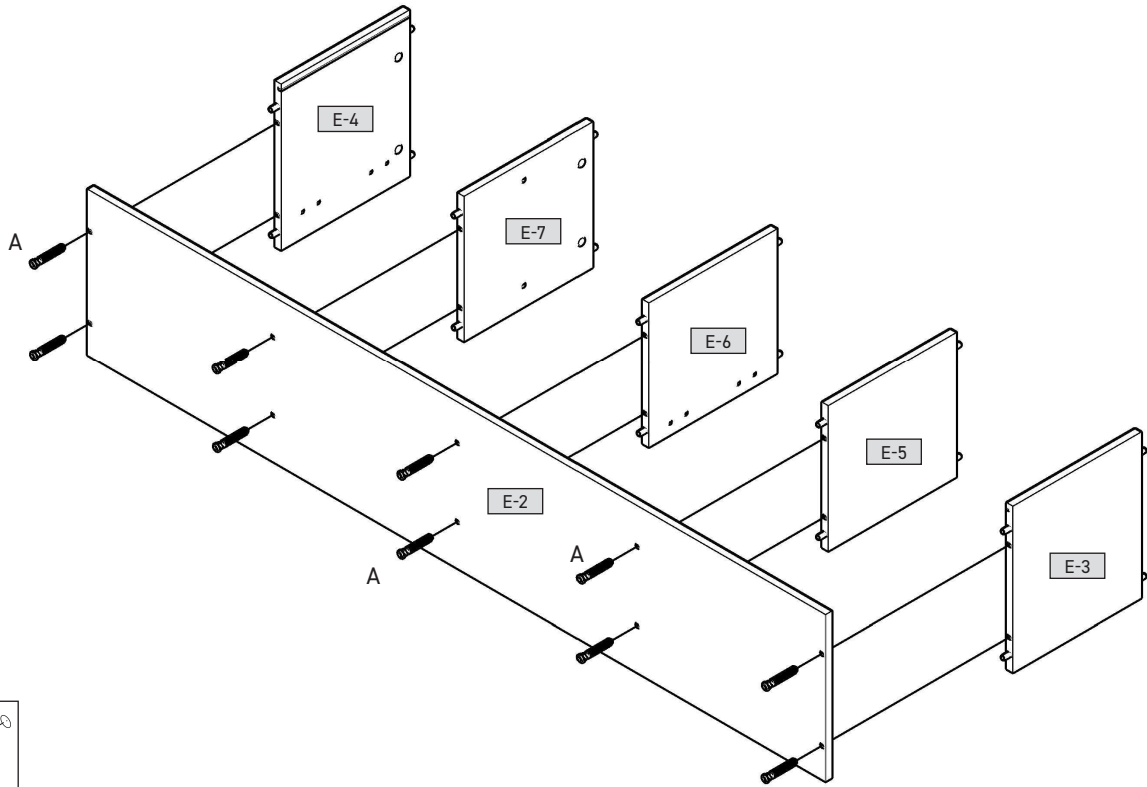

4

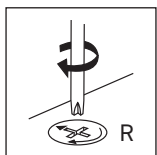
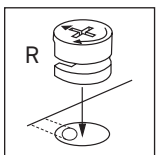
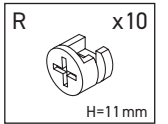
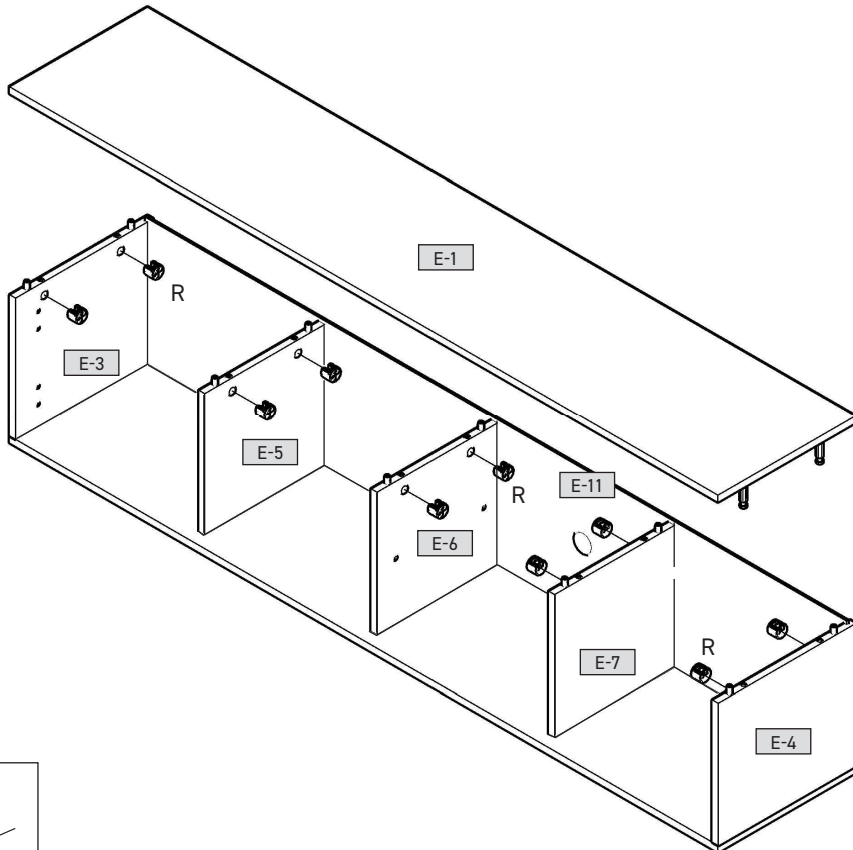

5

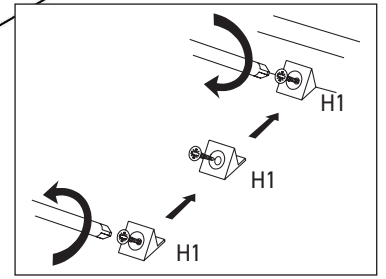
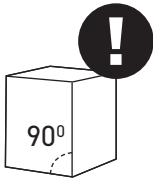
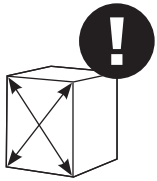
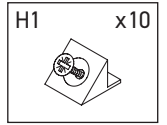
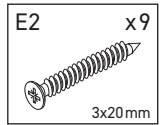
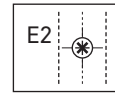
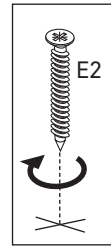
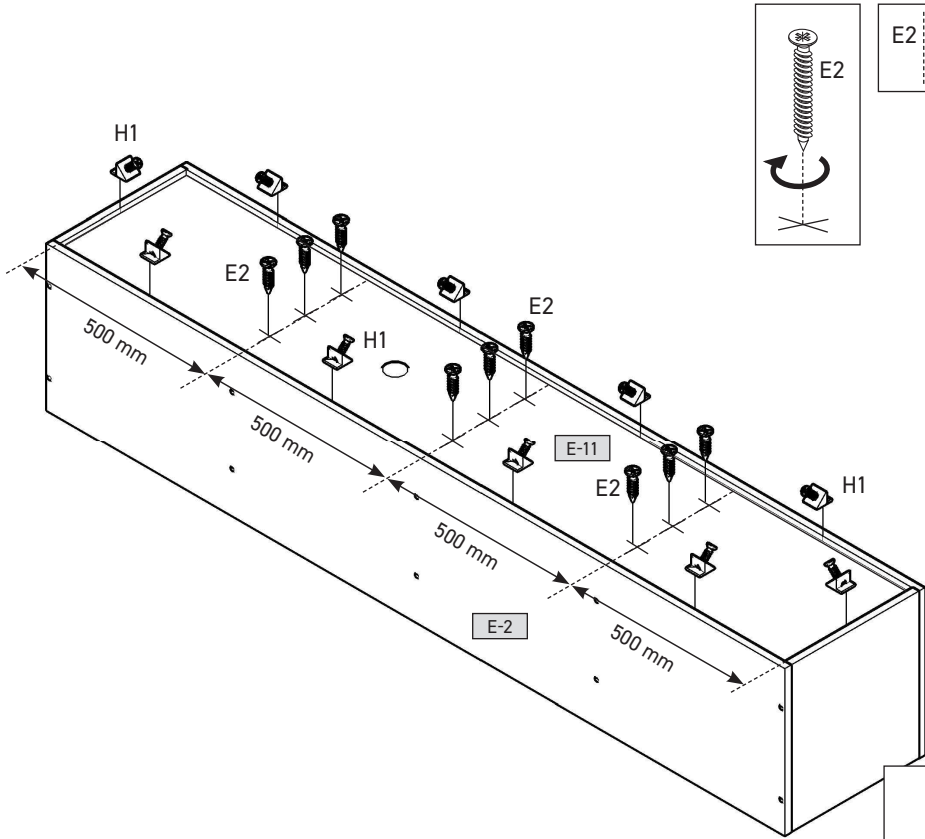
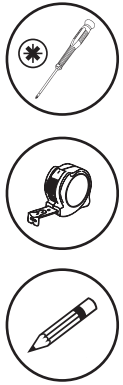

6

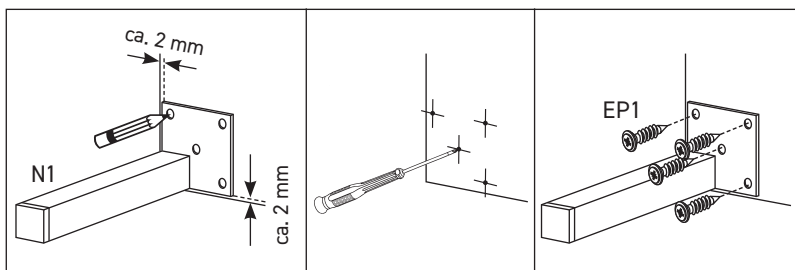
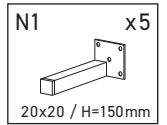
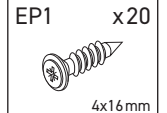
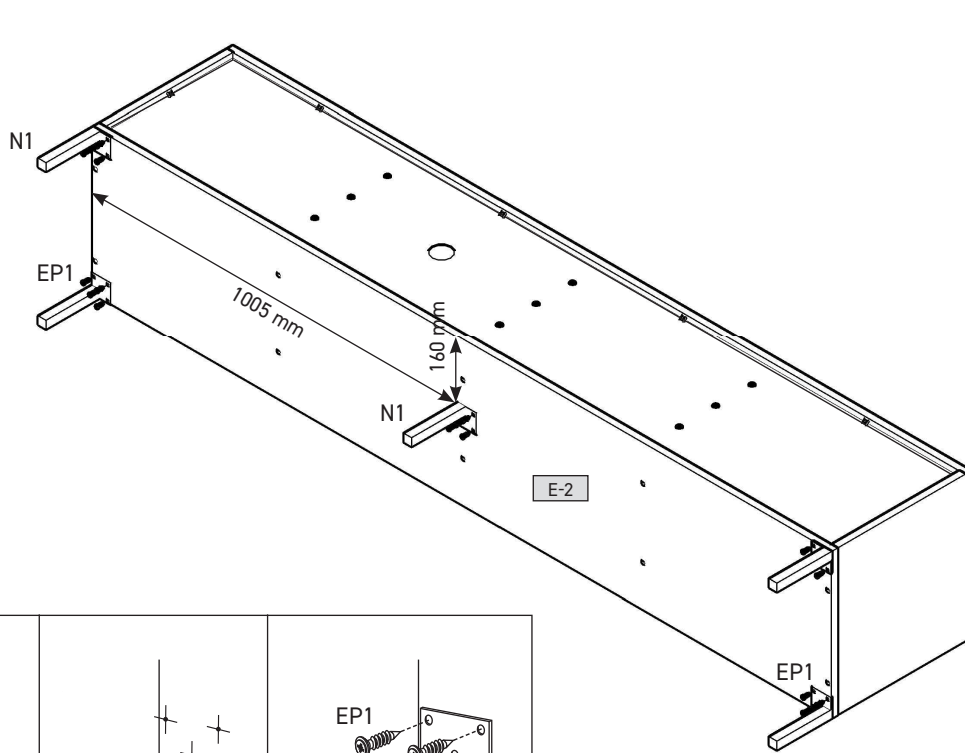

7

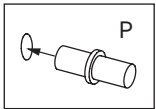
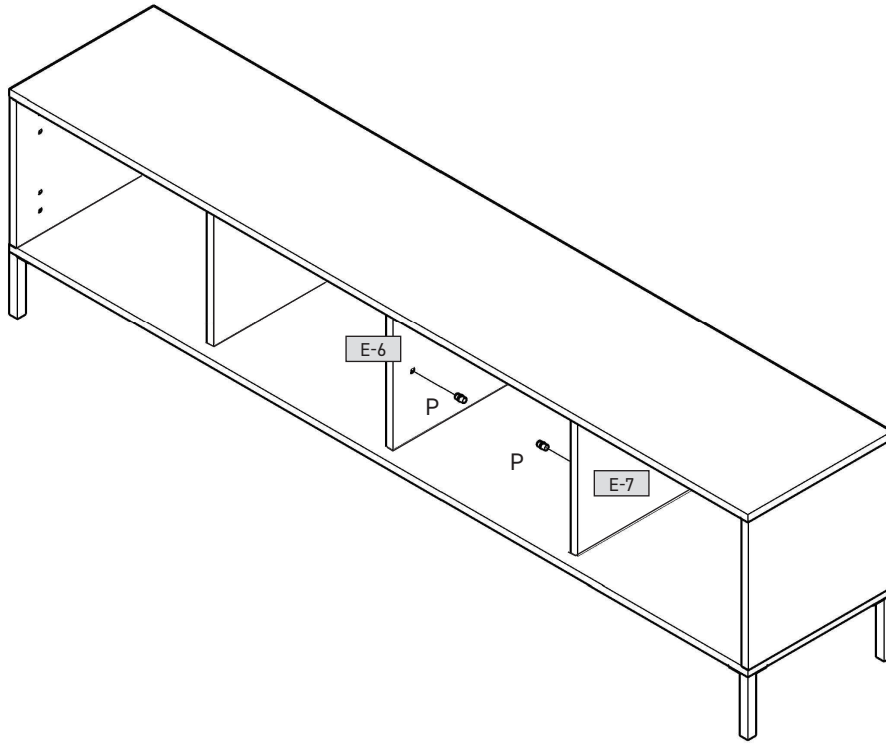
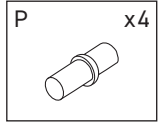
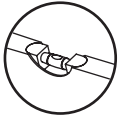

8

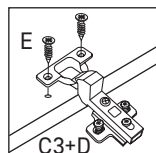
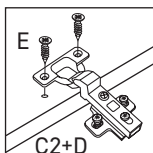
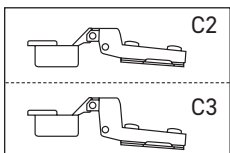
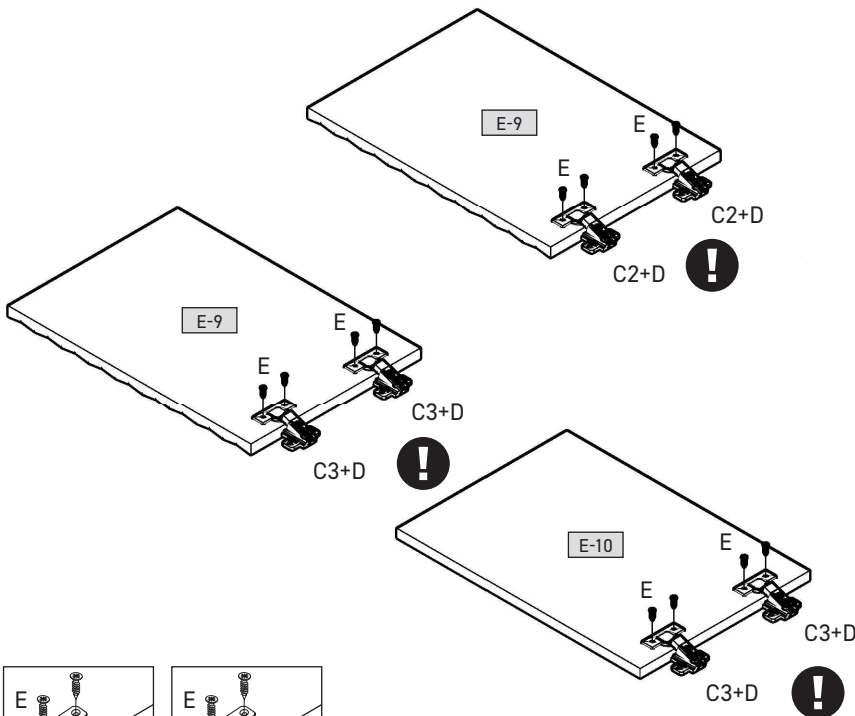
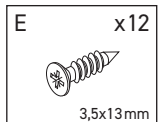
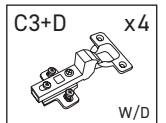
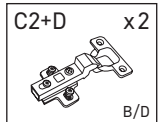

9

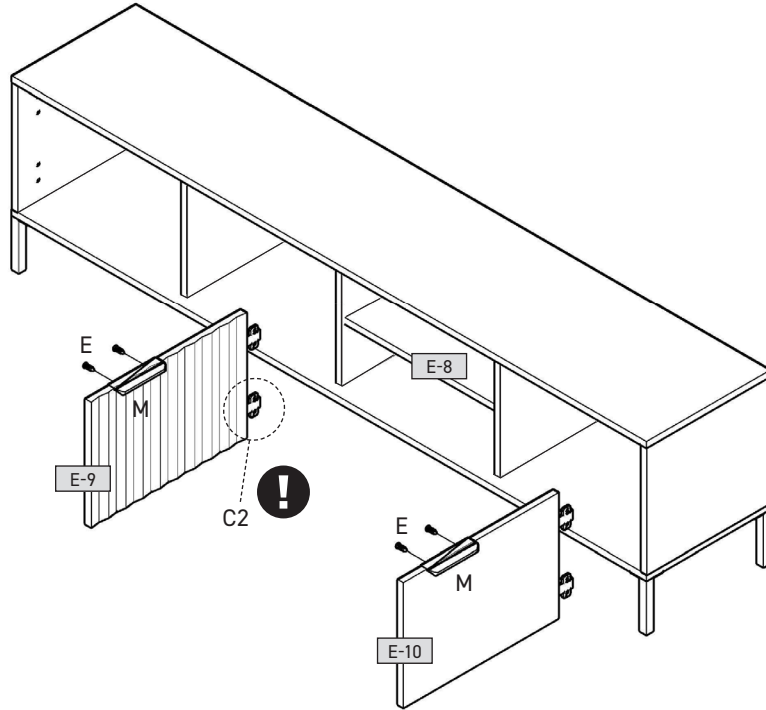
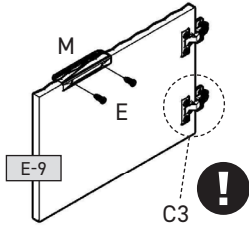
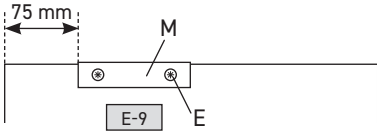

- E x6
3,5x13mm
- M x3
L=150mm
- ZA x10
ø4
- ZR x10
ø15

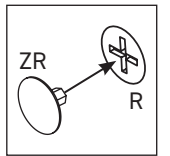
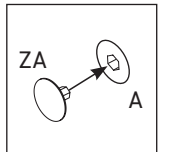
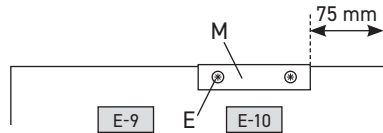
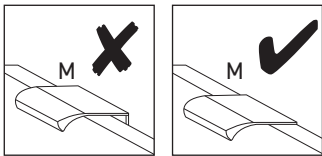
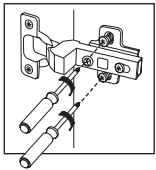

10

