

2022-07-29

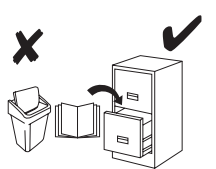

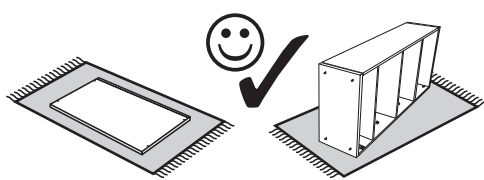

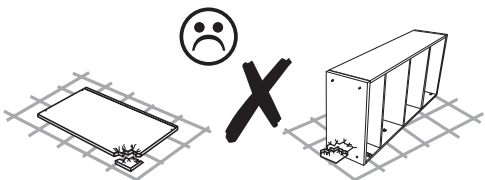
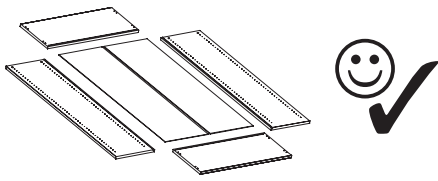
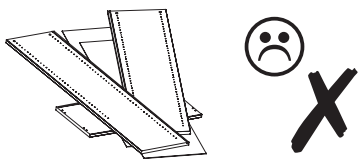
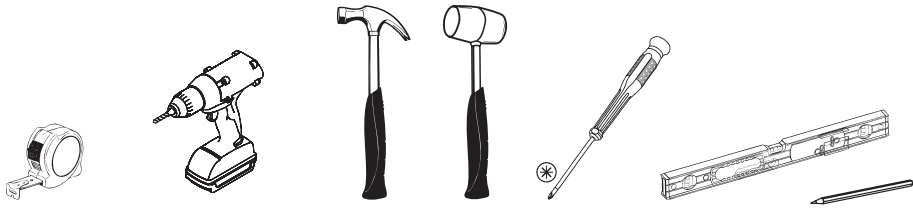
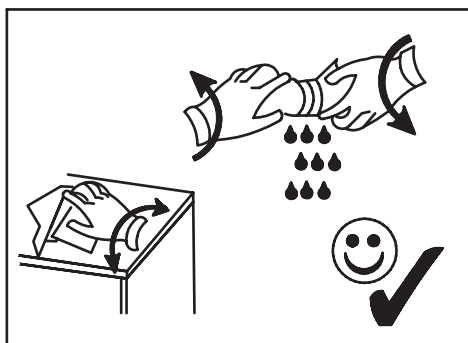
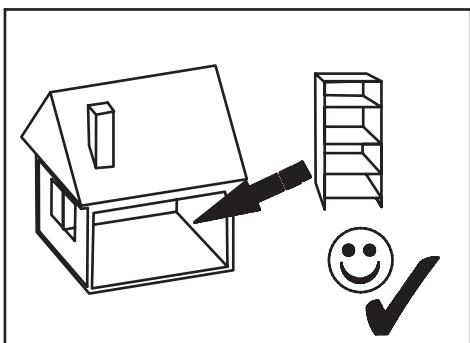
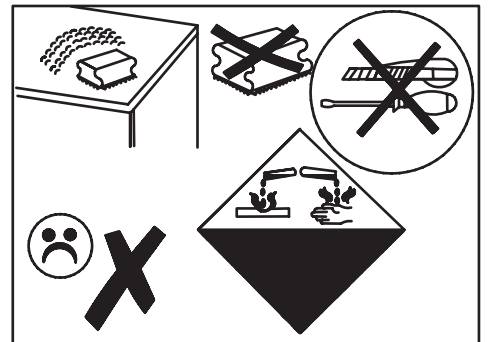
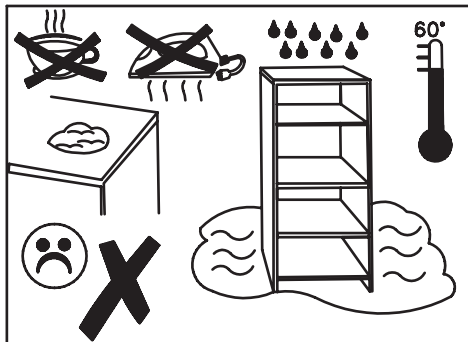
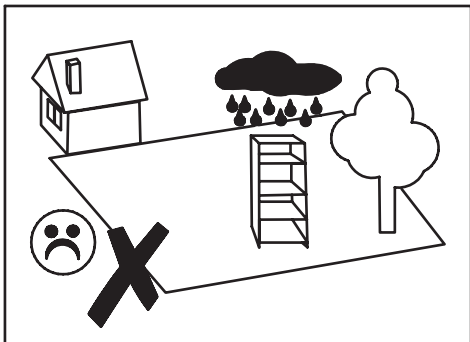
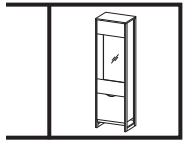
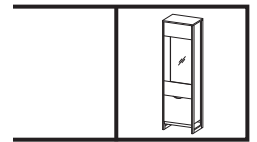

A 7 x 50 mm x 4	B 8 x 32 mm x 20	B3 8 x 50 mm x 4	C (P/D) x 4	E 3,5 x 13 mm x 9	E2 3 x 20 mm x 8	G2 x 4	H1 x 11	HDF 802 / 100 mm x 1
P x 16	R H=11 mm x 12	T4 6,3 x 24 mm x 24	U L=24,3 mm x 12	W1 x 1	XA x 1	XG x 2	ZR Ø15 x 12	

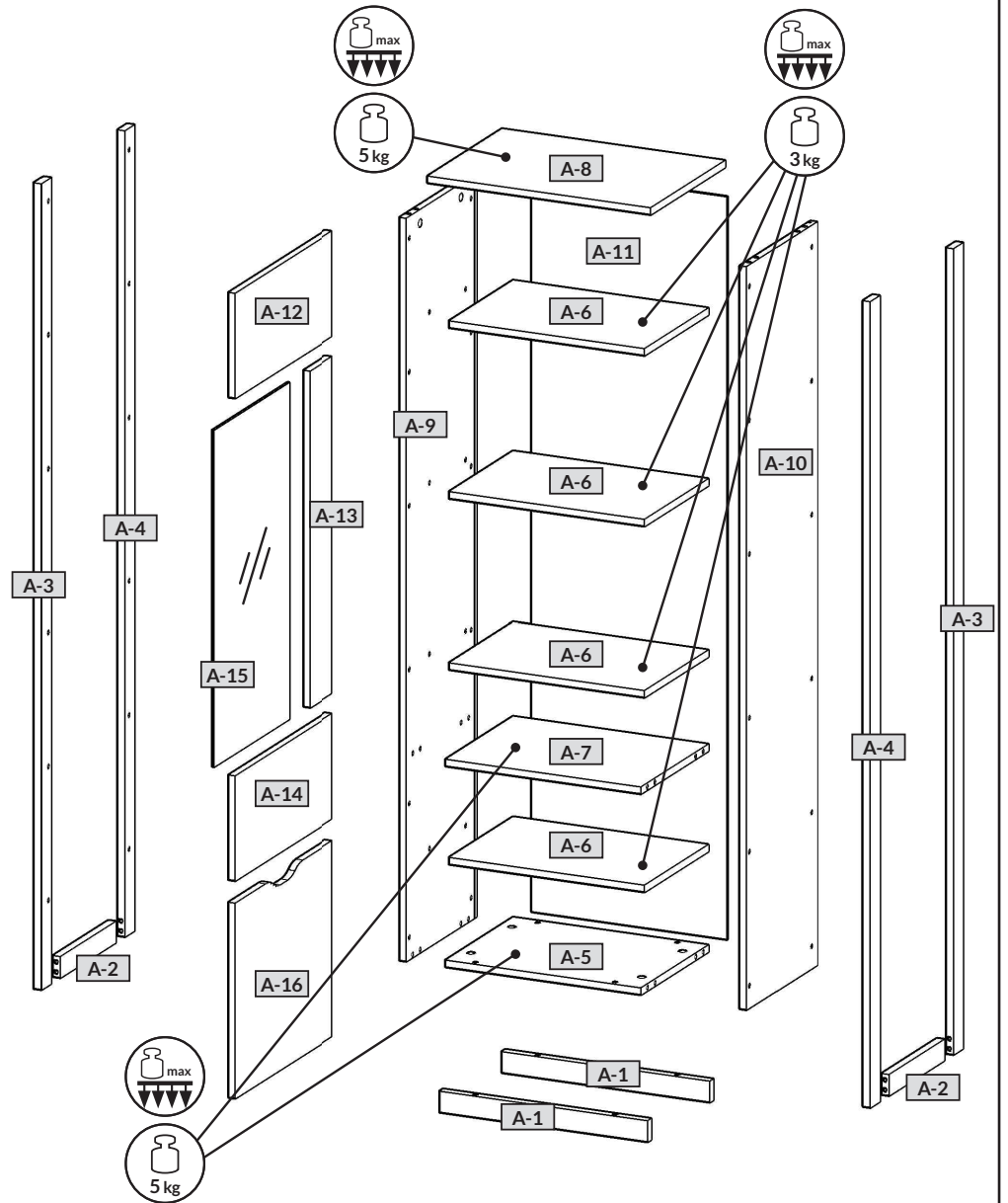

nr	↔ [mm]	↓ [mm]	∅ [mm]	Colli
A-1	524	50	15 x 2	1/1
A-2	294	50	15 x 2	1/1
A-3	1924	50	15 x 2	1/1
A-4	1924	50	15 x 2	1/1
A-5	492	359	16 x 1	1/1
A-6	492	340	16 x 4	1/1
A-7	492	359	16 x 1	1/1
A-8	562	396	16 x 1	1/1
A-9	1774	374	16 x 1	1/1
A-10	1774	374	16 x 1	1/1
A-11	506	1782	3 x 1	1/1
A-12	520	250	16 x 1	1/1
A-13	120	802	16 x 1	1/1
A-14	520	250	16 x 1	1/1
A-15	415	834	4 x 1	1/1
A-16	520	466	16 x 1	1/1

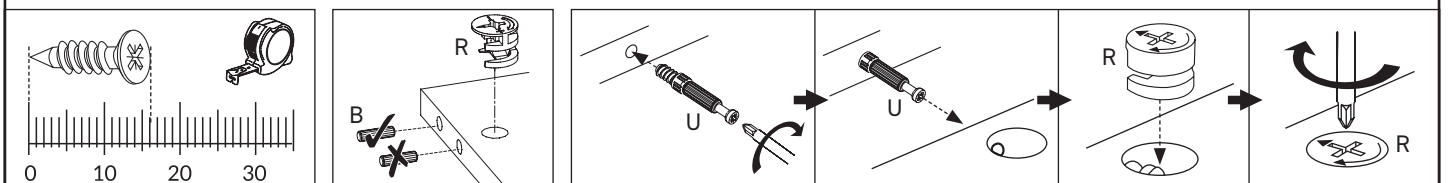



1

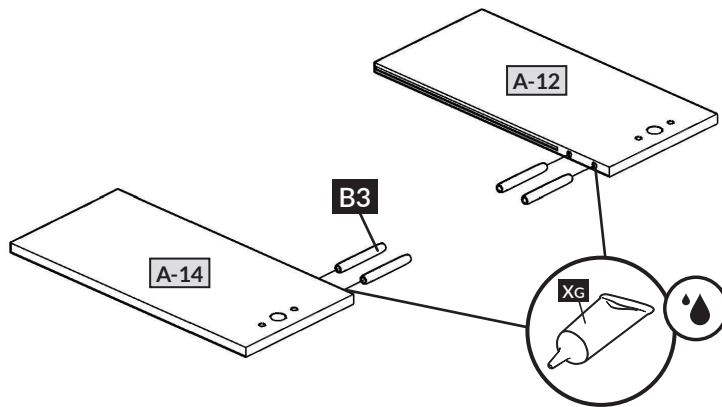

B3
8 x 50 mm x 4

XG
x 1

2

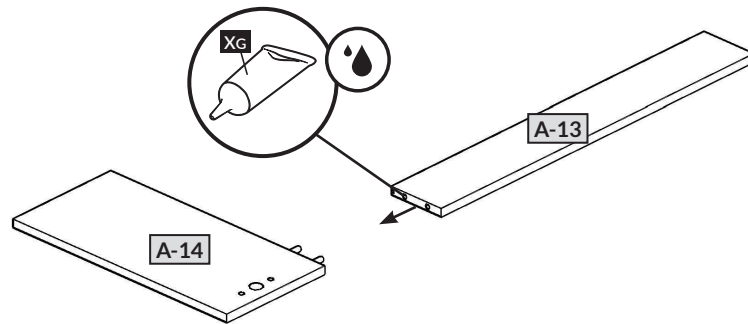

XG
x 1

3

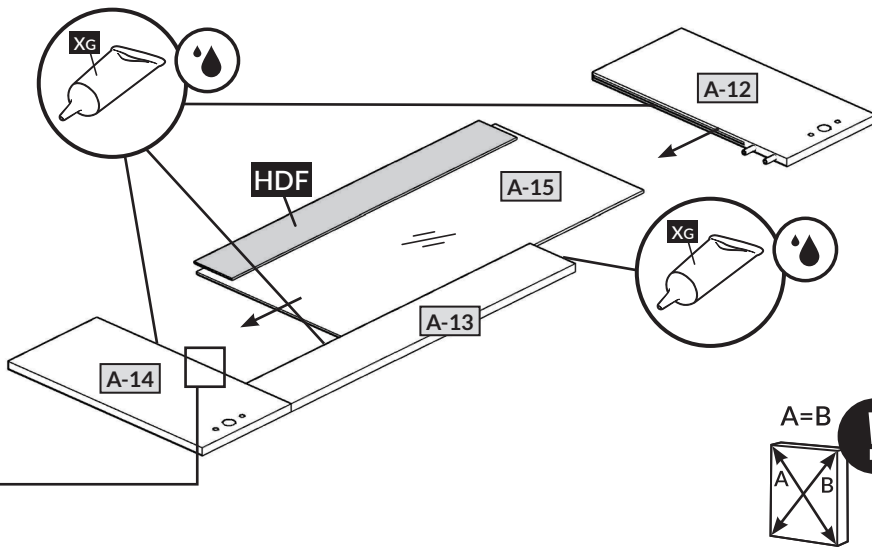

HDF
802 / 100 mm x 1

XG
x 1

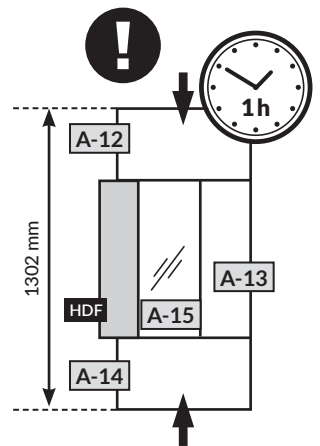

4

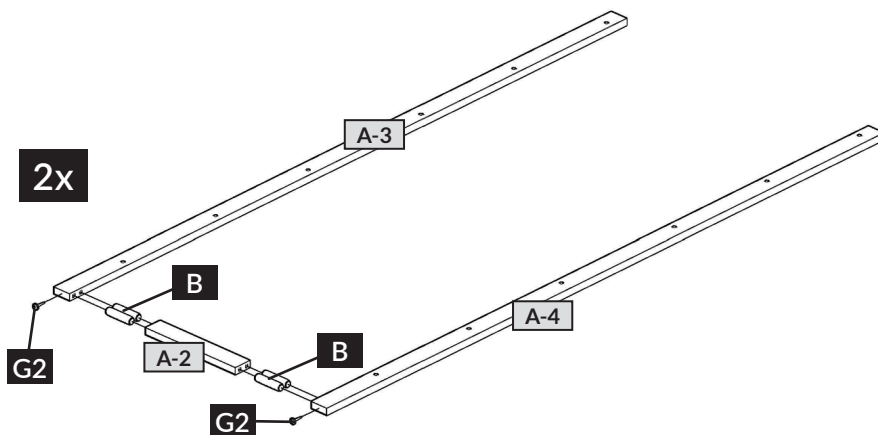

B
8 x 32 mm x 8

G2
x 4

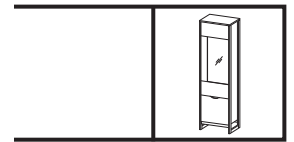

5

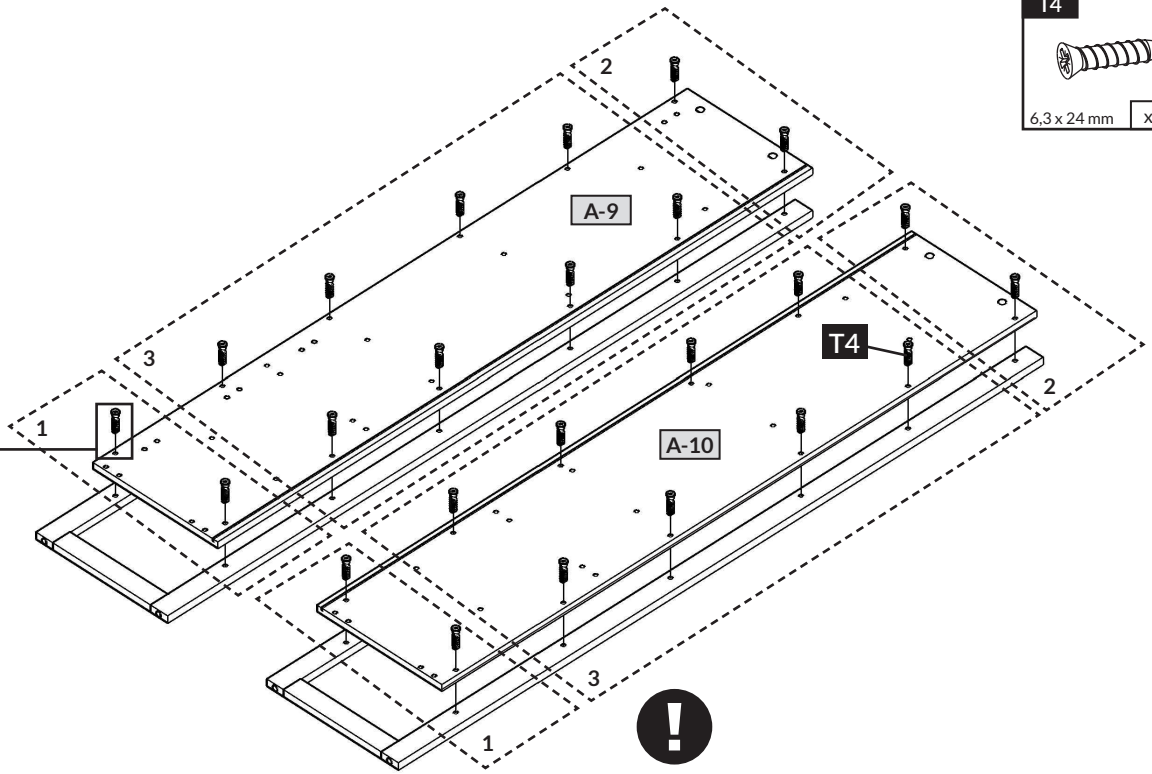
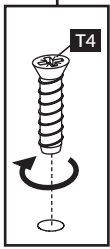

T4

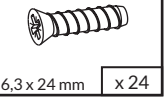

6

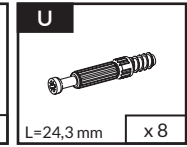
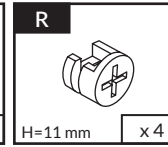
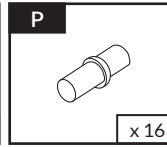
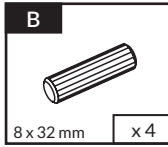
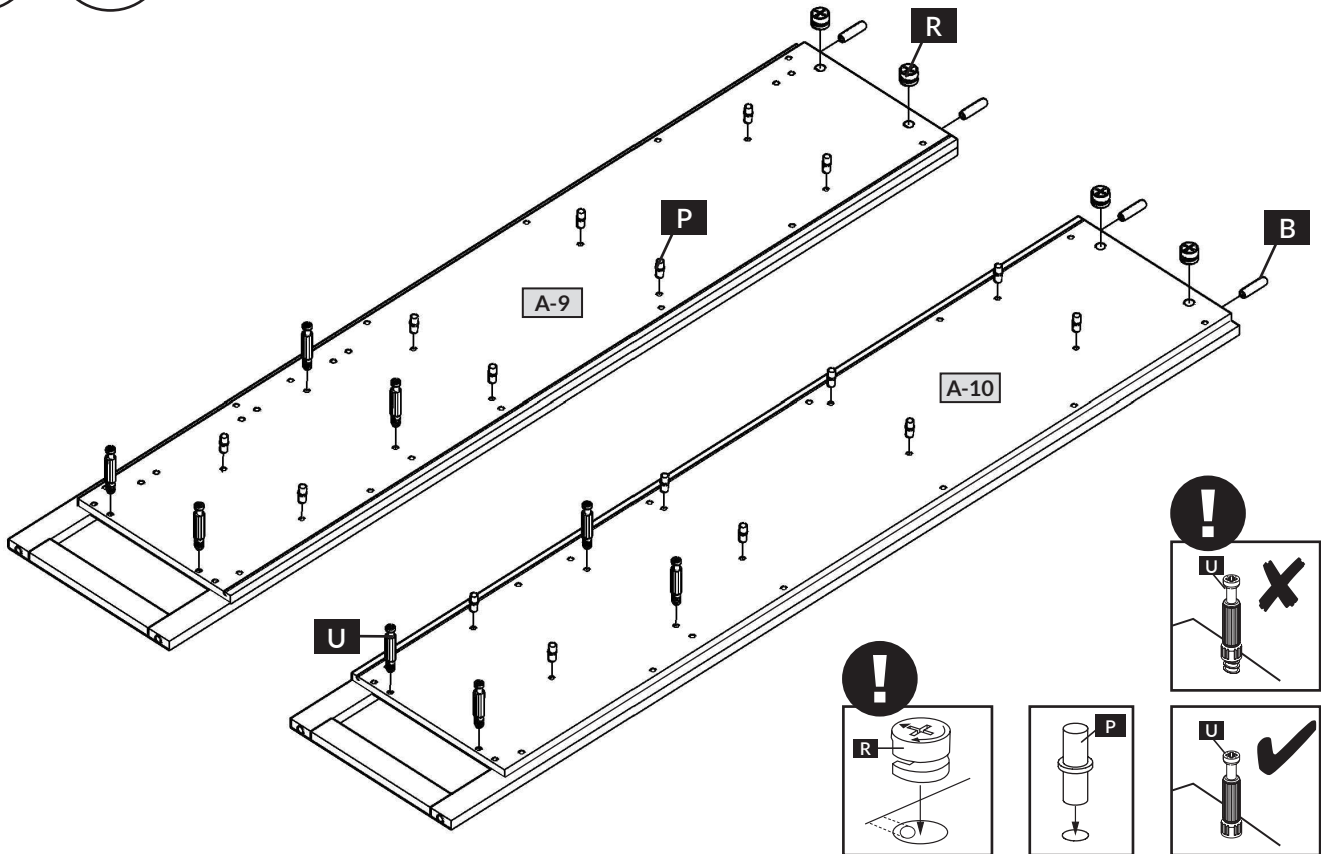

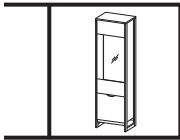

7

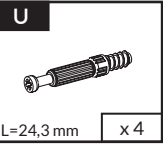
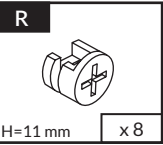
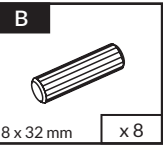
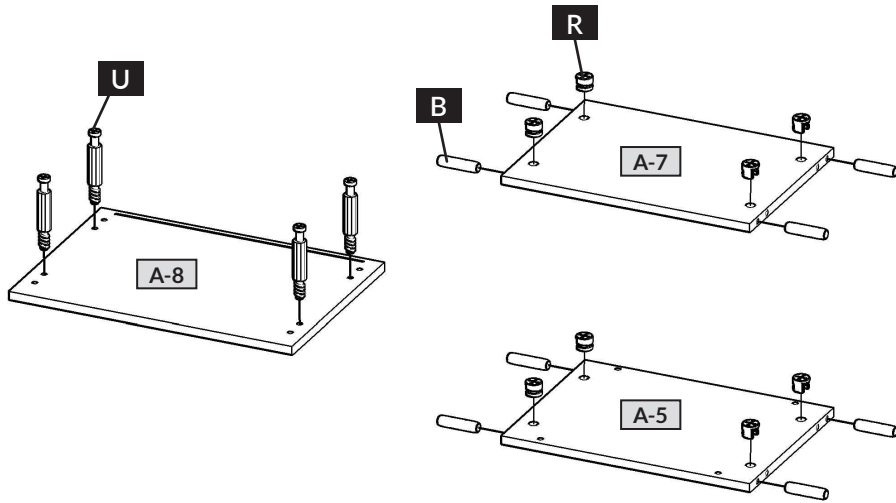
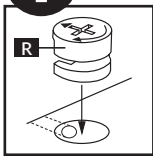

8

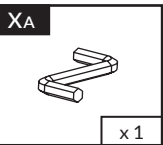
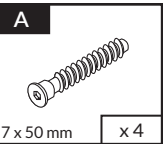
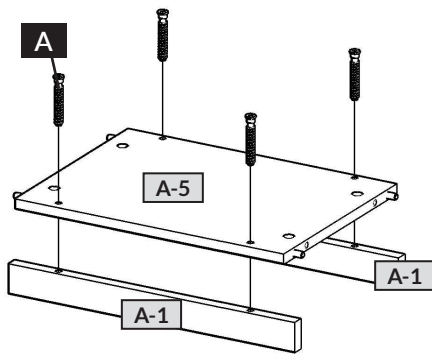
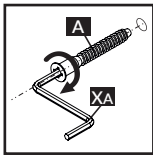

9

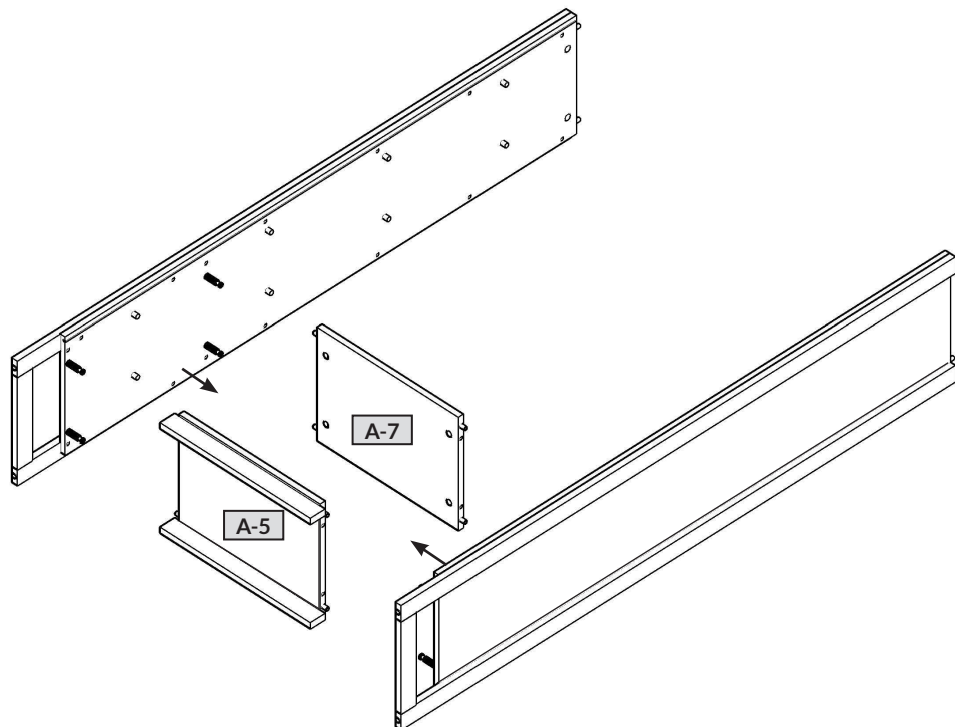
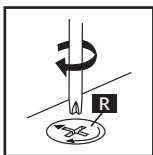

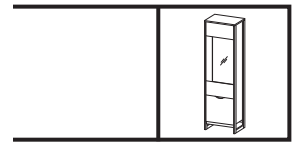

10

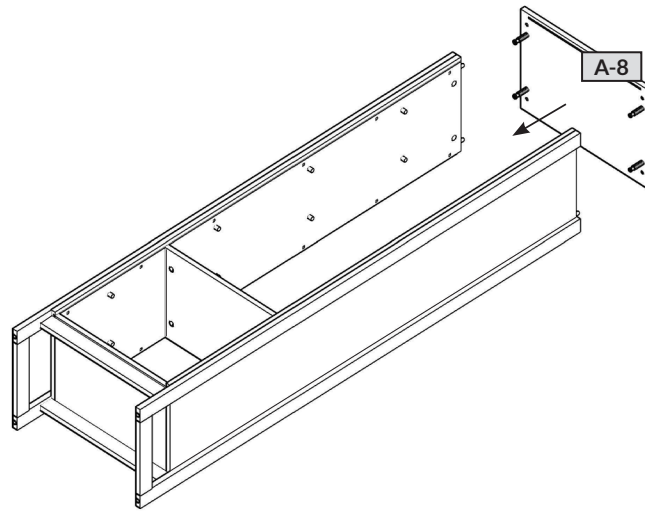

11

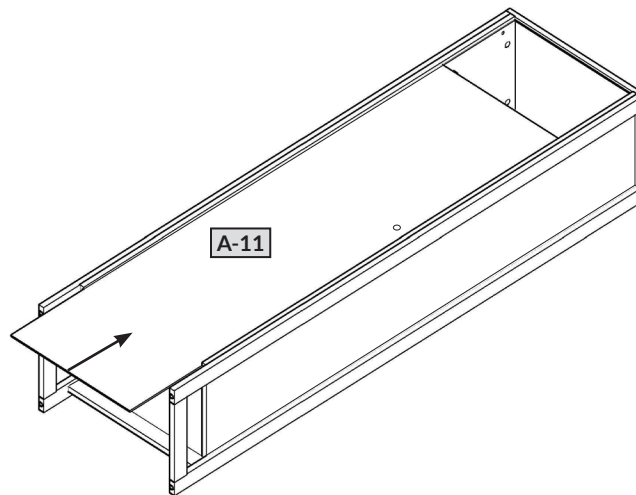

12

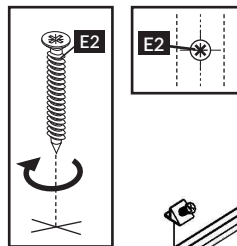

H1

A-11

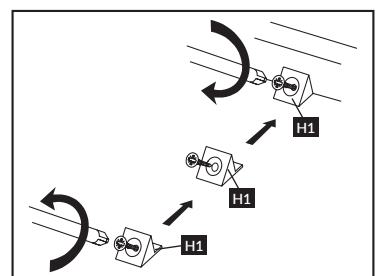
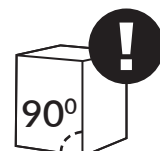
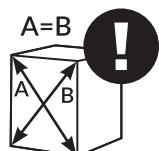
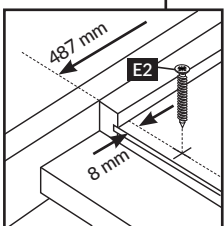
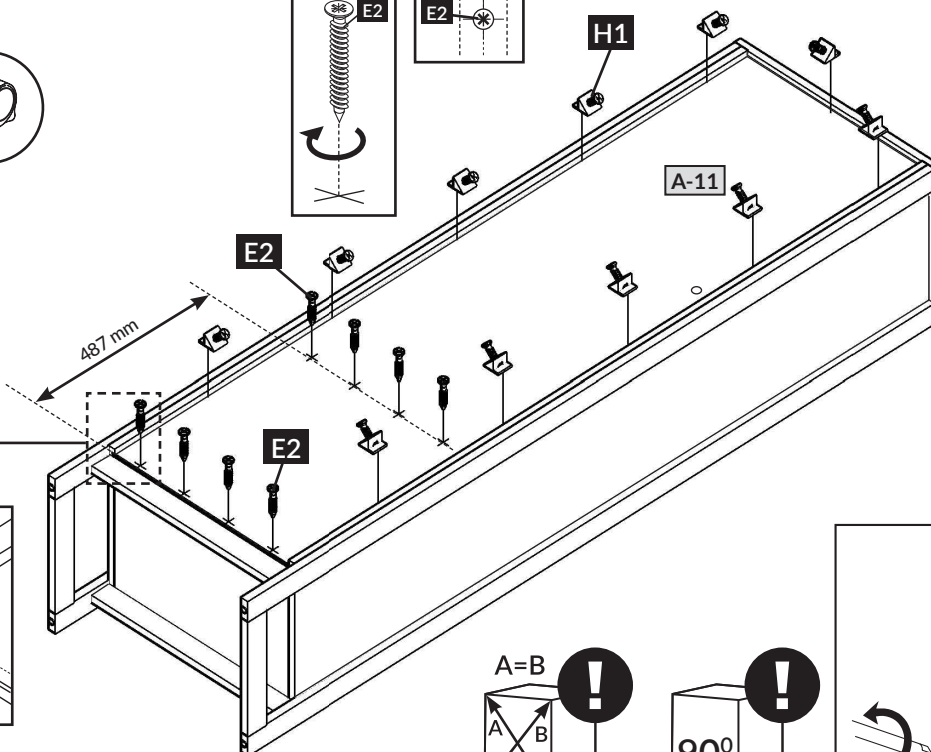
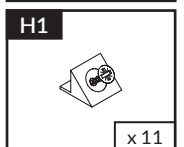
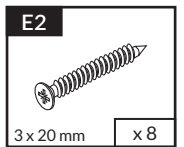

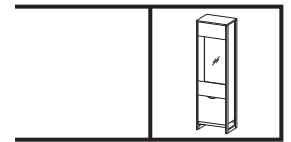

13

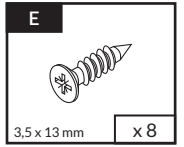
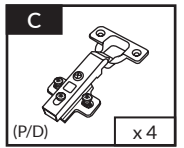
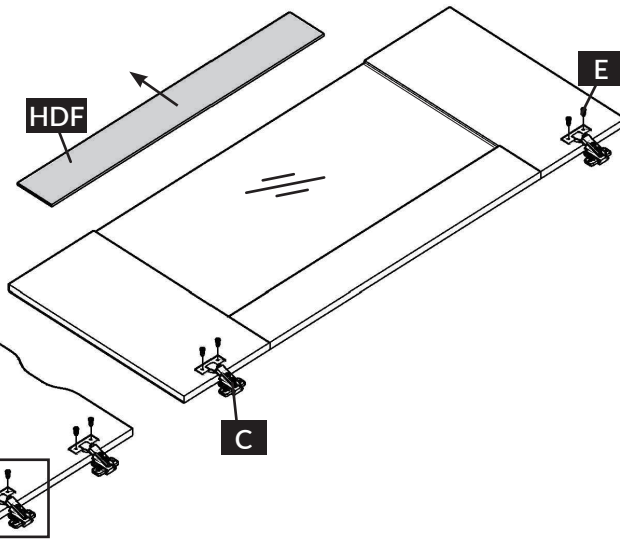
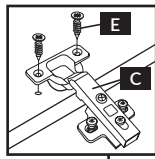

14

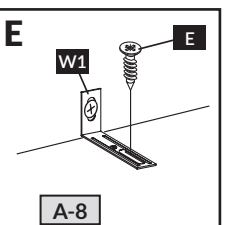
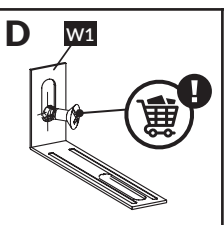
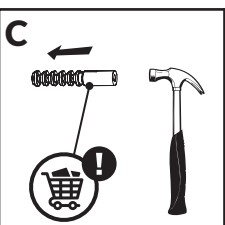
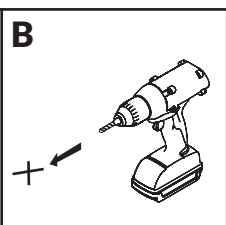
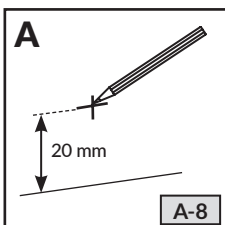
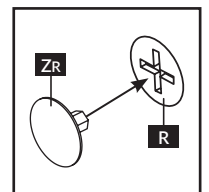
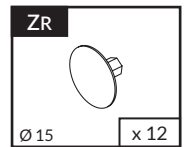
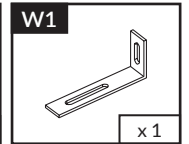
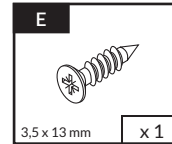
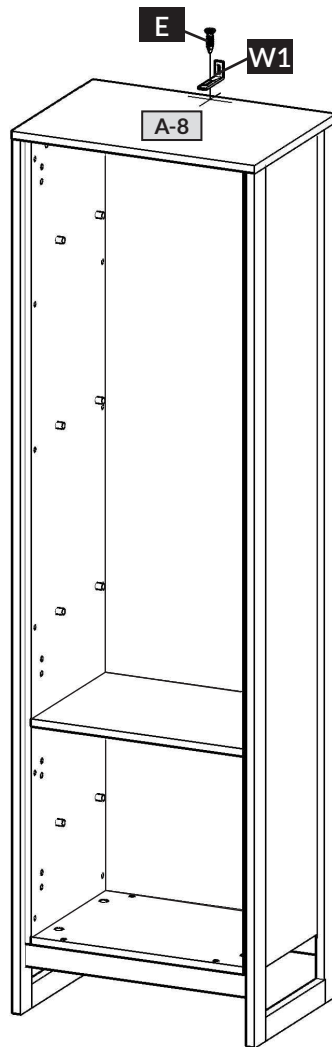
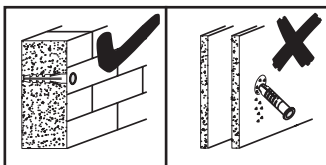
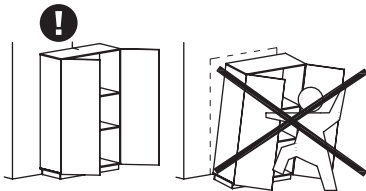
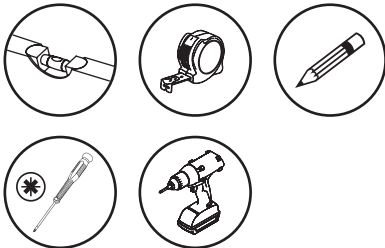

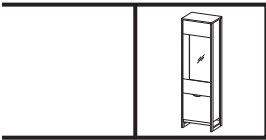

15

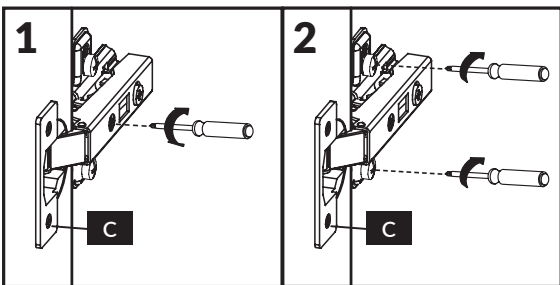

16

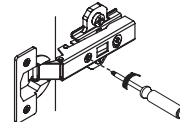
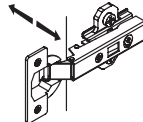
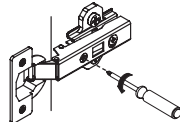
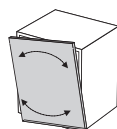
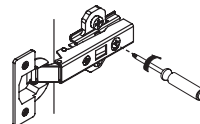
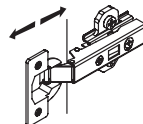
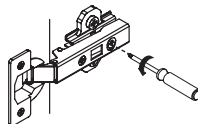
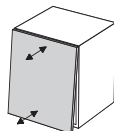
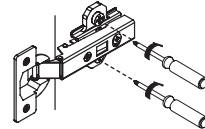
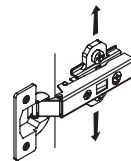
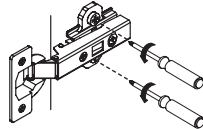
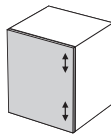
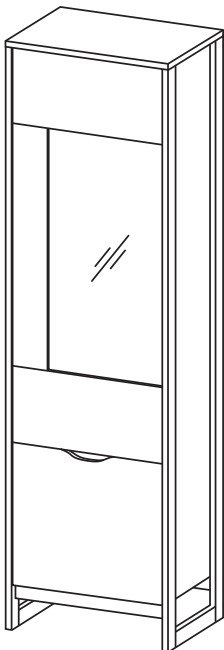

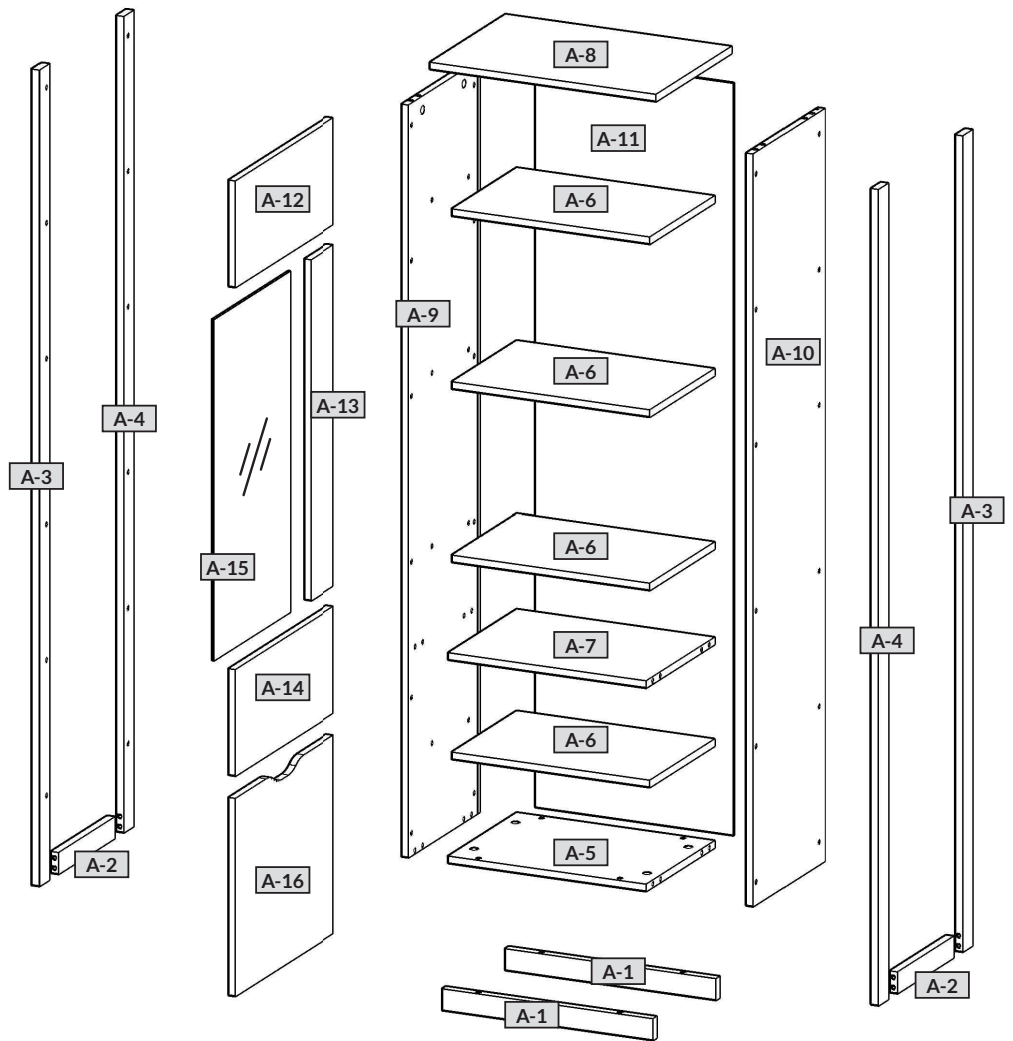
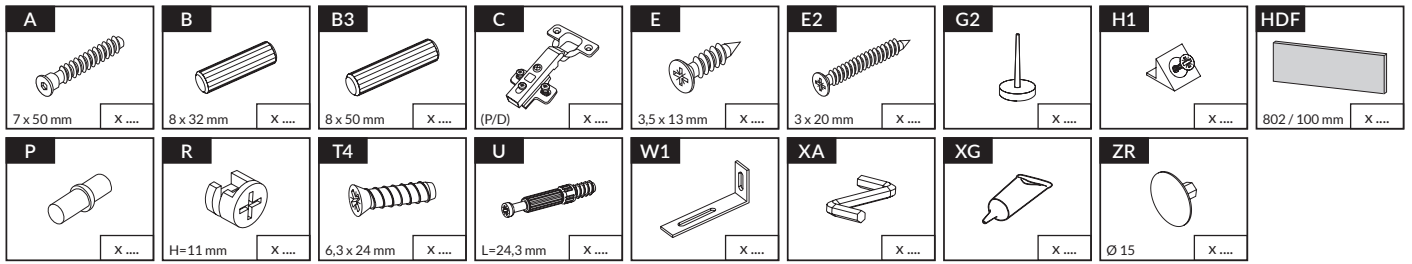
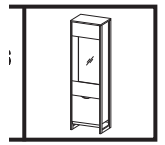

nr	↔ [mm]	↓ [mm]	∅ [mm]		Colli
A-1	524	50	15	x2	1/1
A-2	294	50	15	x2	1/1
A-3	1924	50	15	x2	1/1
A-4	1924	50	15	x2	1/1
A-5	492	359	16	x1	1/1
A-6	492	340	16	x4	1/1
A-7	492	359	16	x1	1/1
A-8	562	396	16	x1	1/1
A-9	1774	374	16	x1	1/1
A-10	1774	374	16	x1	1/1
A-11	506	1782	3	x1	1/1
A-12	520	250	16	x1	1/1
A-13	120	802	16	x1	1/1
A-14	520	250	16	x1	1/1
A-15	415	834	4	x1	1/1
A-16	520	466	16	x1	1/1

