

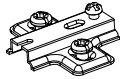
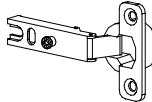
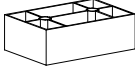

K

 6 x 13 x8

F

 x2

D

 x2

G

 x4

M

 4 x 25 x8

P

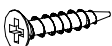
 x8

W

 x2

E

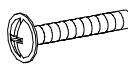
 3 x 20 x40

U

 x3

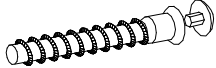
N

 M4 x 22 x6

H

 35cm x2

A

 x4

B

 x30

T

 4 x 16 x16

Z

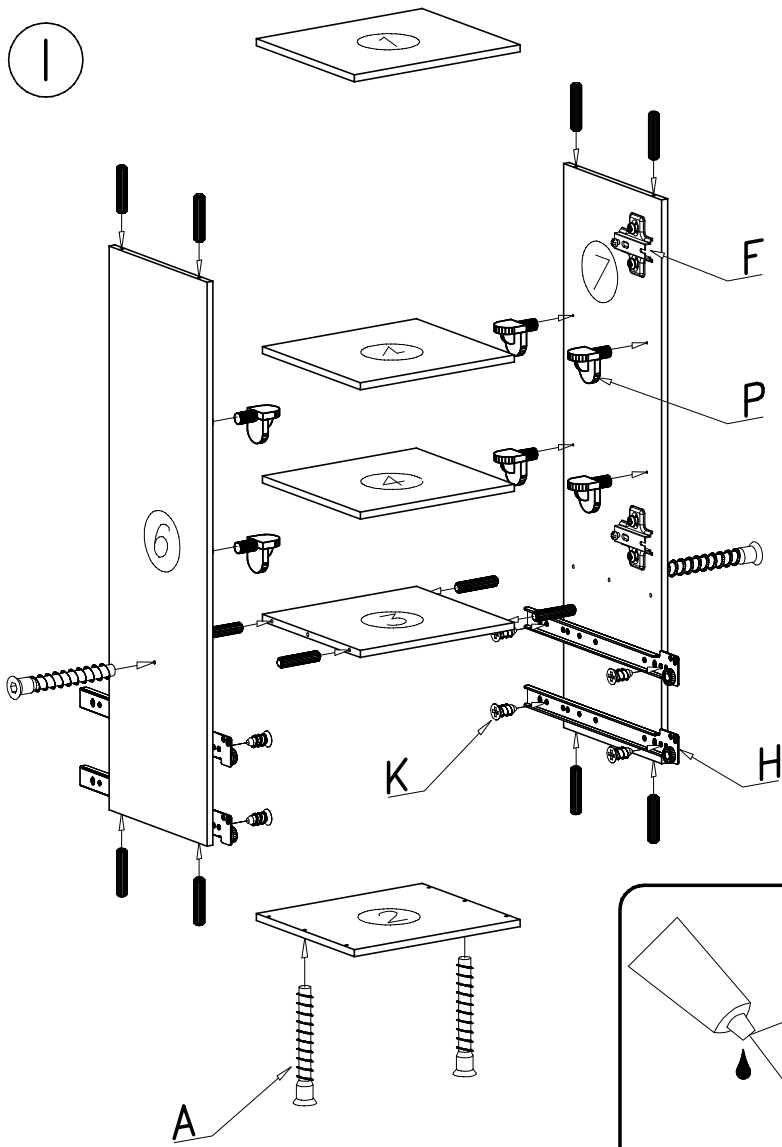
 x1

H

 35cm x2

I

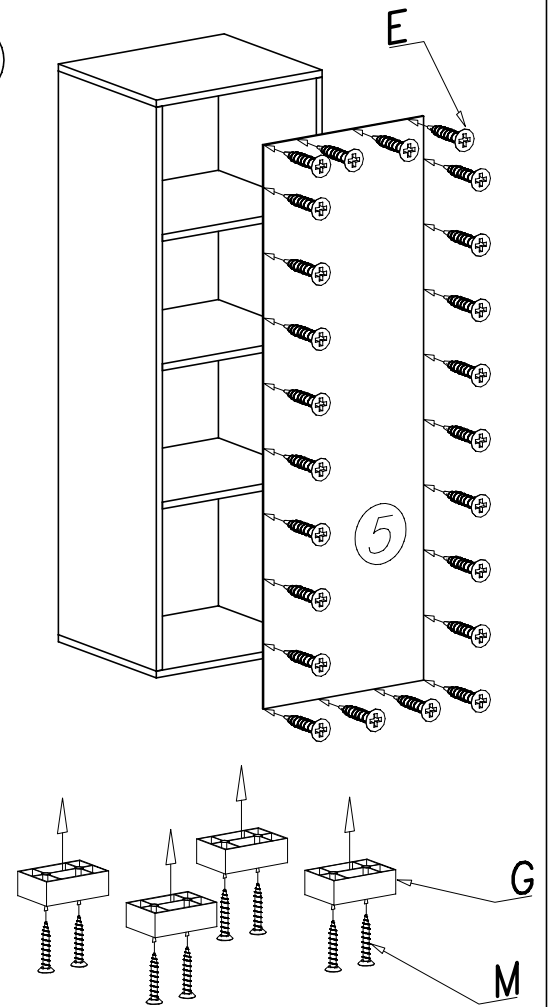

II



I

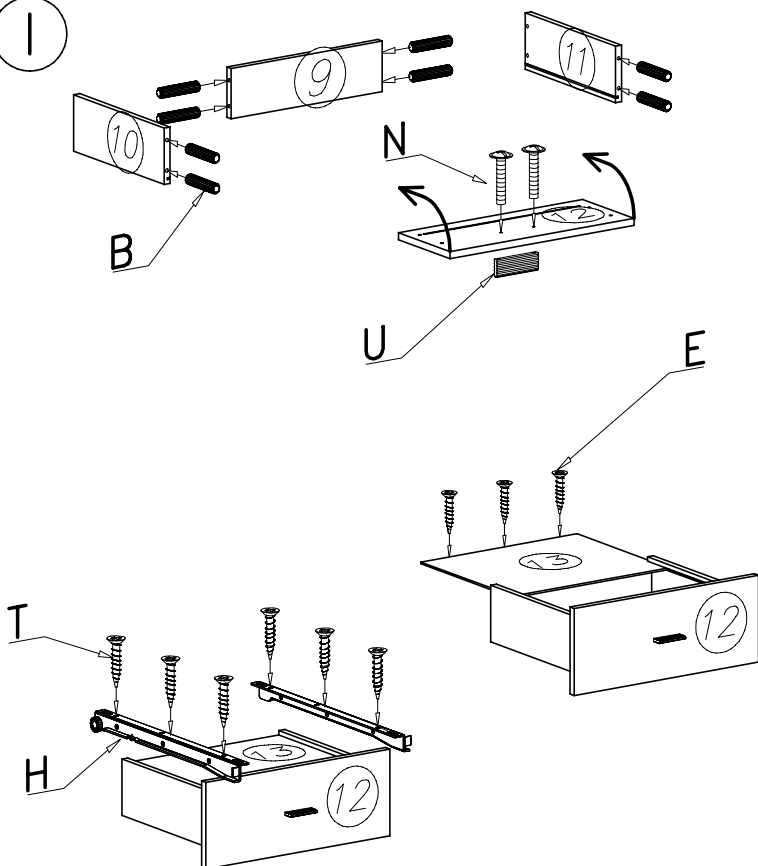

II

