

























30	30	52	12	6	9	8	2	1	6	2
										
B	A	D 8.0x35	W2 3.5x16	PZ	G	I 3.5x16	W4	U1	NP2	NP1
										
X	S3	KS	Z1	Z	PTS	O 3.0x20	W1	G3	WS	NP3
22	12	2	4	2	3	9	9	24	12	2

	
PD	F 6.3x13
3	36



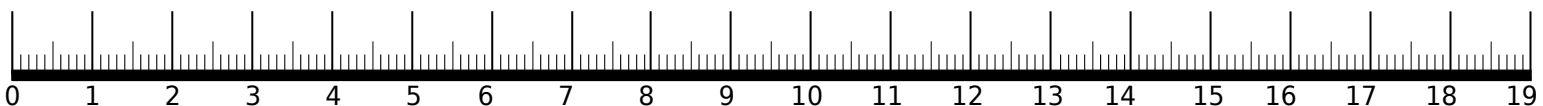
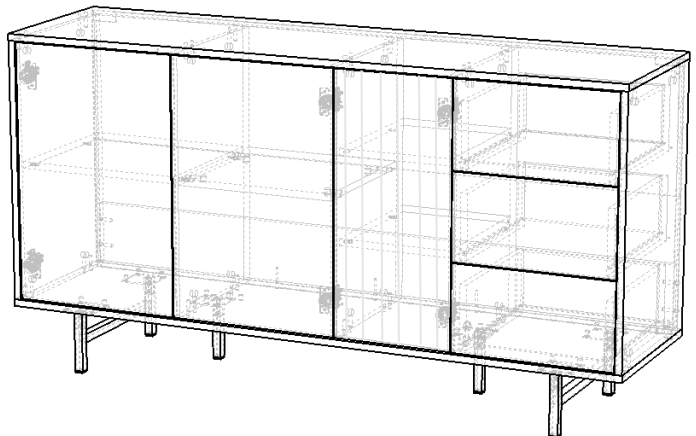
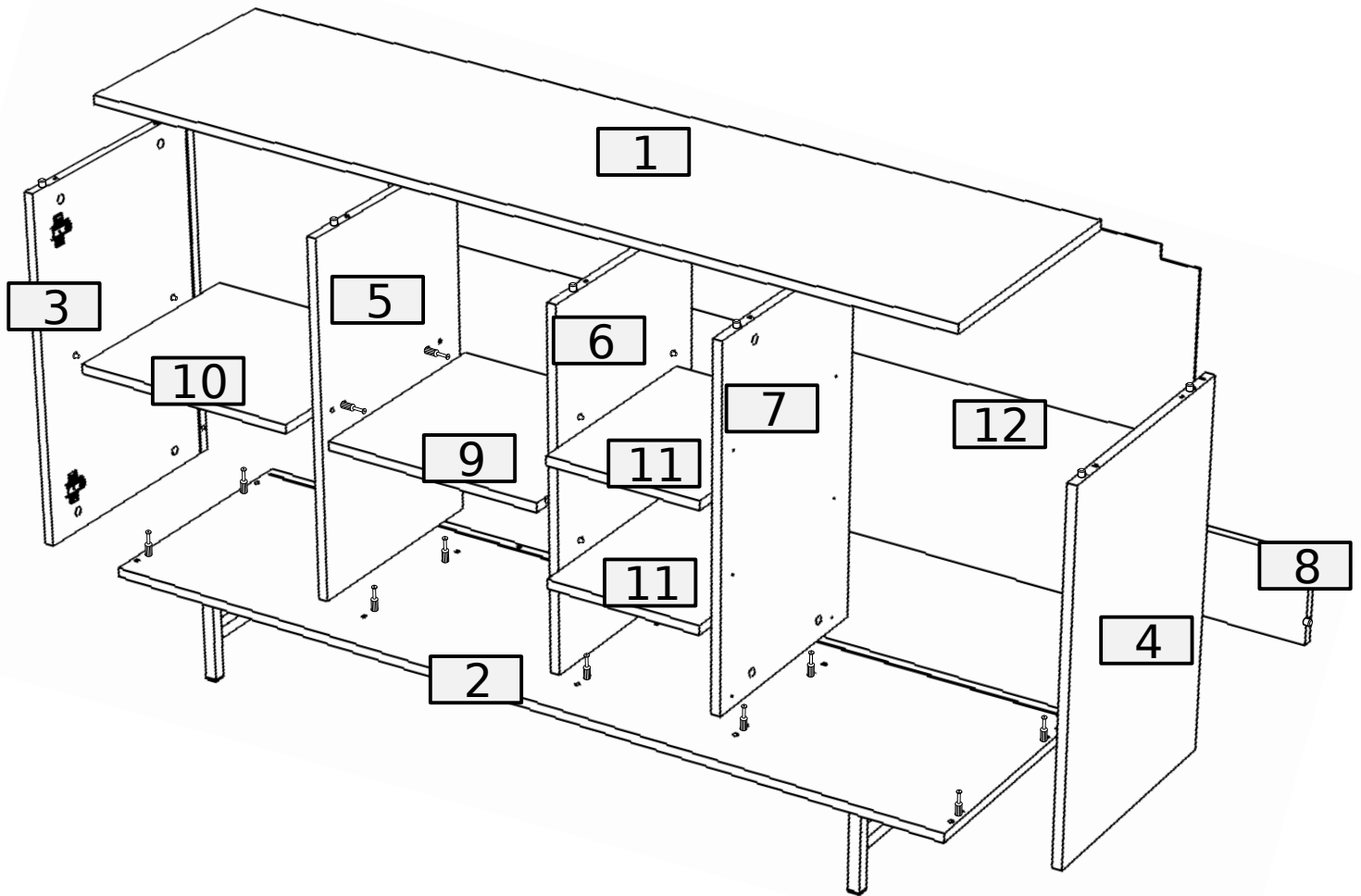

No.	Pcs.	L	W	D	Pac
1	1	1500	410	16	1/2
2	1	1500	410	16	1/2
3	1	618	409	16	2/2
4	1	618	409	16	2/2
5	1	618	370	16	2/2
6	1	618	370	16	2/2
7	1	618	370	16	2/2
8	1	1466	150	16	1/2
9	1	380	369	16	1/2
10	1	395	360	16	1/2
11	2	360	266	16	2/2
12	1	1480	632	3	1/2
13	3	350	160	16	2/2
14	3	336	142	16	2/2
15	3	350	160	16	2/2
16	3	357	351	3	1/2
17	3	376	202	16	1/2
18	2	612	400	16	1/2
19	1	612	280	16	1/2

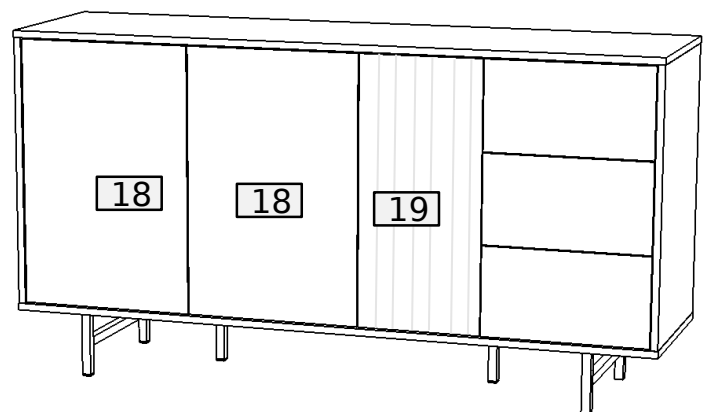
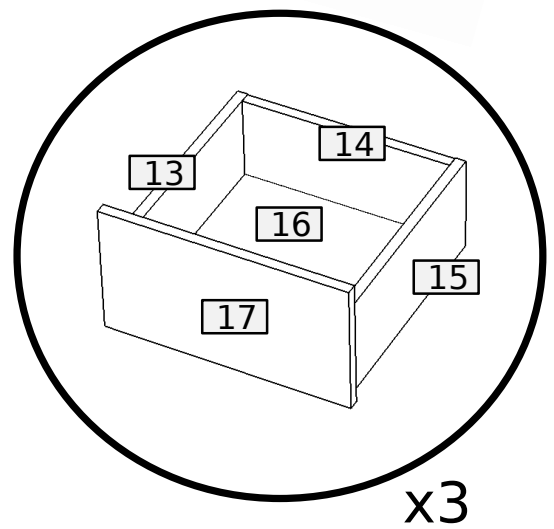

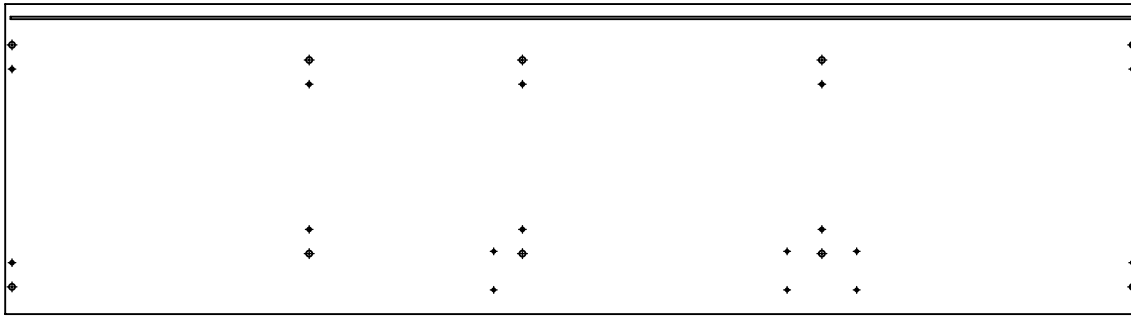

1. 1500x410x16 mm

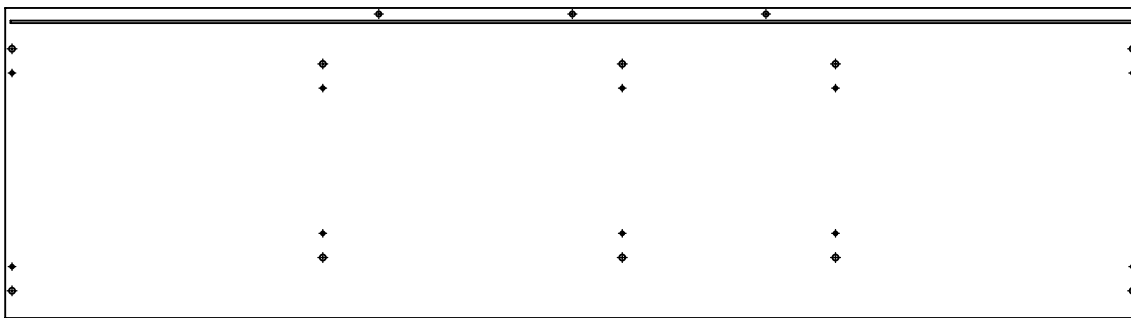

2. 1500x410x16 mm

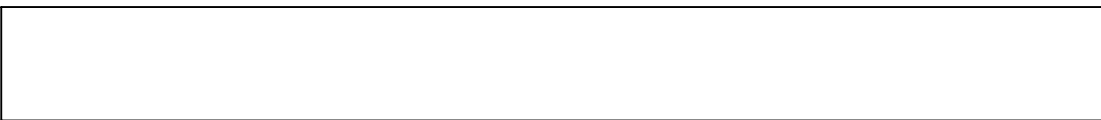

8. 1466x150x16 mm

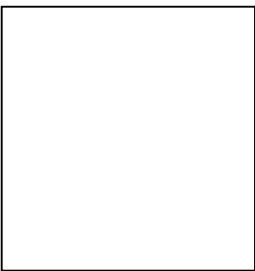

16. xxx mm x3

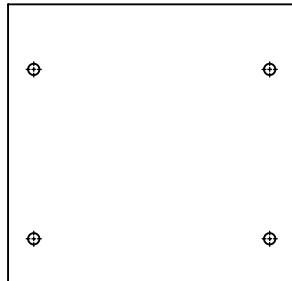

9. 380x370x16 mm

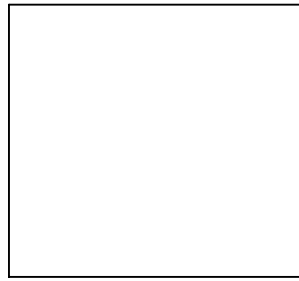

10. 395x360x16 mm



17. 376x202x16 mm x3

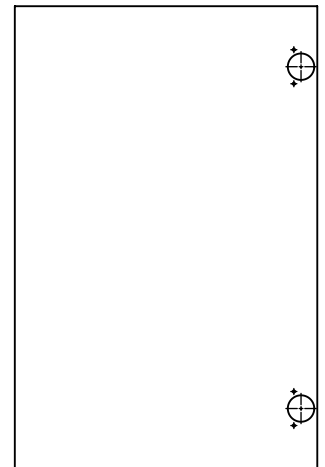

18. 612x400x16 mm x2



12. 1480x632x3 mm

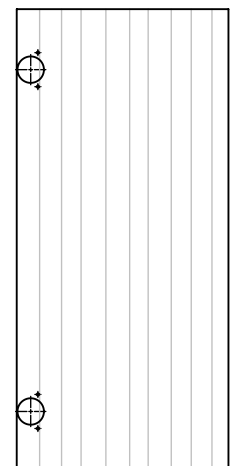

19. 612x280x16 mm

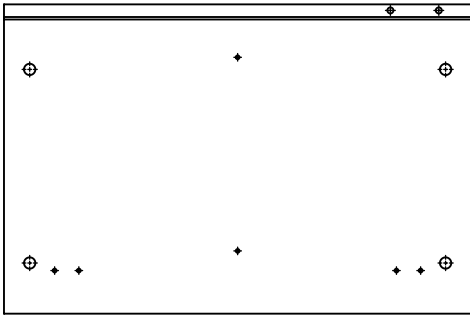

3. 618x409x16 mm

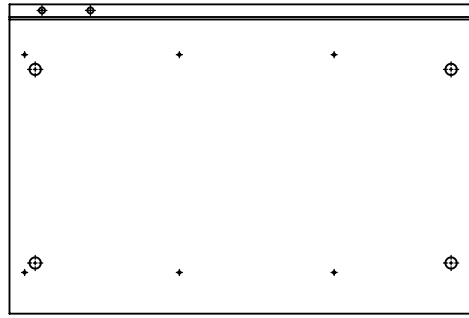

4. 618x409x16 mm

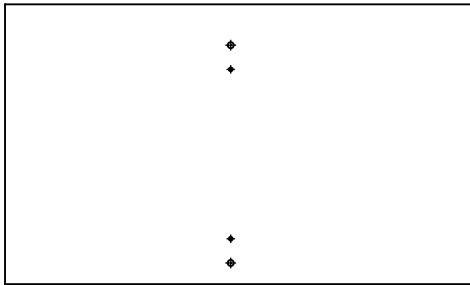

5. 618x370x16 mm

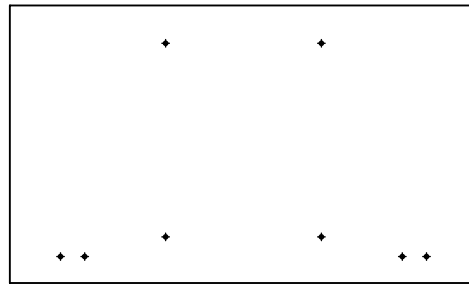

7. 618x370x16 mm

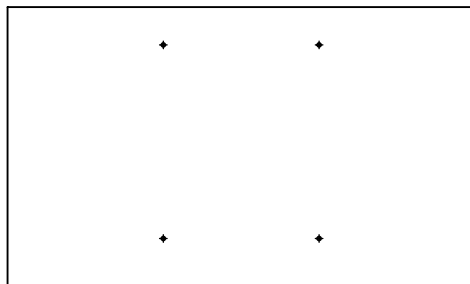

6. 618x370x16 mm

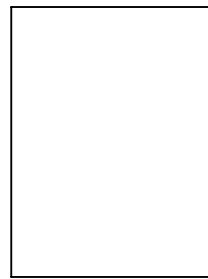

11. 360x266x16 mm x2

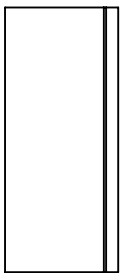

13. 350x160x16 mm x3

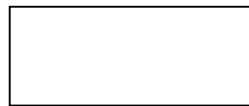

14. 336x142x16 mm x3

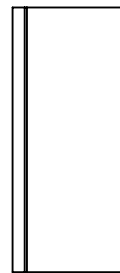

15. 350x160x16 mm x3

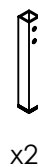
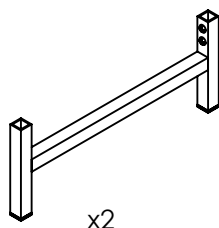
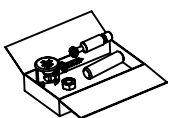

1

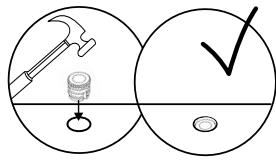

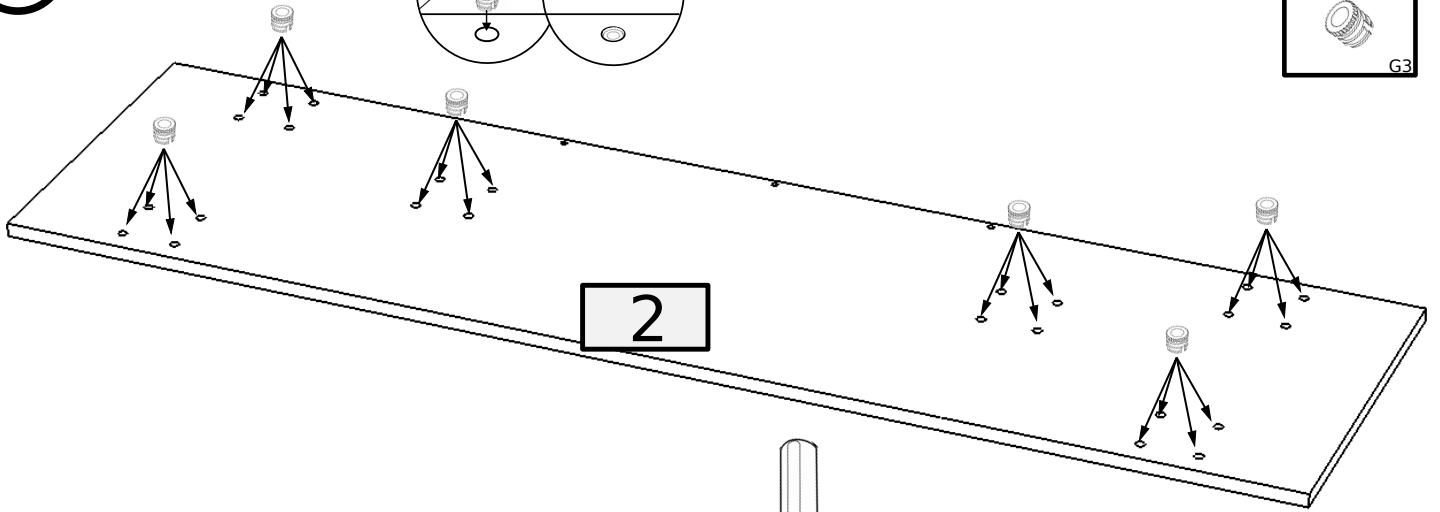

24

G3

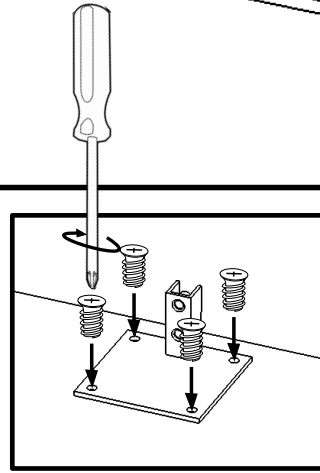

2



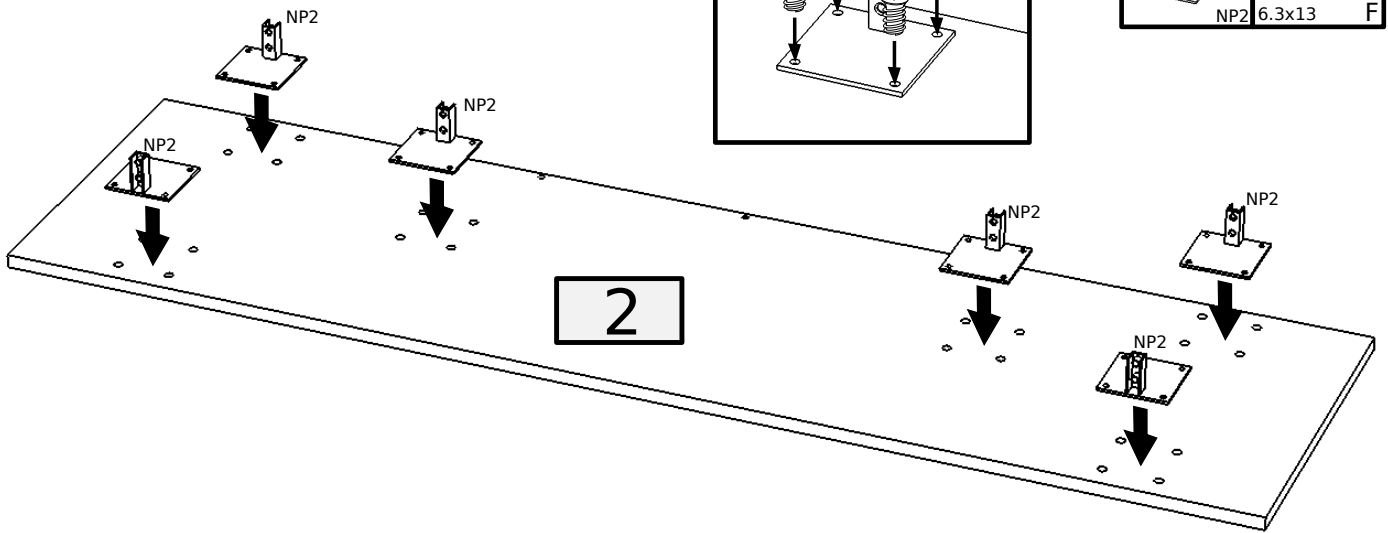

6	24
	
NP2 6.3x13	F

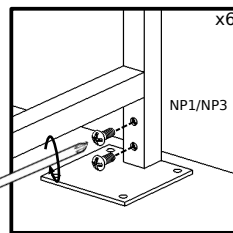

3





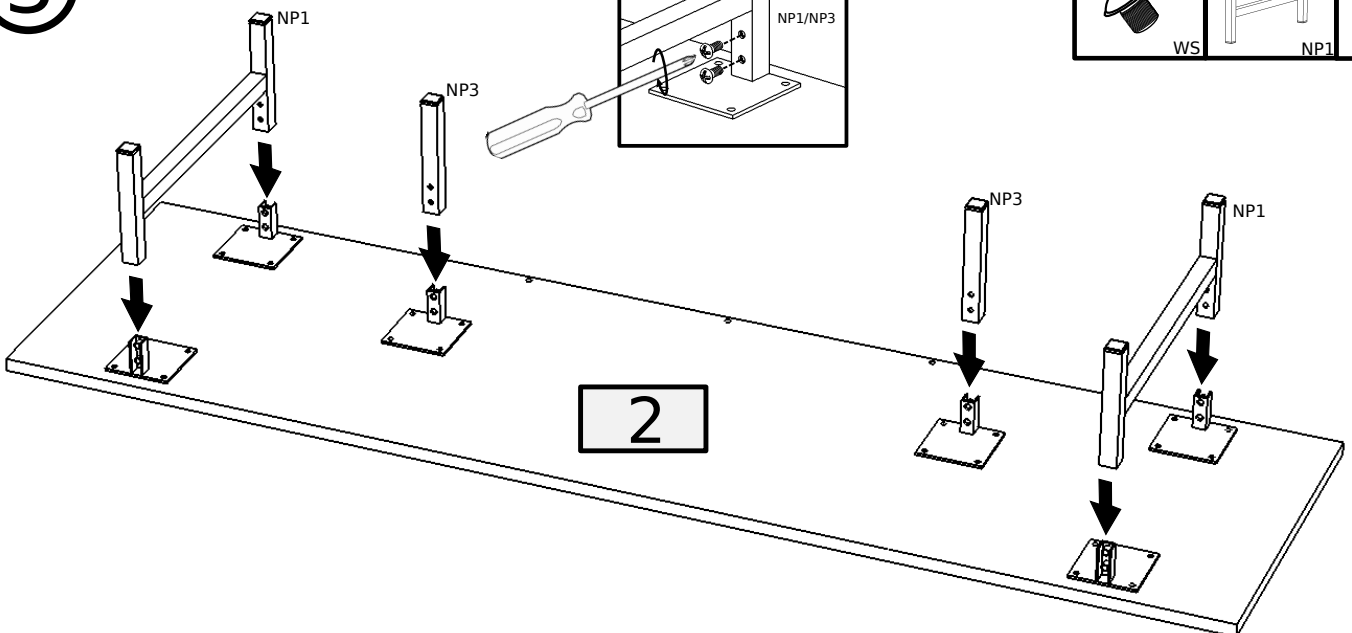

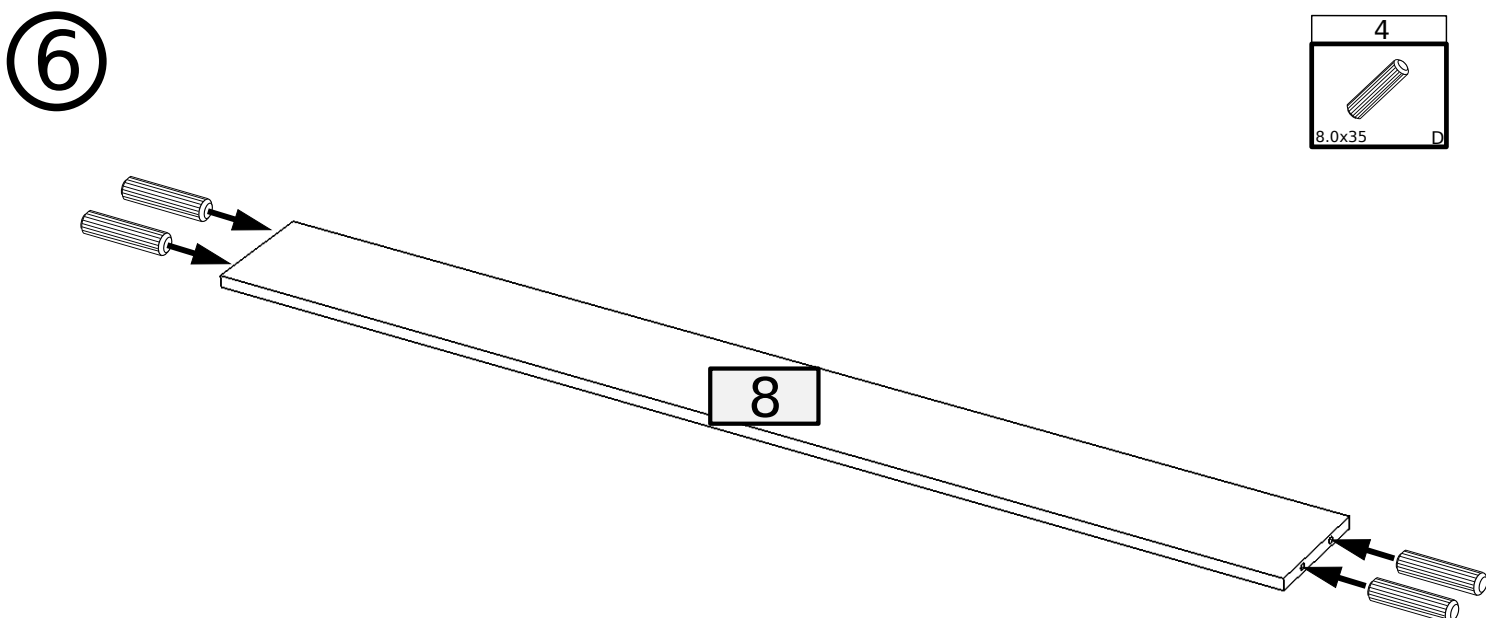
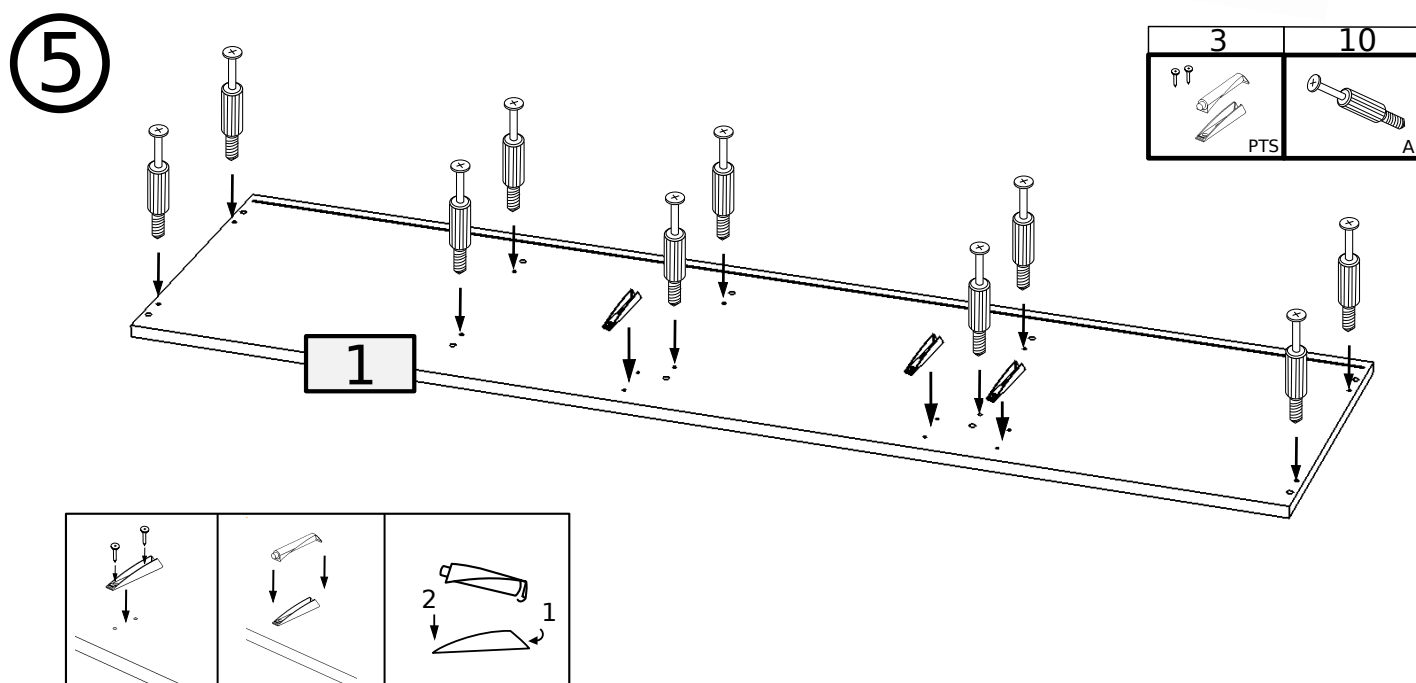
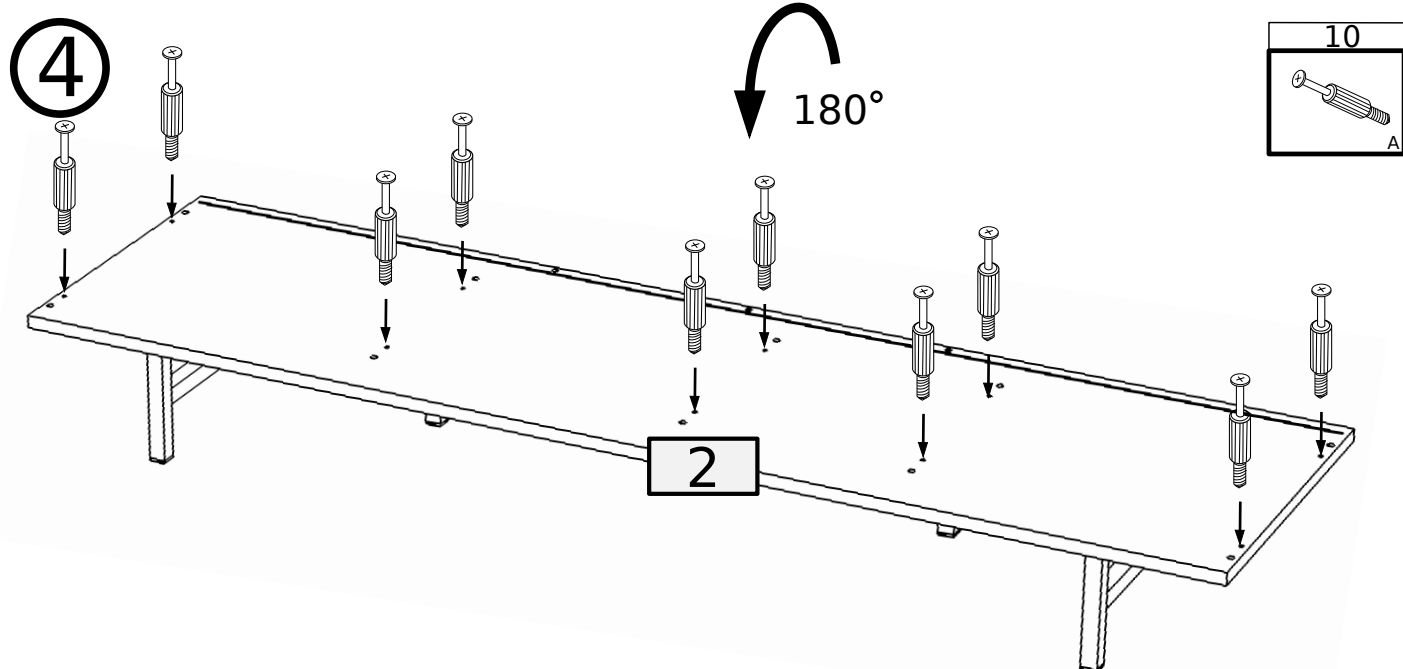
12	2	2
		
WS	NP1	NP3





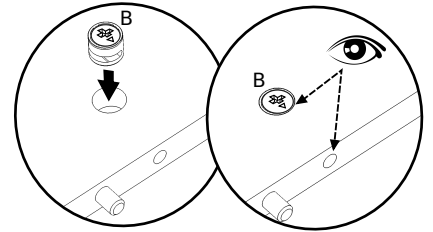
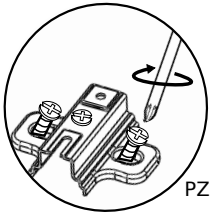
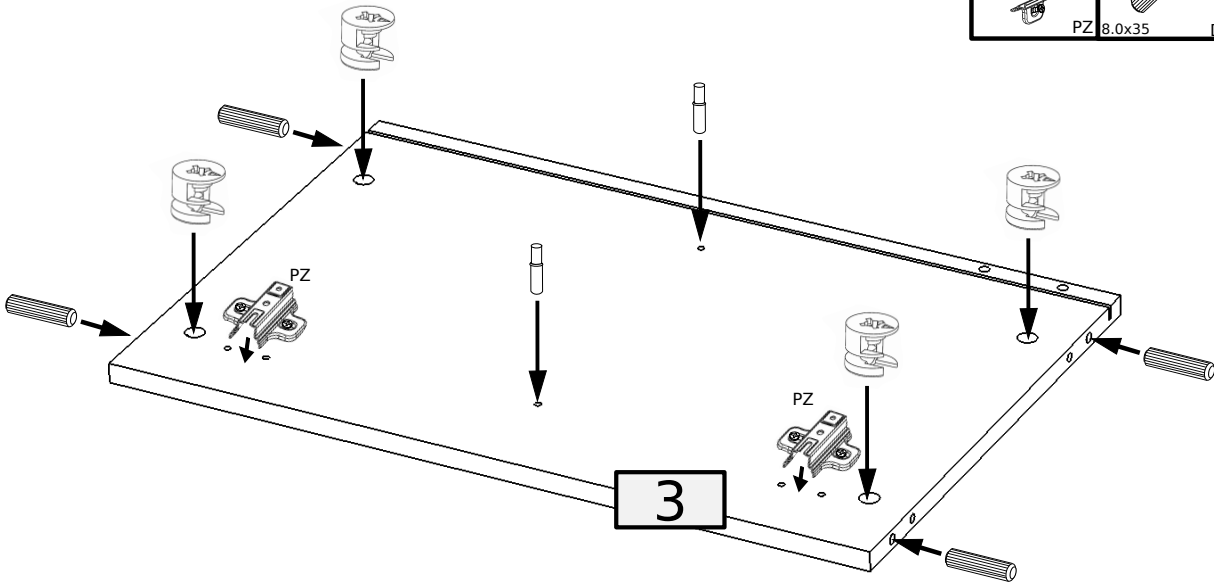

7

2	4	4	2
			
PZ	8.0x35	D	B
			S3



8

4	4
	
8.0x35	D
	B

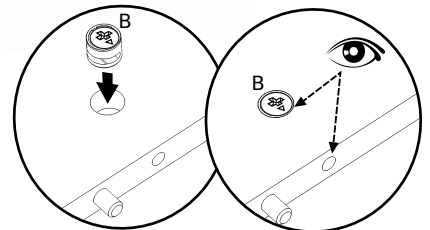
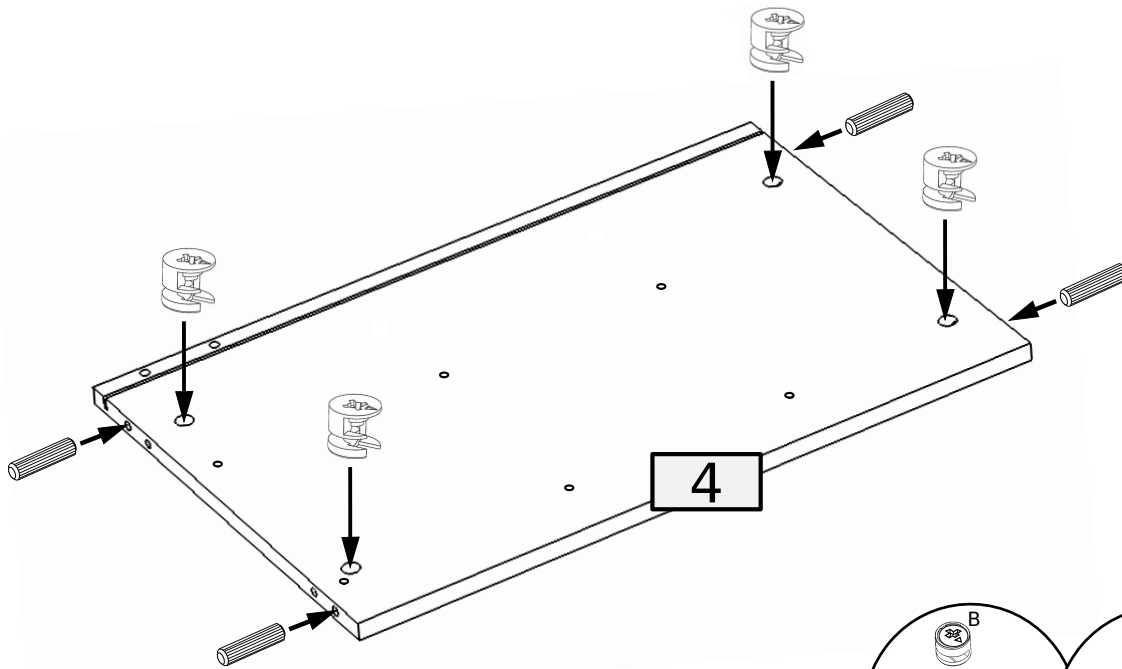



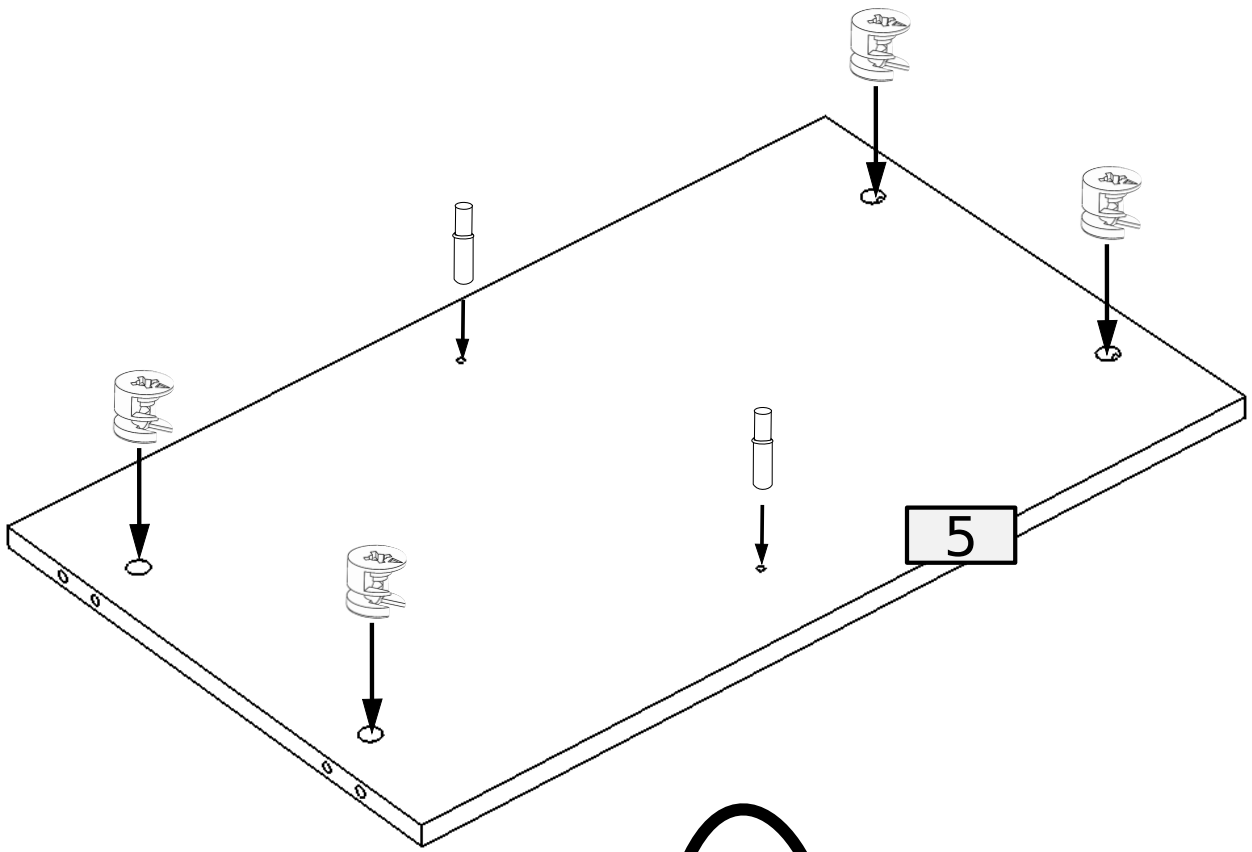

9

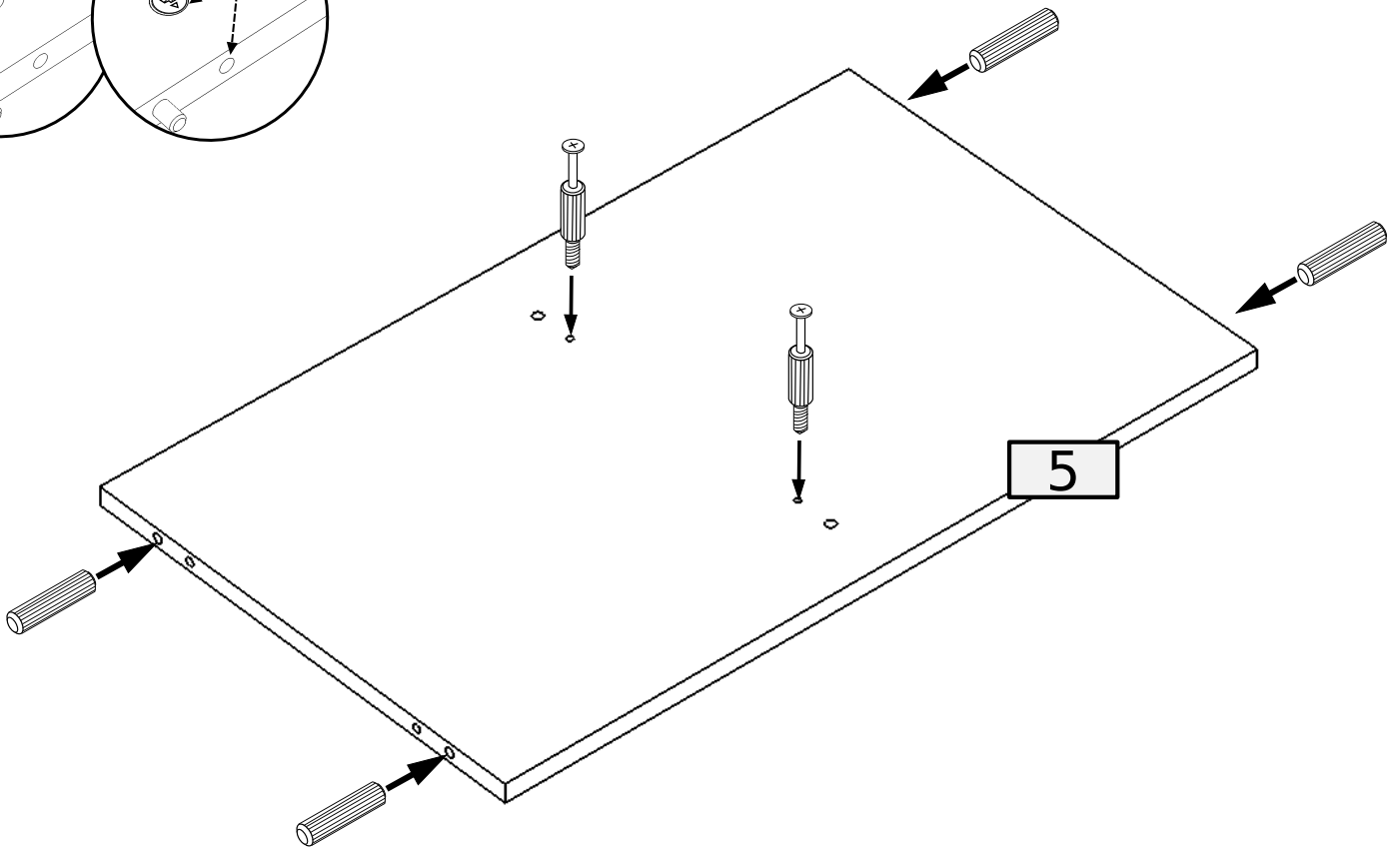
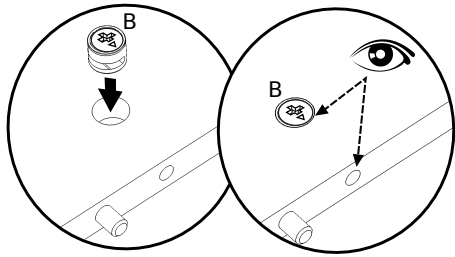



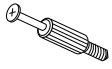



180°

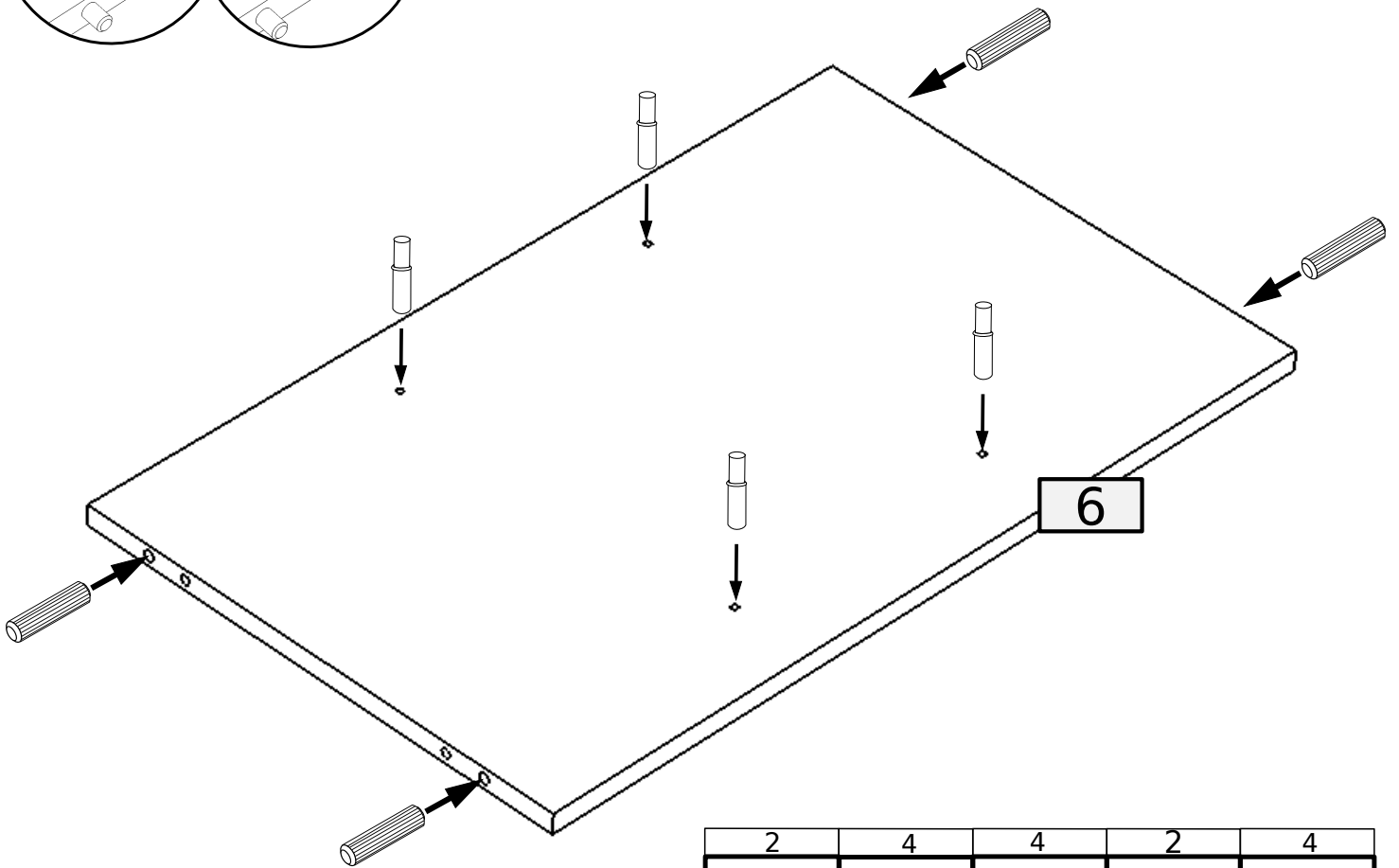
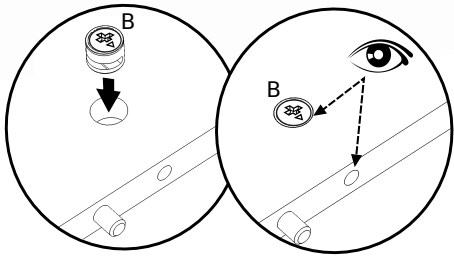
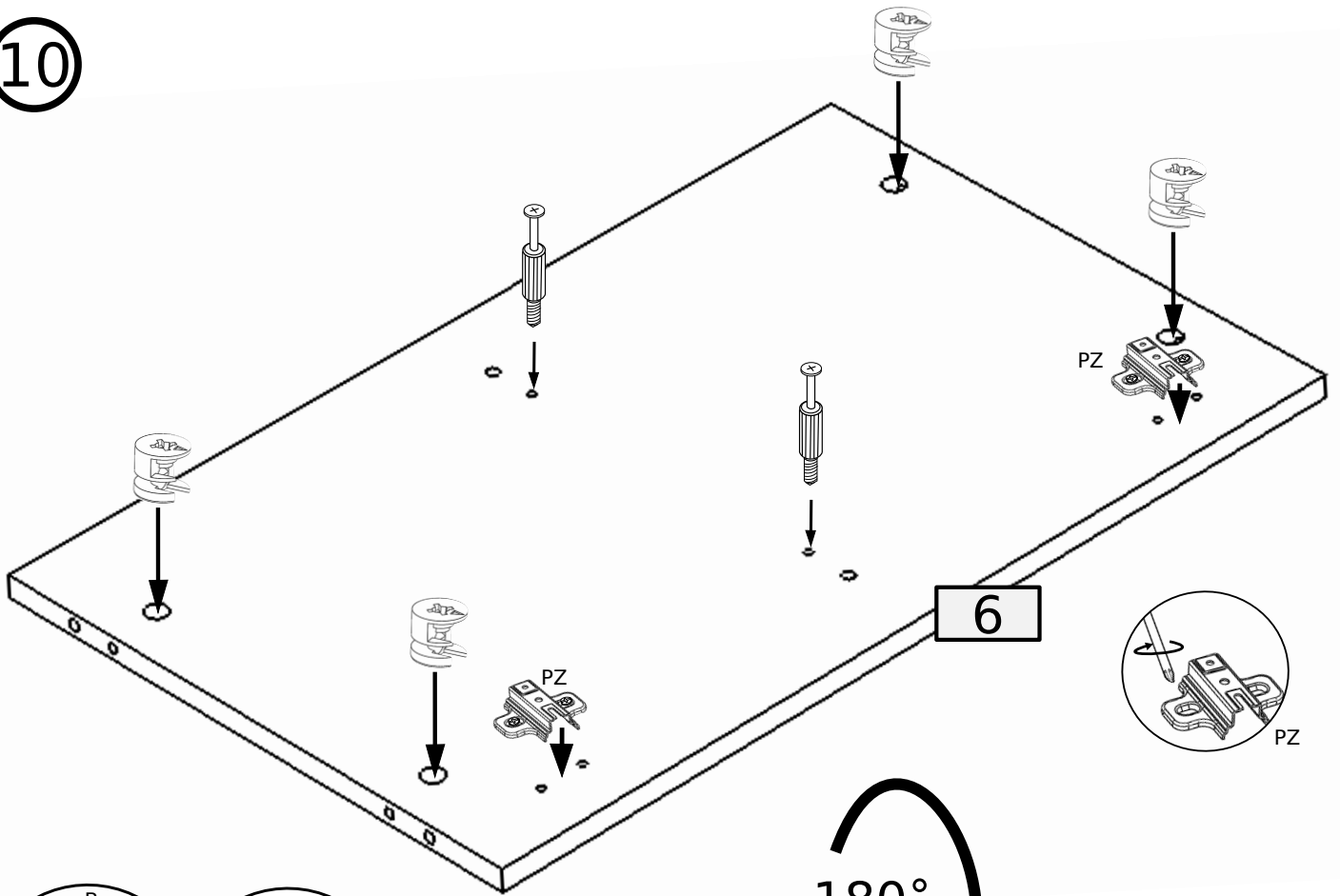

2	4	2	4
			
S3	B	A	8.0x35 D

10

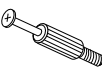

2	4	4	2	4
 PZ	 S3	 B	 A 8.0x35	 D



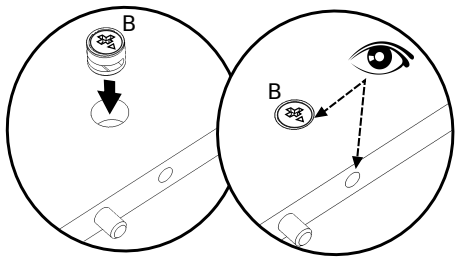
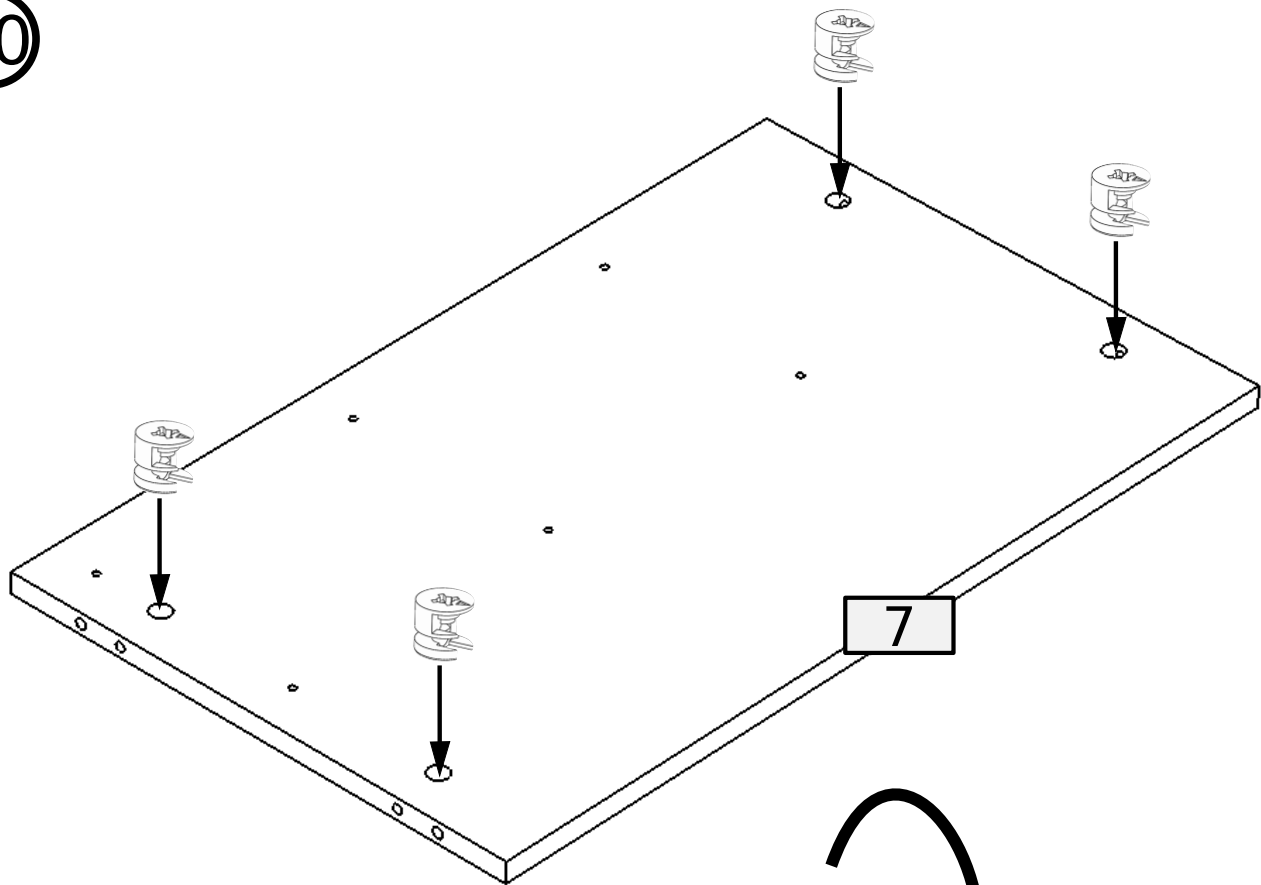

10

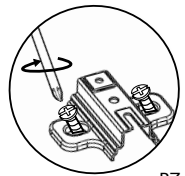
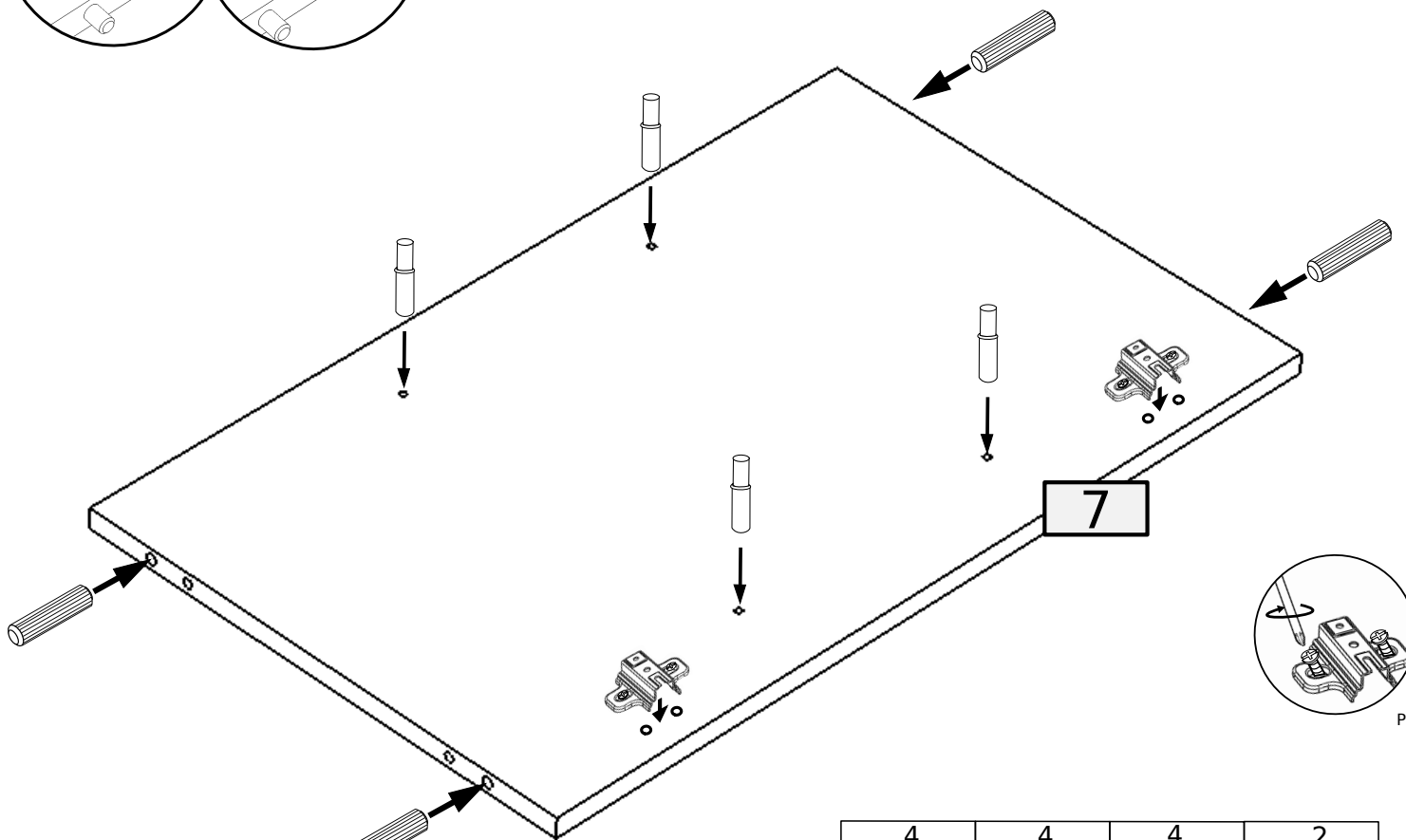



180°



PZ



4	4	4	2
			
S3	8.0x35	B	PZ

11

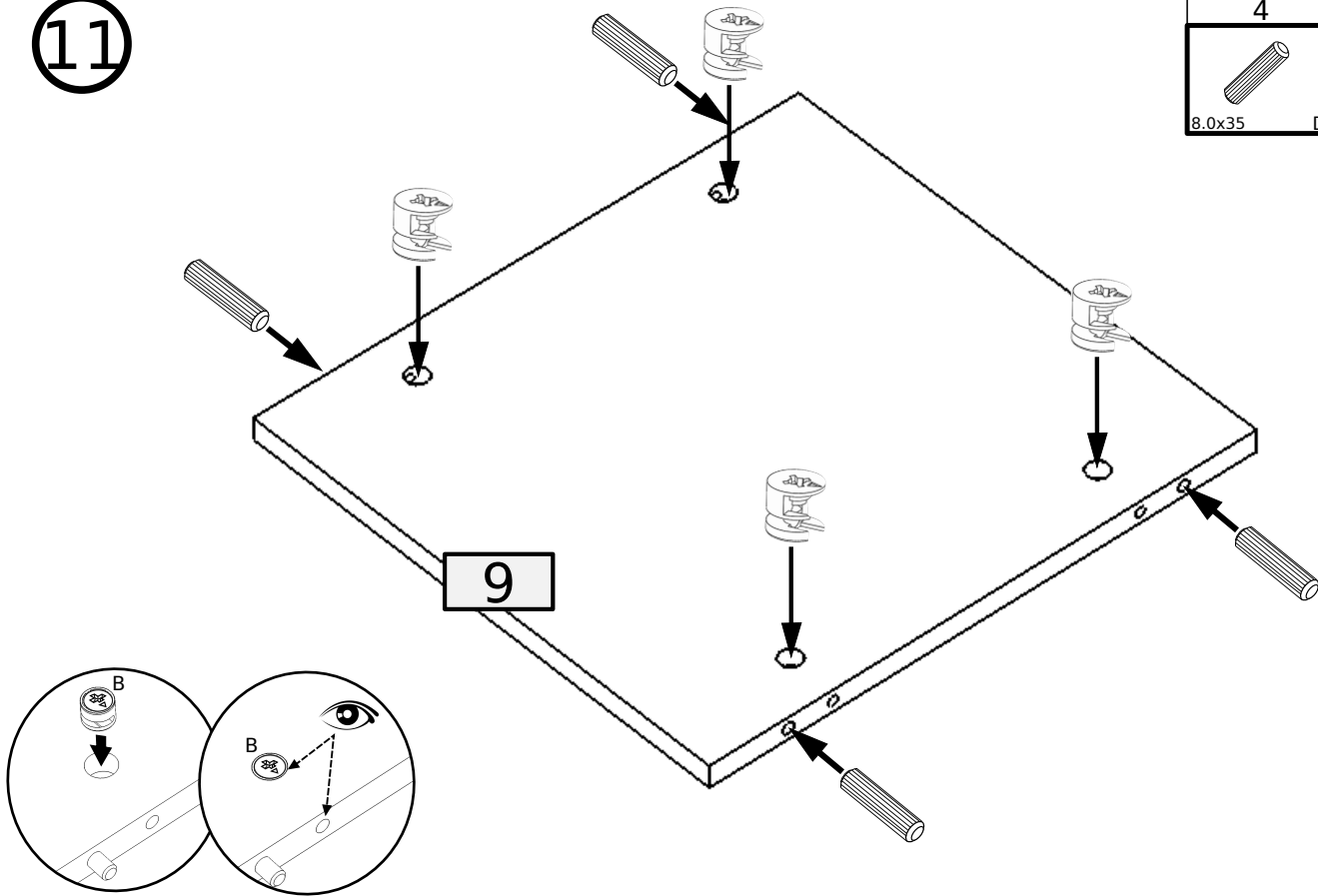

4	4
	
8.0x35	D B

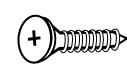

12

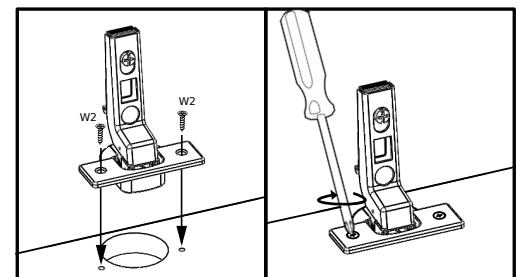
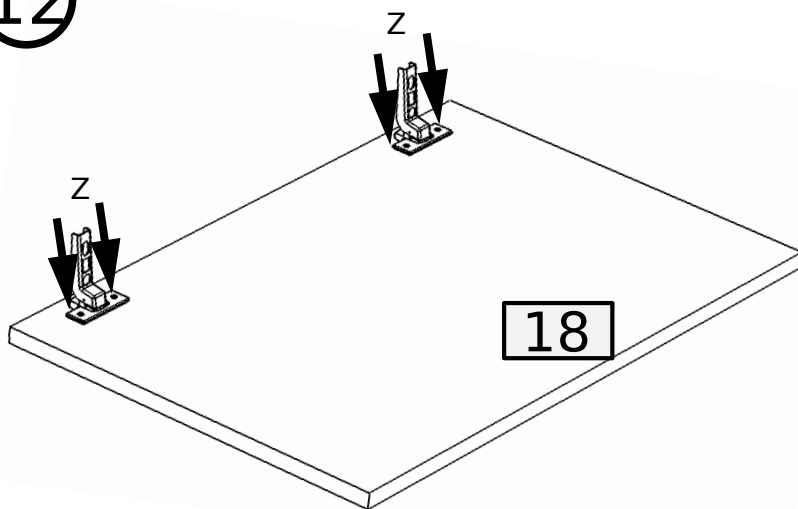
	
3.5x16	W2
4	2

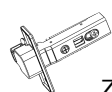

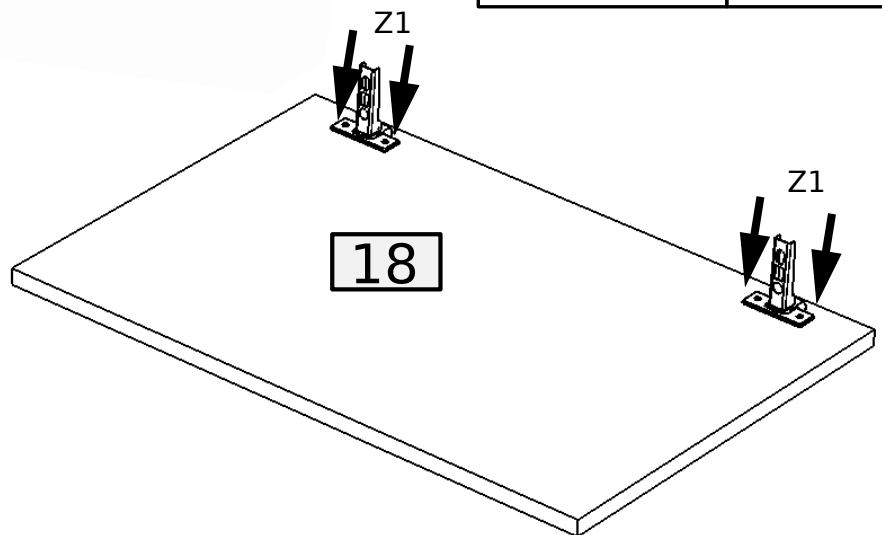

	
Z1	3.5x16 W2
2	4

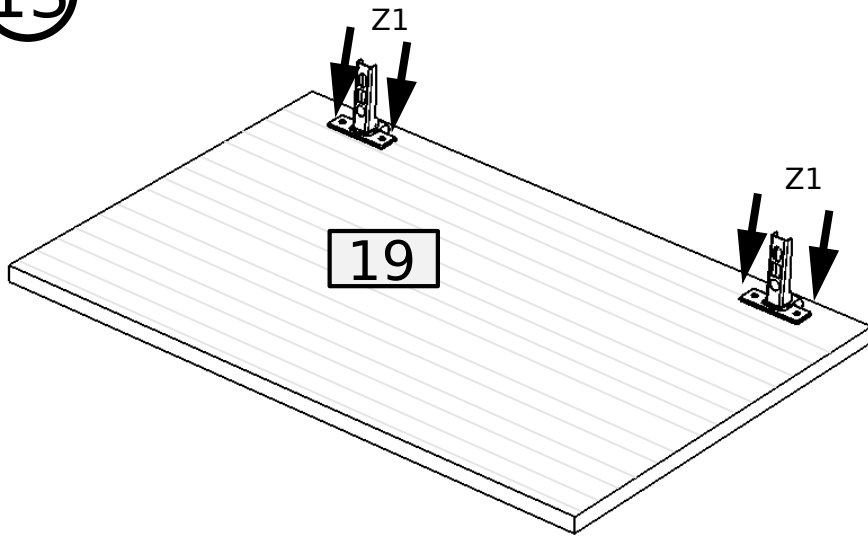

13

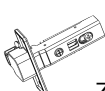

	
Z1	3.5x16 W2
2	4

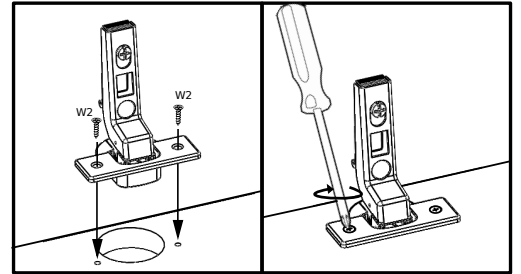

14

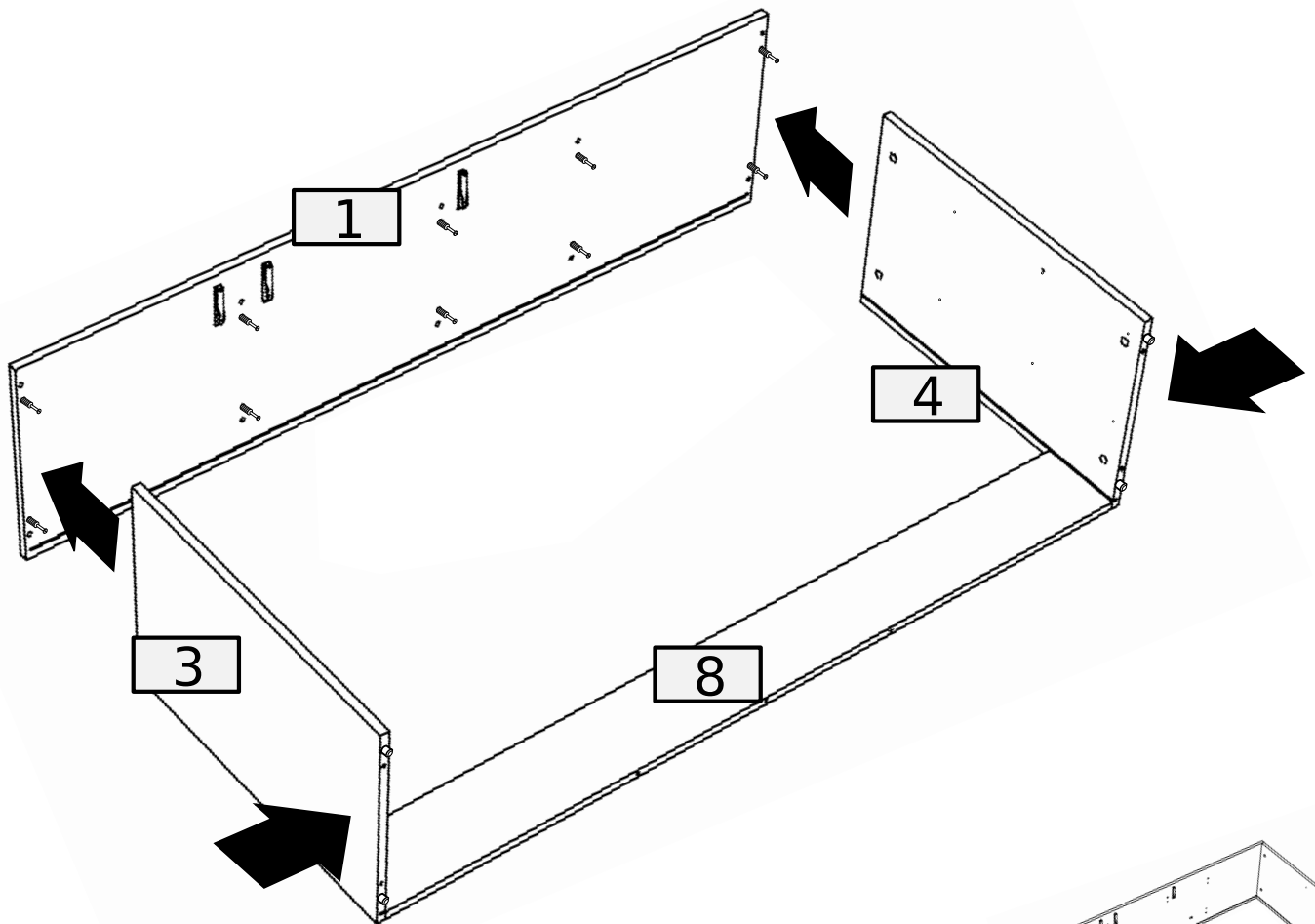
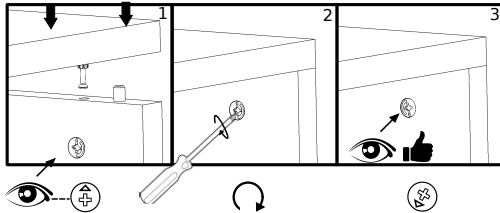

15

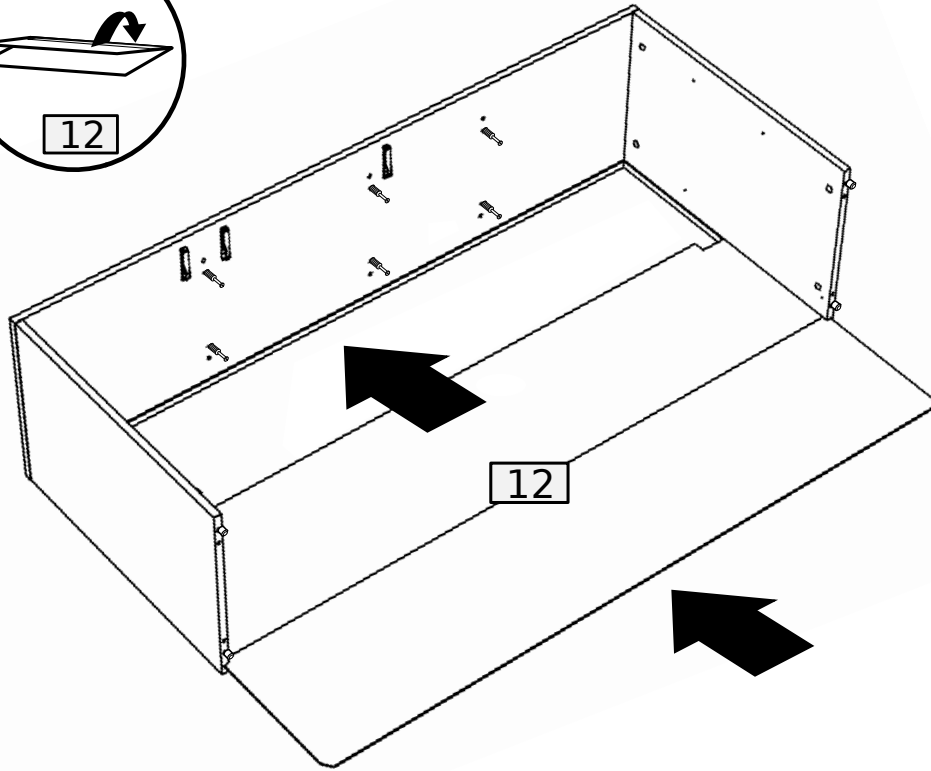

16

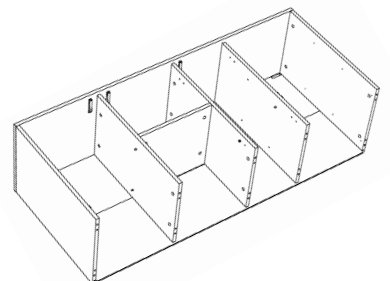
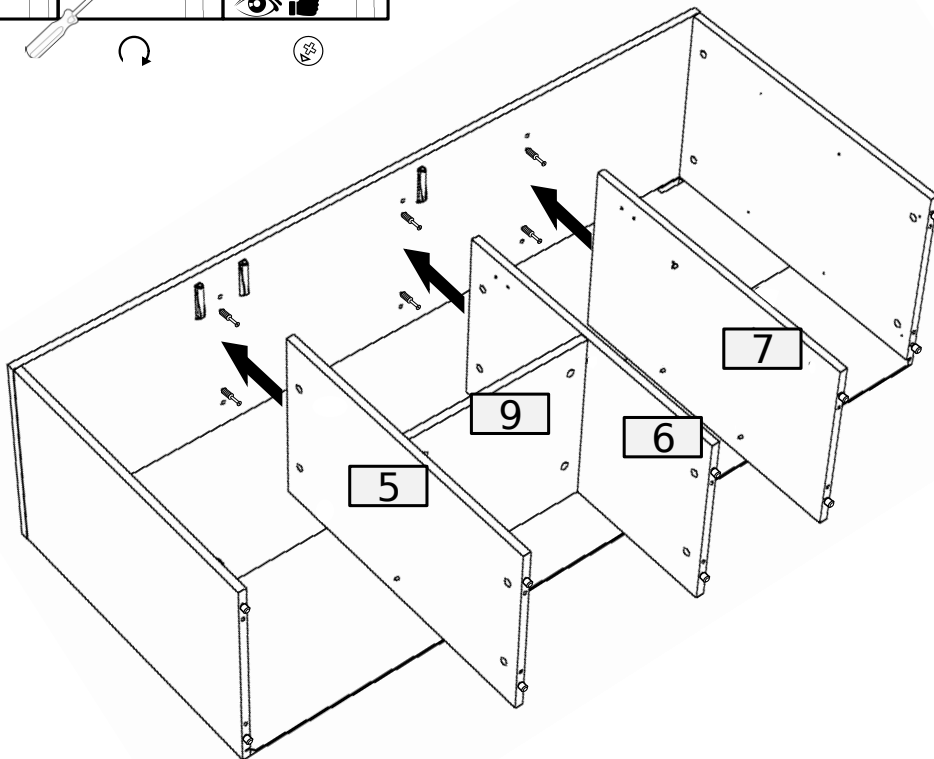
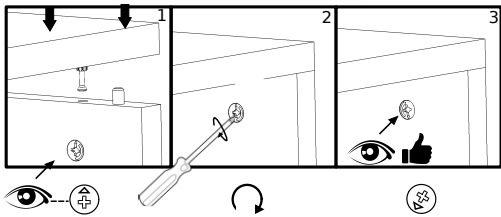

17

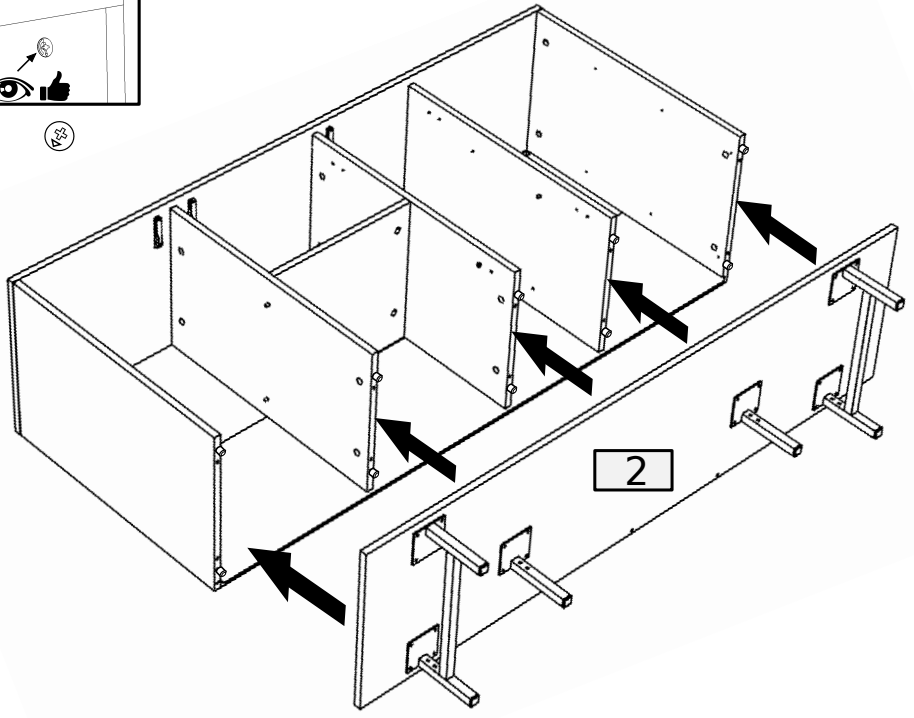
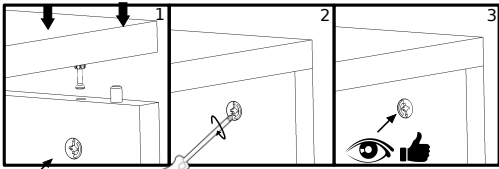

18

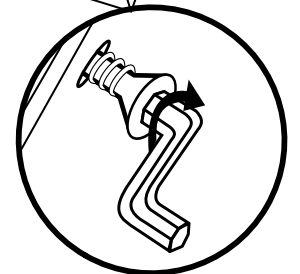
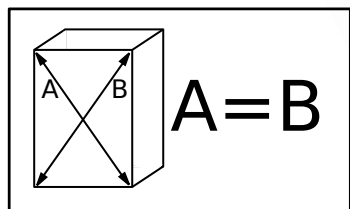
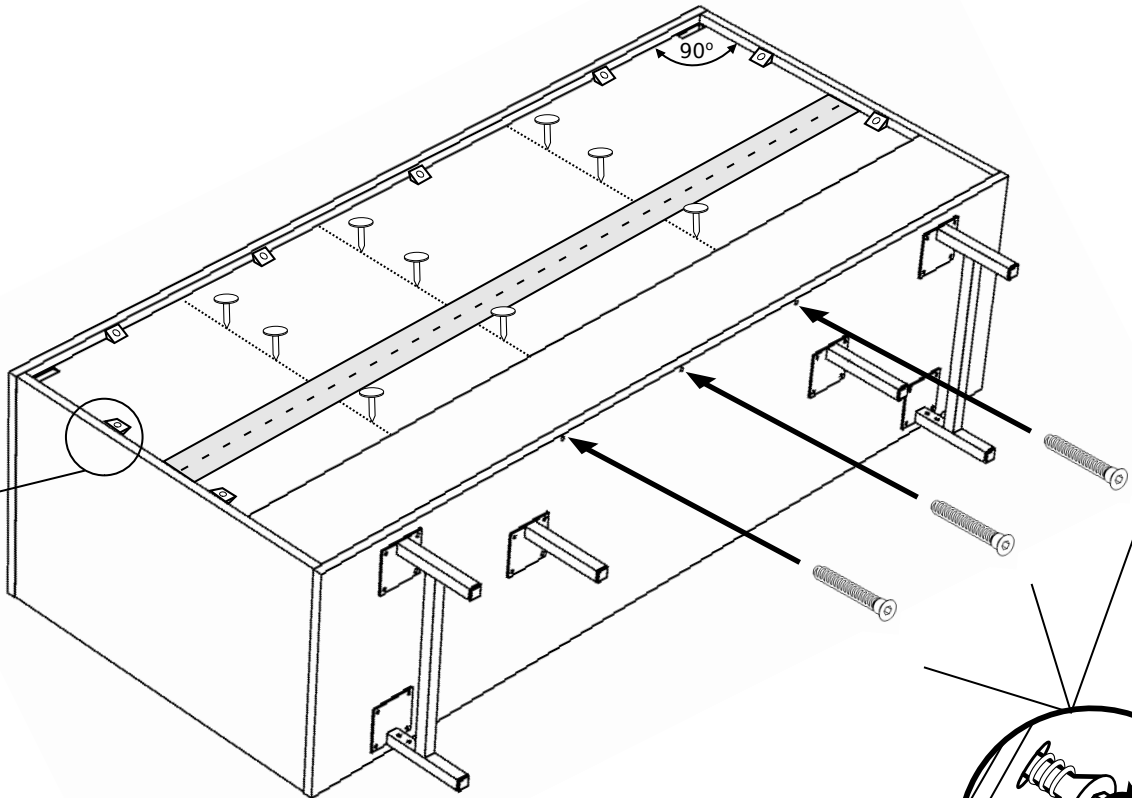
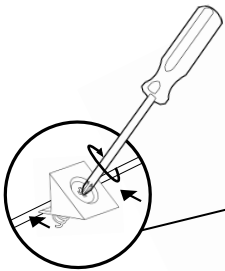
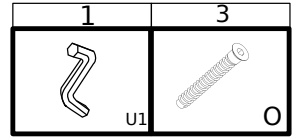
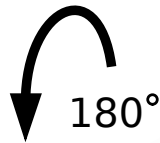
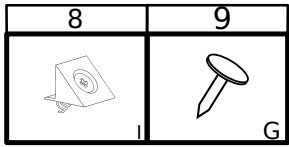

19

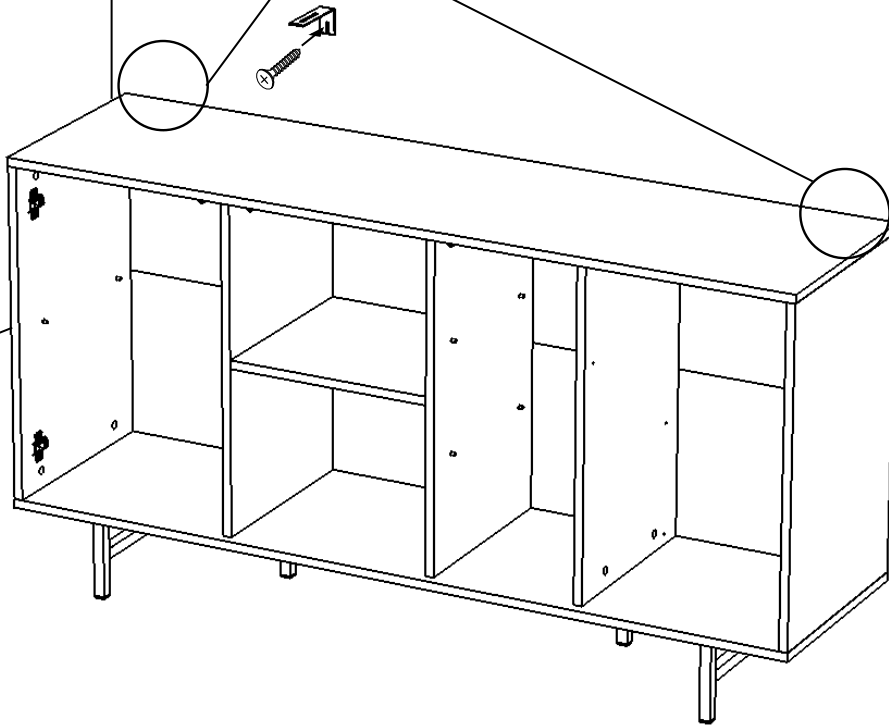
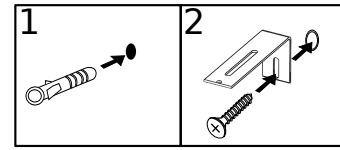
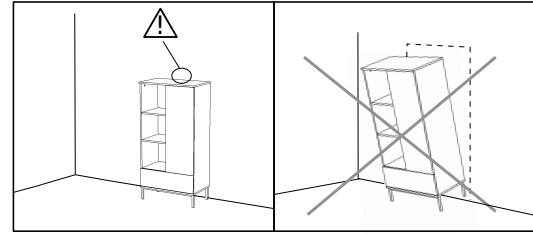
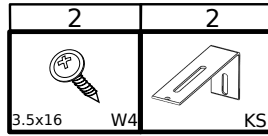
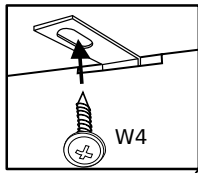

20

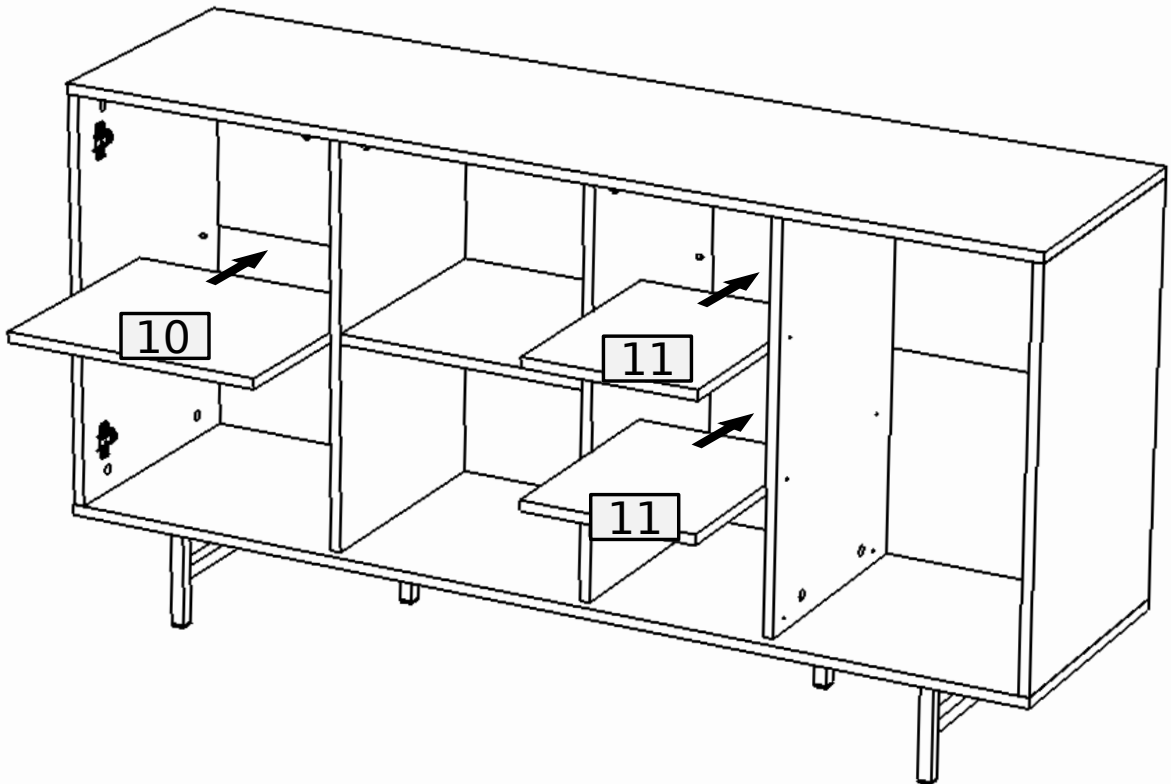

21 x3

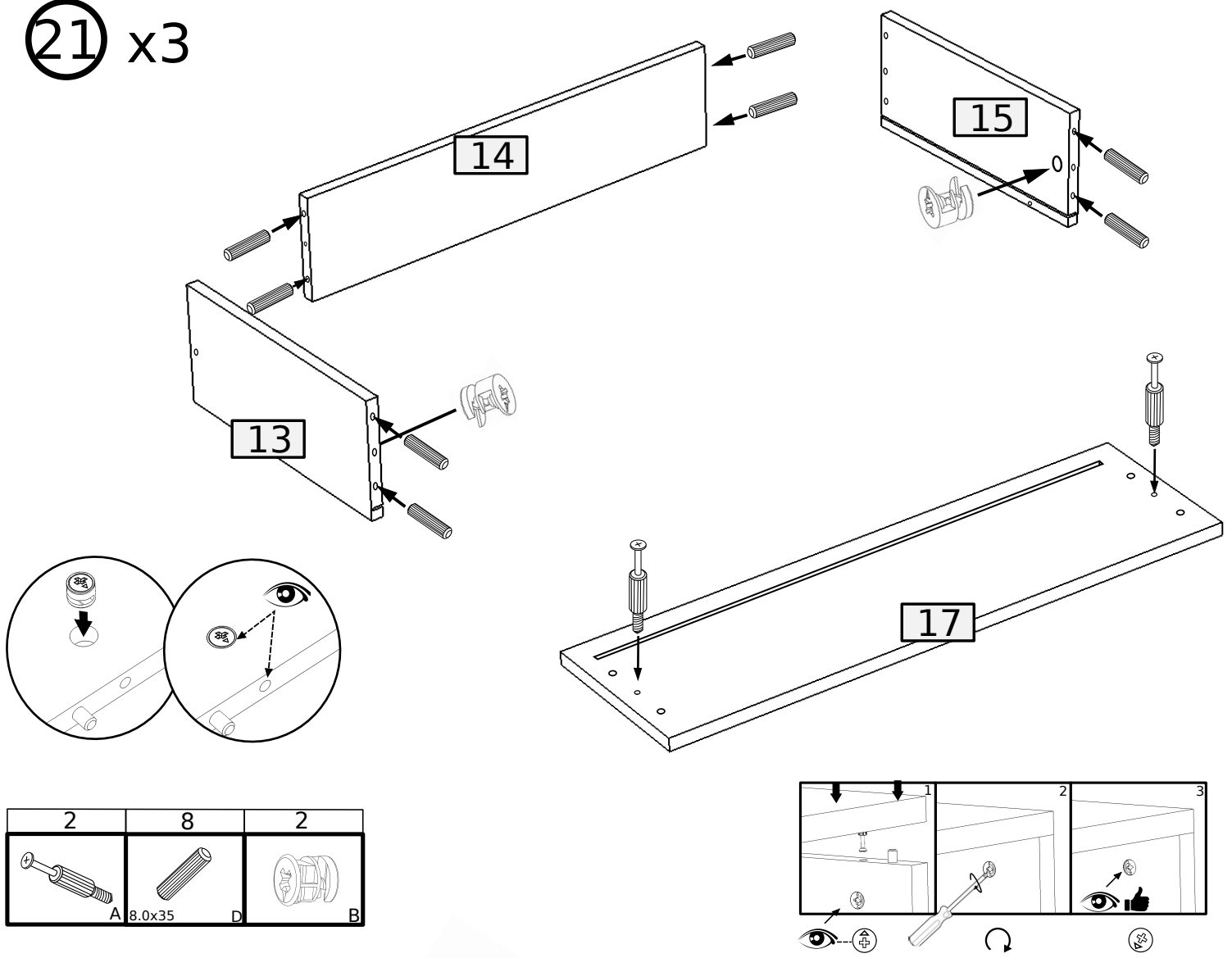

22 x3

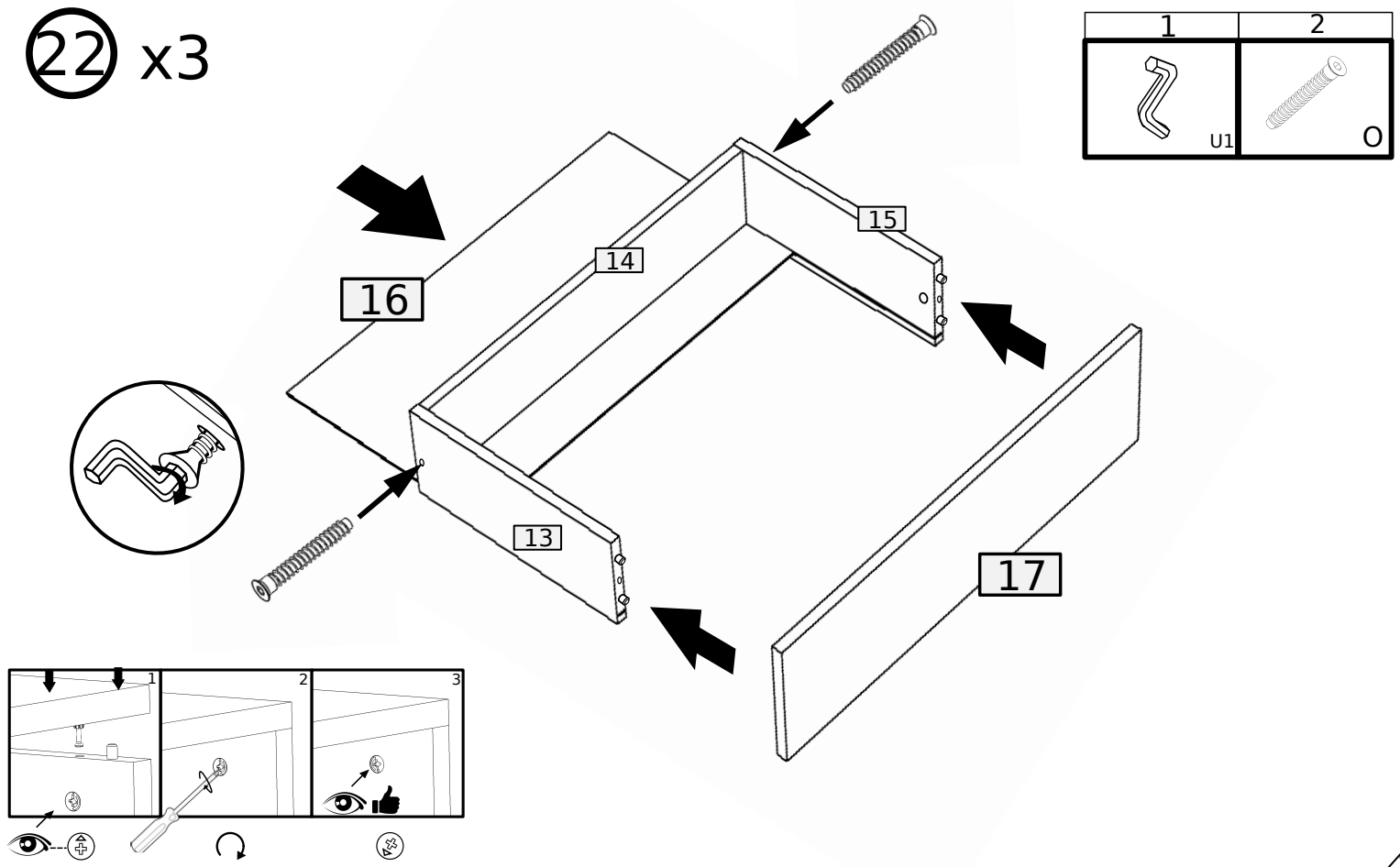

23 x3

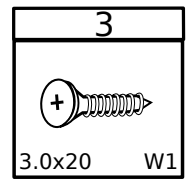
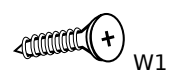
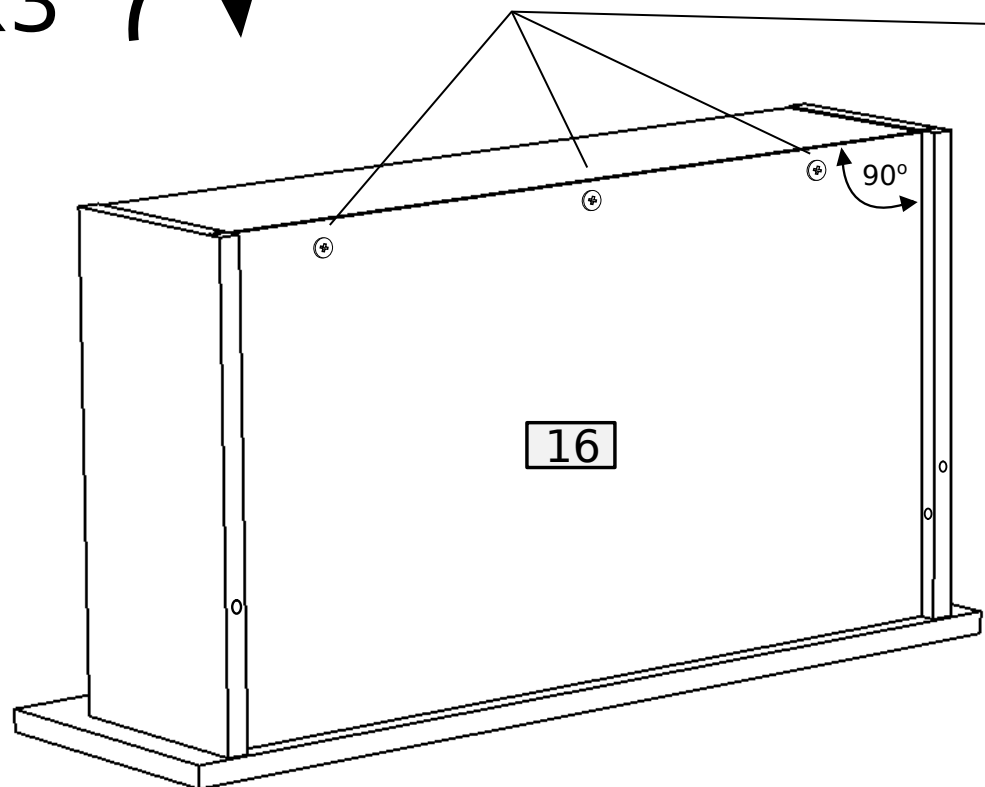

23

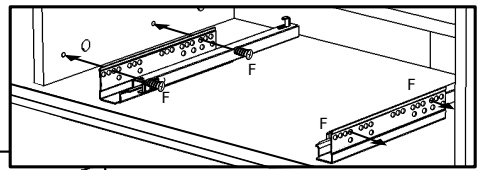
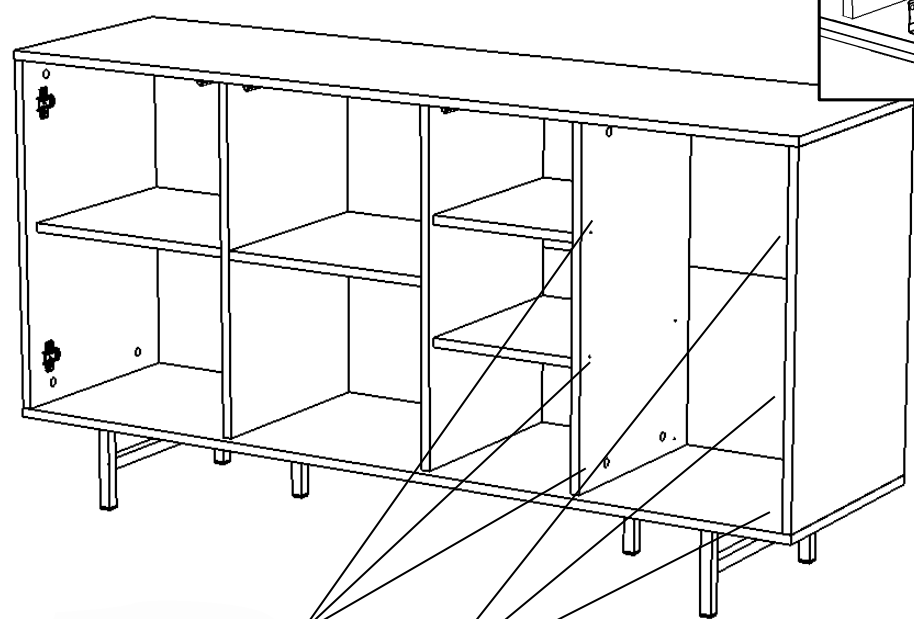

x3

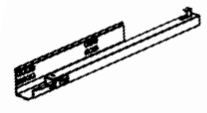

PD

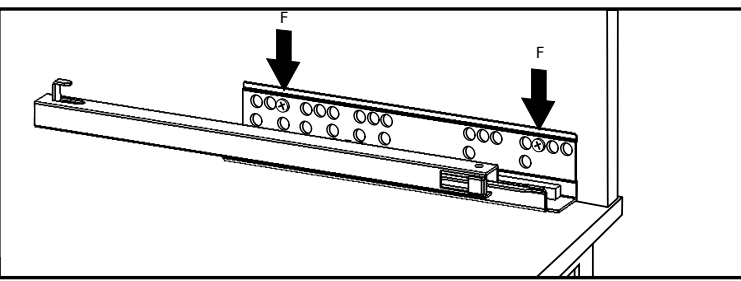
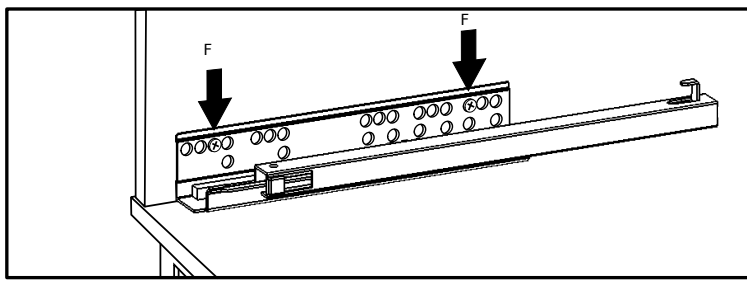
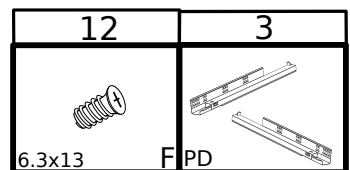
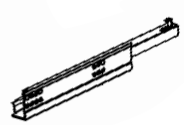

24 x3

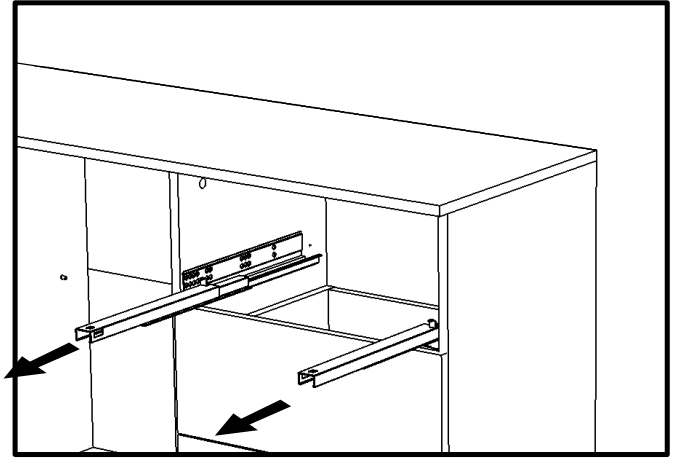
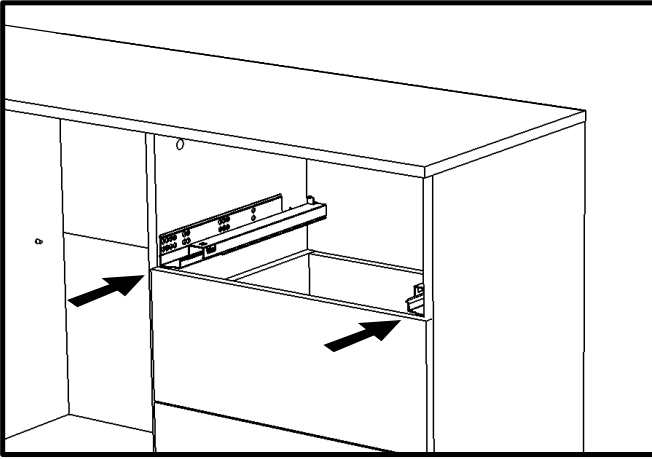

25
x3

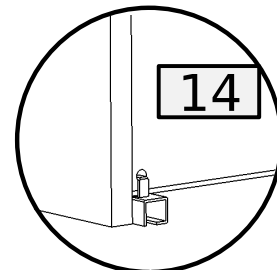
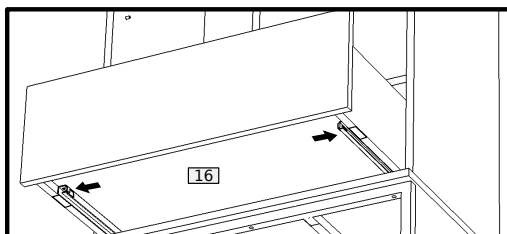
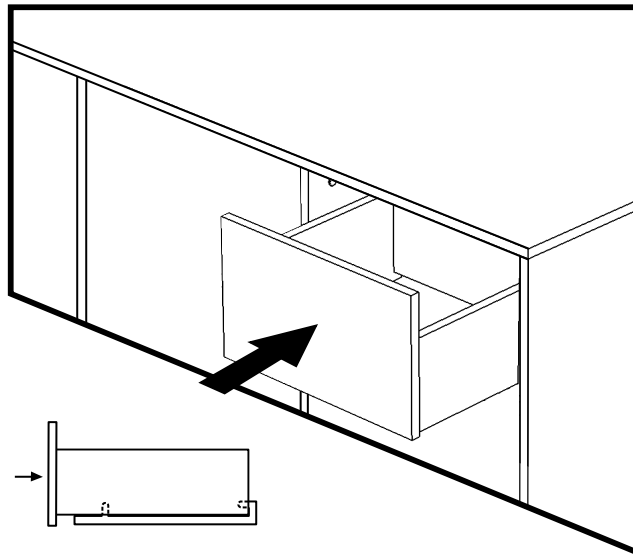
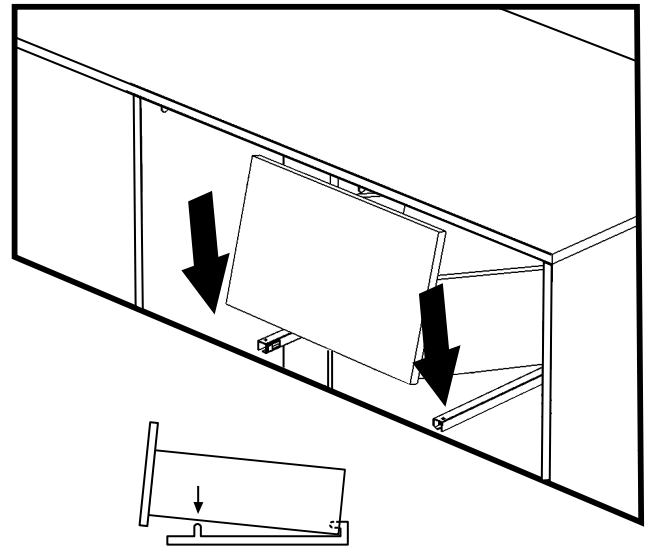
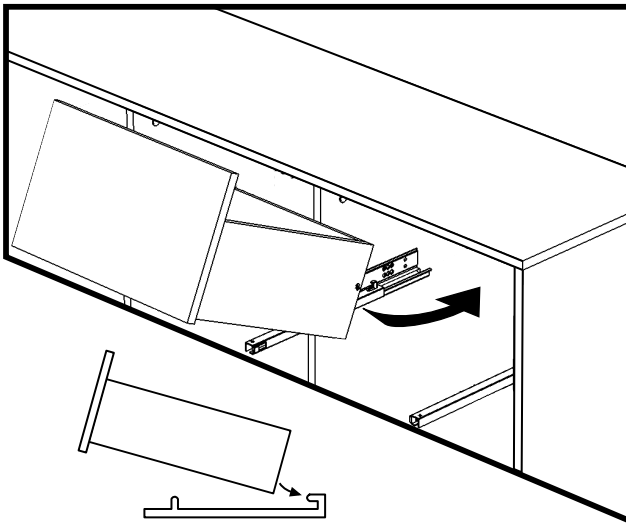

26

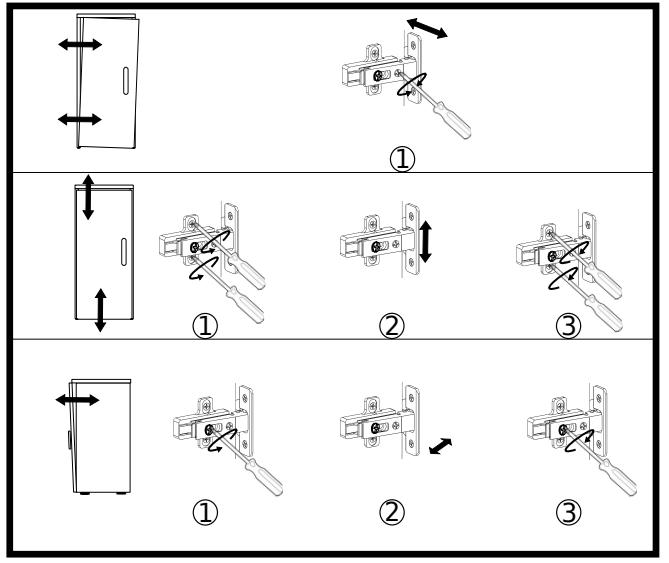
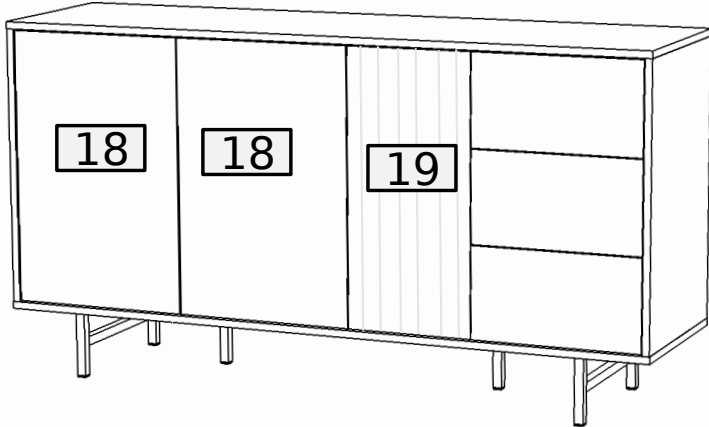
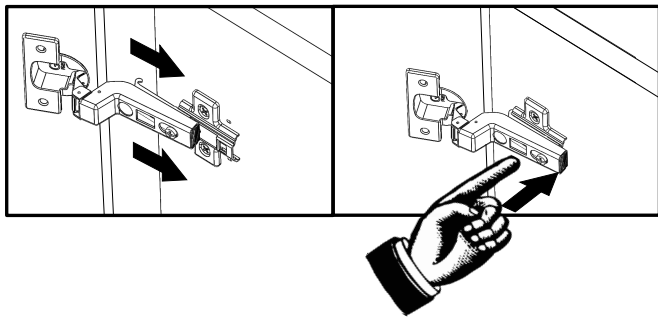
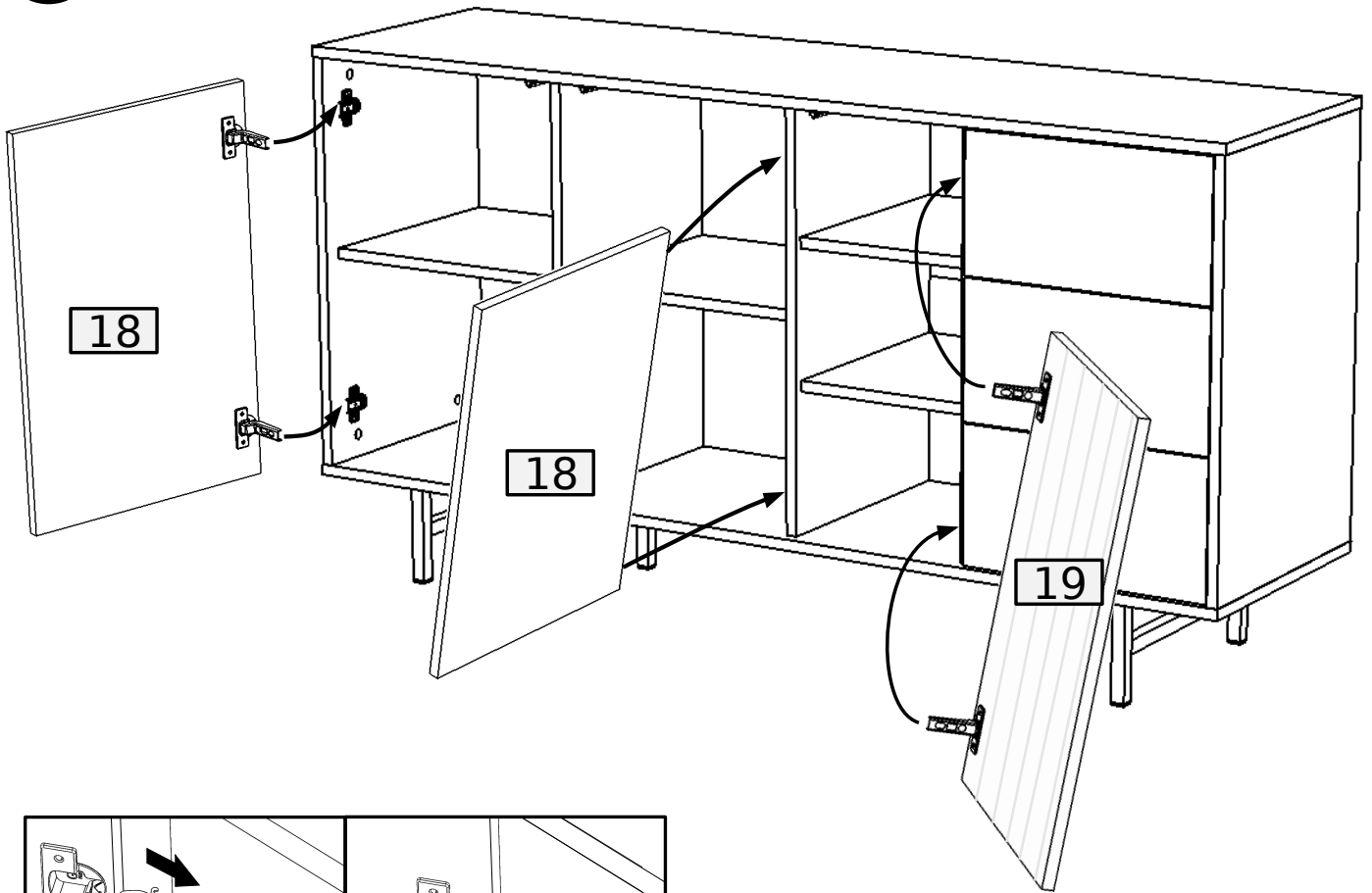

27

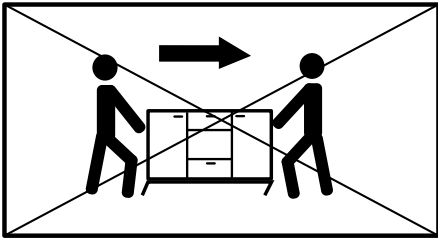
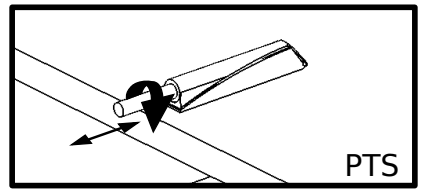
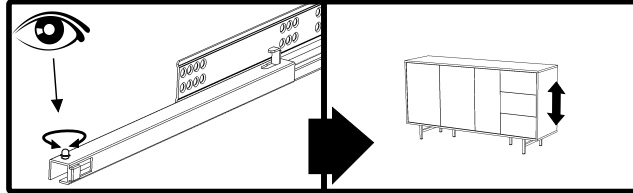
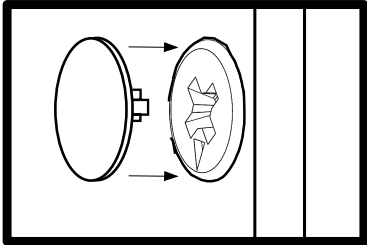
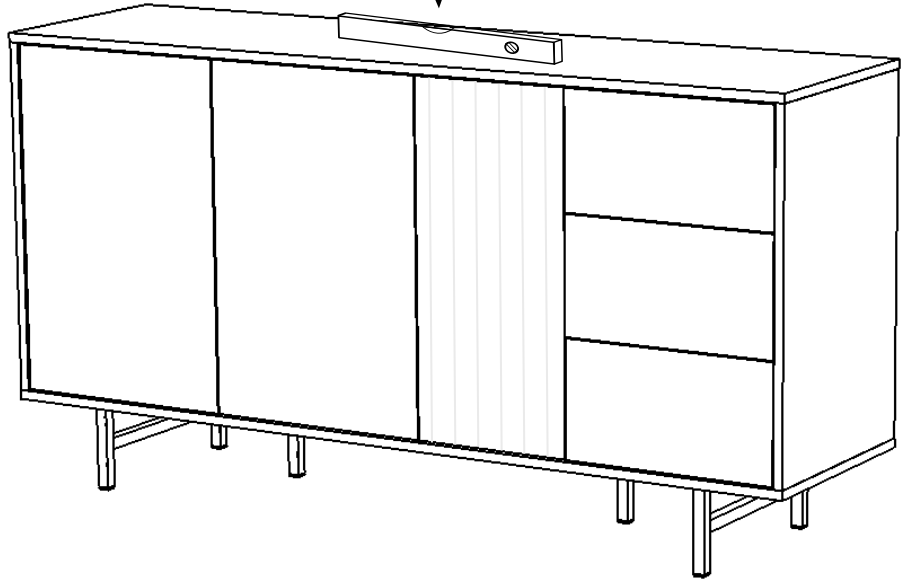
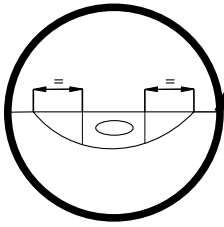

✗

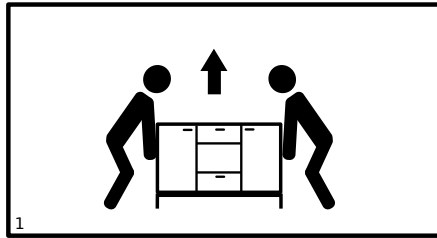

2

✓

