

120, 150, 180

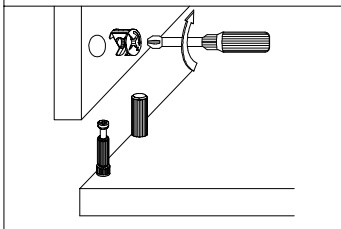

	180	150	120
1	2150 x 581	2000 x 581	2000 x 581
2	2150 x 581	2000 x 581	2000 x 581
3	1768 x 581	1468 x 581	1168 x 581
4	1768 x 565	1468 x 565	1168 x 565
5	1644 x 475	1494 x 475	1494 x 475
6	1768 x 475	1468 x 475	1168 x 475
7	876 x 475	726 x 475	576 x 475
7A	876 x 475	726 x 475	575 x 475
8	357 x 475	357 x 475	357 x 475
9	1768 x 100	1468 x 100	1168 x 100
10	1768 x 72	1468 x 72	1168 x 72
11	2000 x 940	1859 x 750	1859 x 600
12	2040 x 900	1895 x 748	1895 x 598

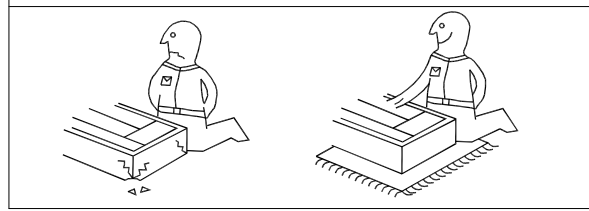
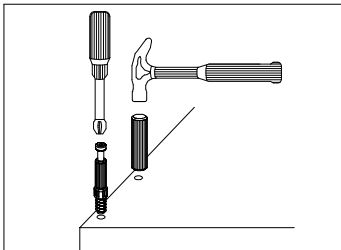
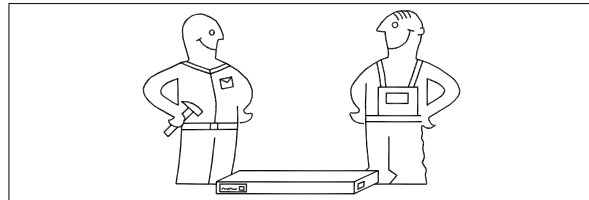
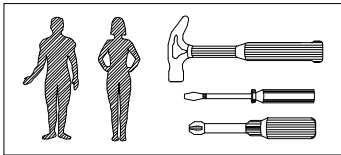
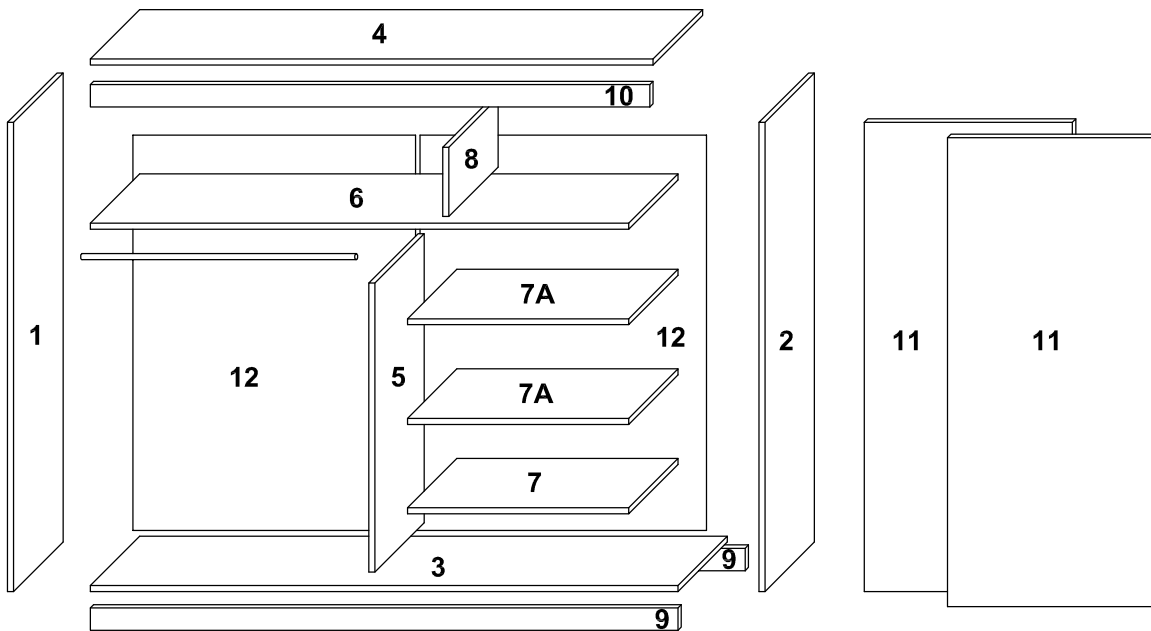
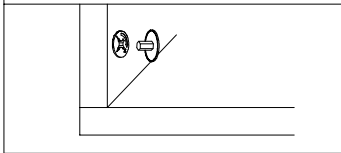
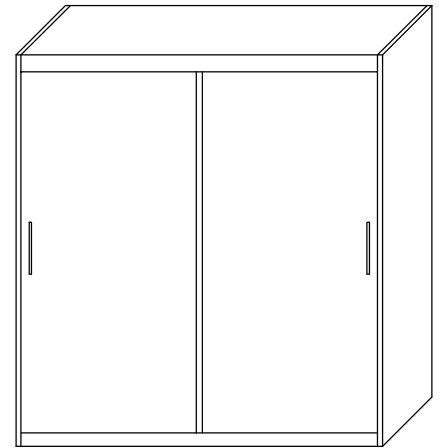

28   A	28   B	28   C	38   D	8   E	10   F		
2   G	4   H	1   I	2   J	4   K	L	M	N

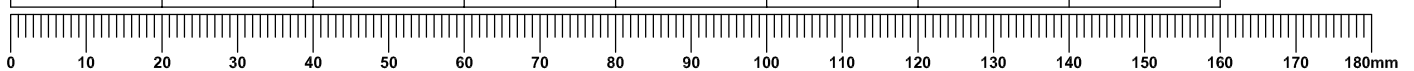

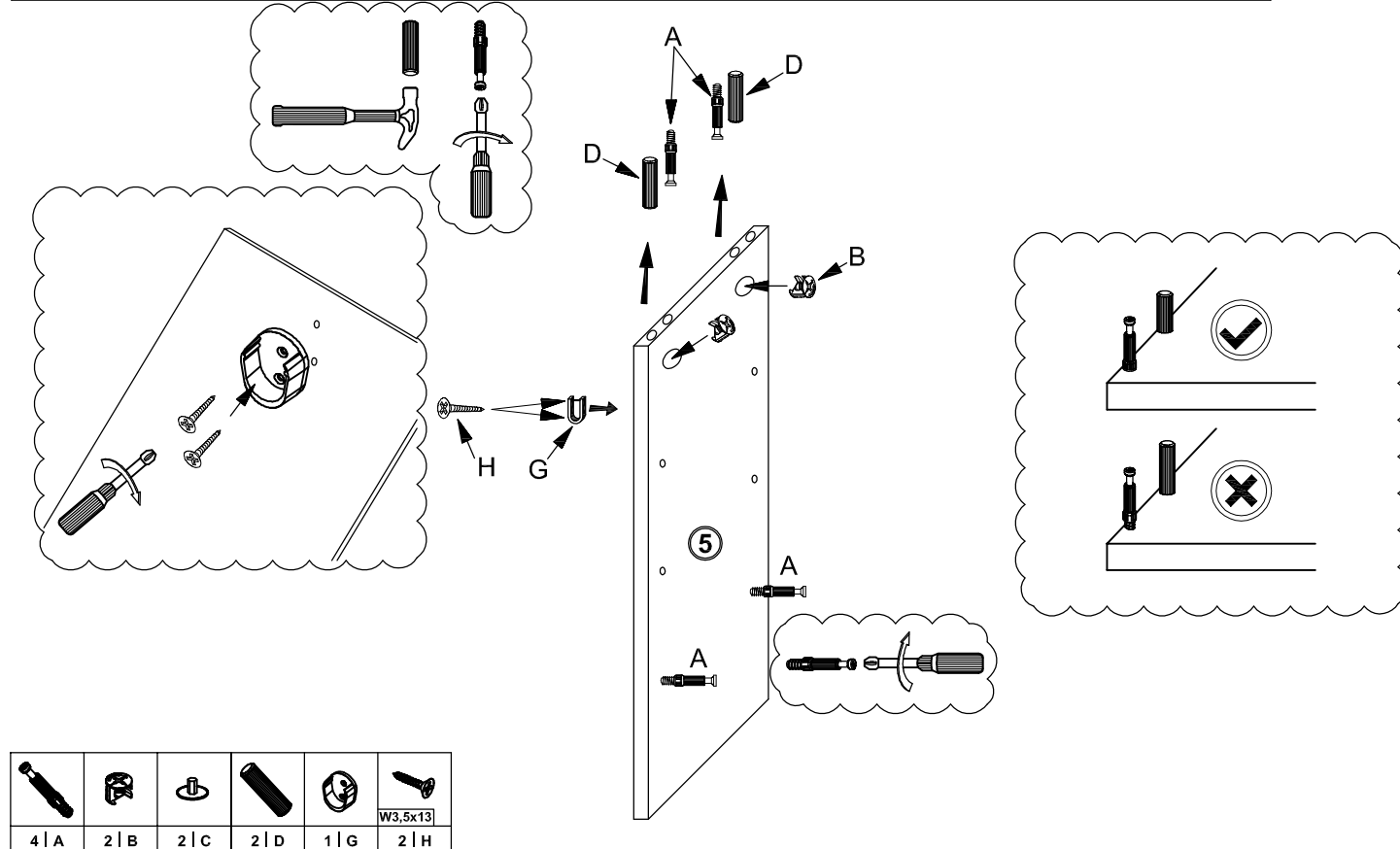
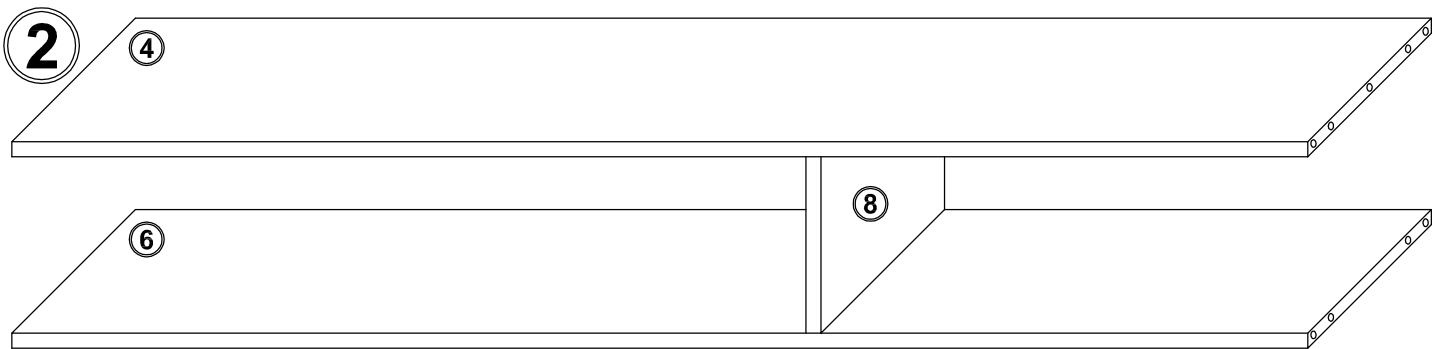
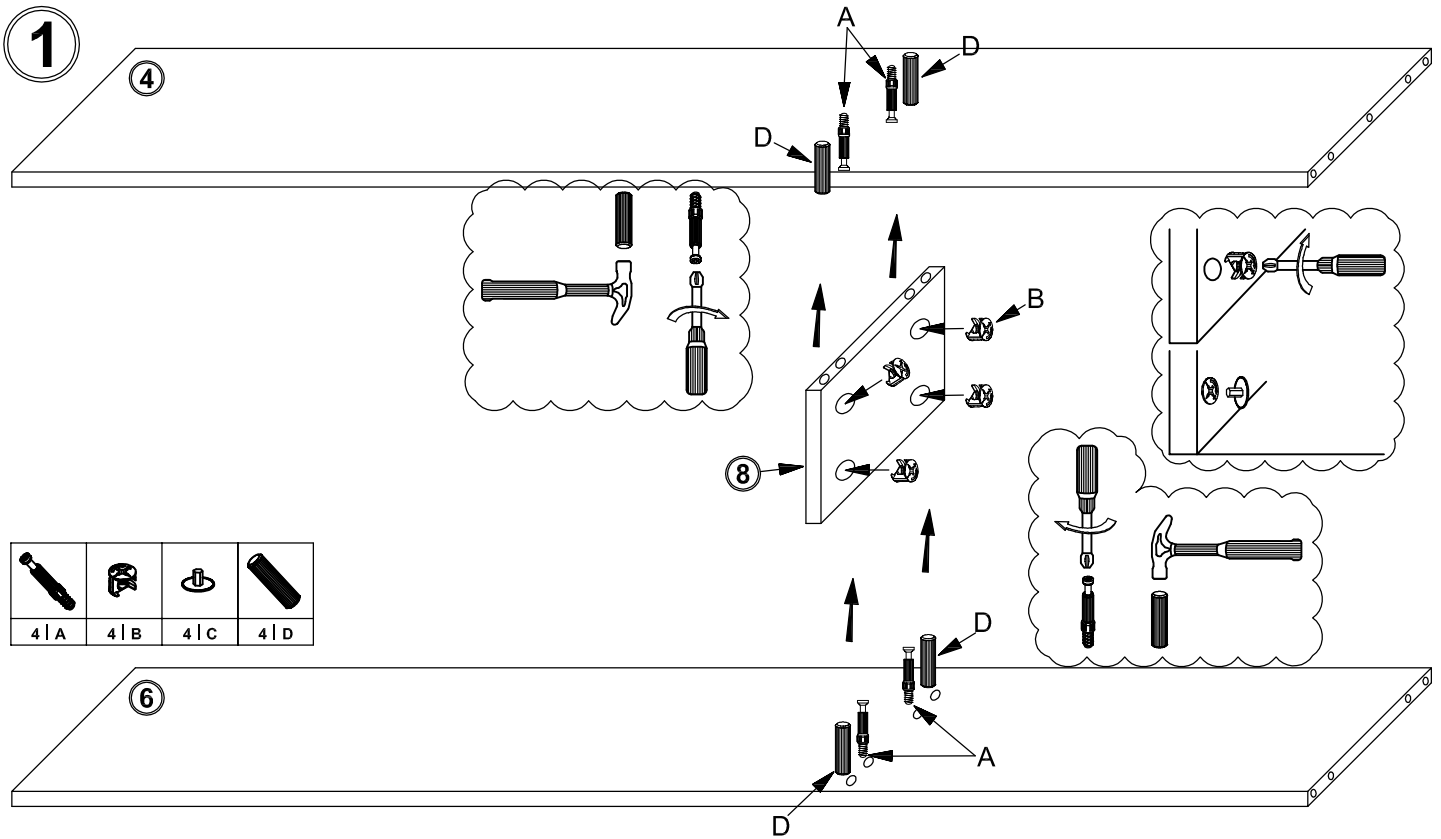

3



4

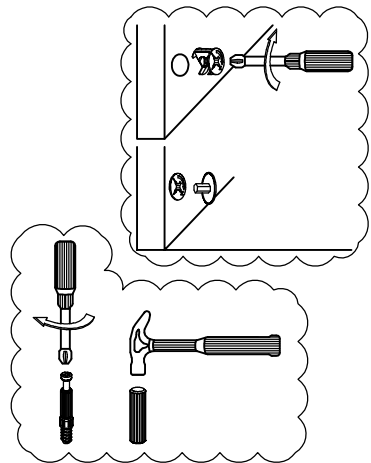
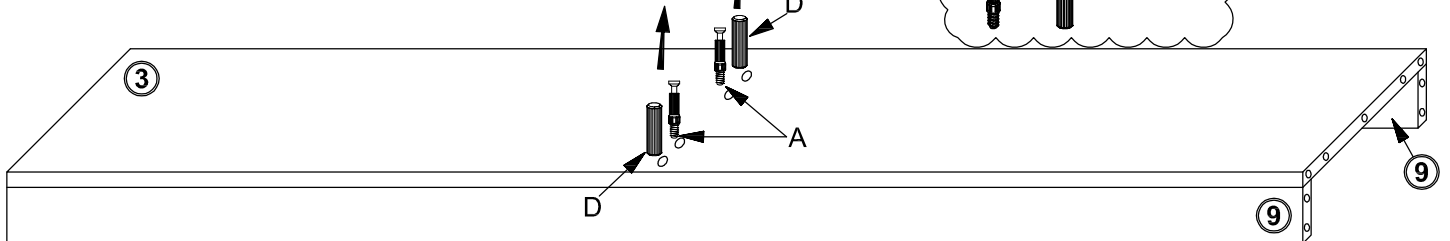

5



		
2   B	2   C	4   E



6

4

6

8

1

5

7

2

3

9

9

4   E	4   F					
						W3,5x13
14   A	14   B	14   C	24   D	1   G	2   H	

7

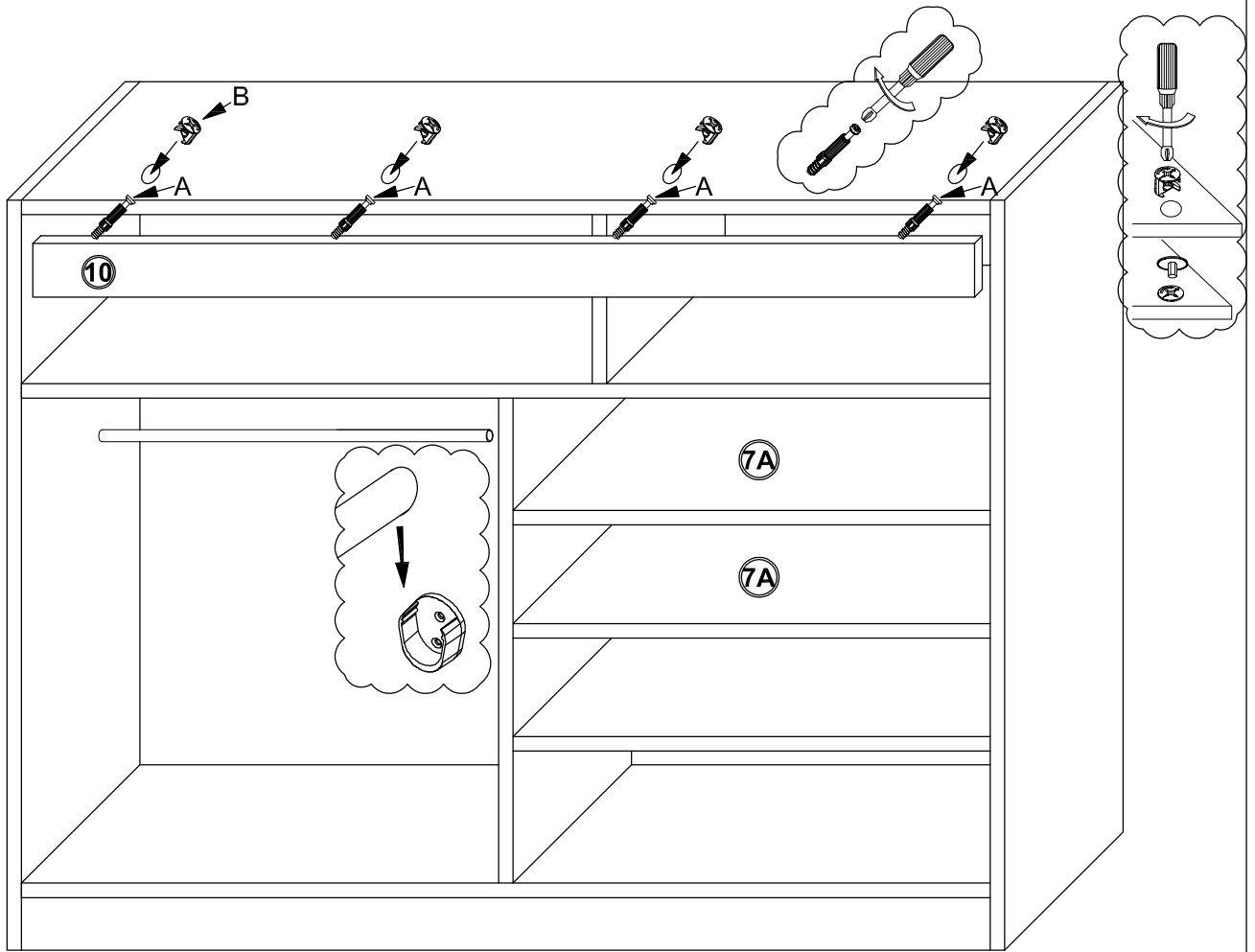

$A = B$

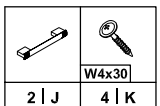
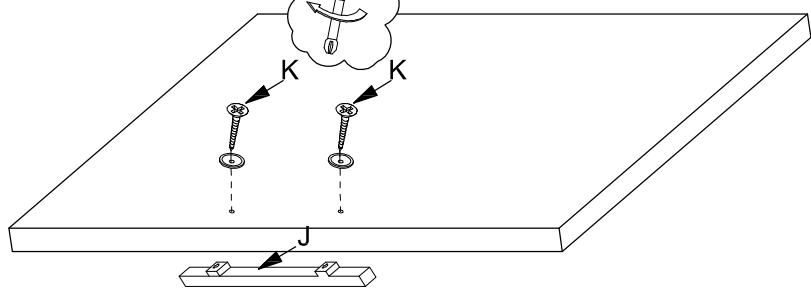
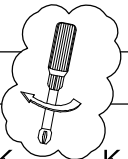
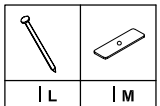
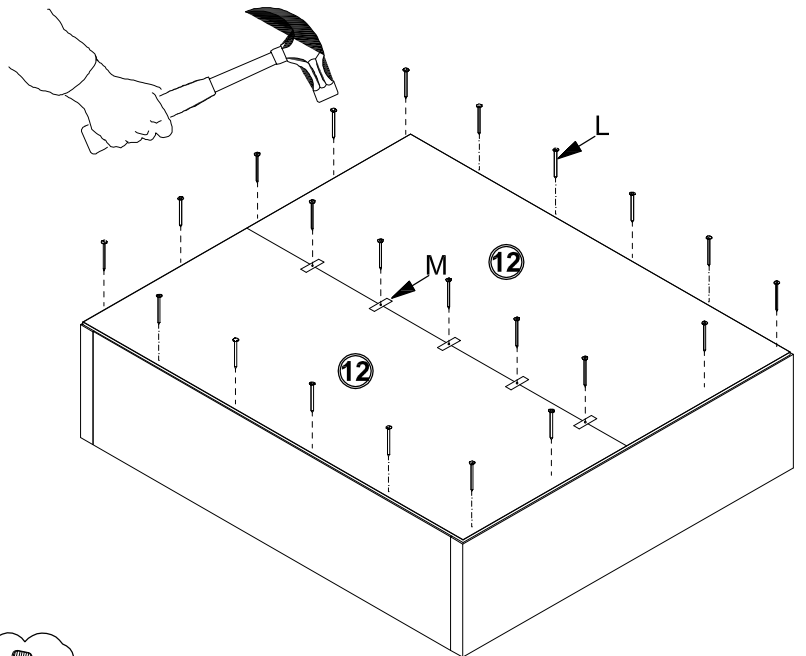
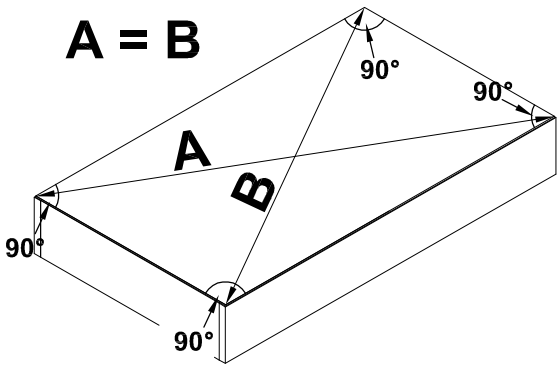

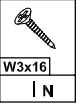

Szafa 120, 150

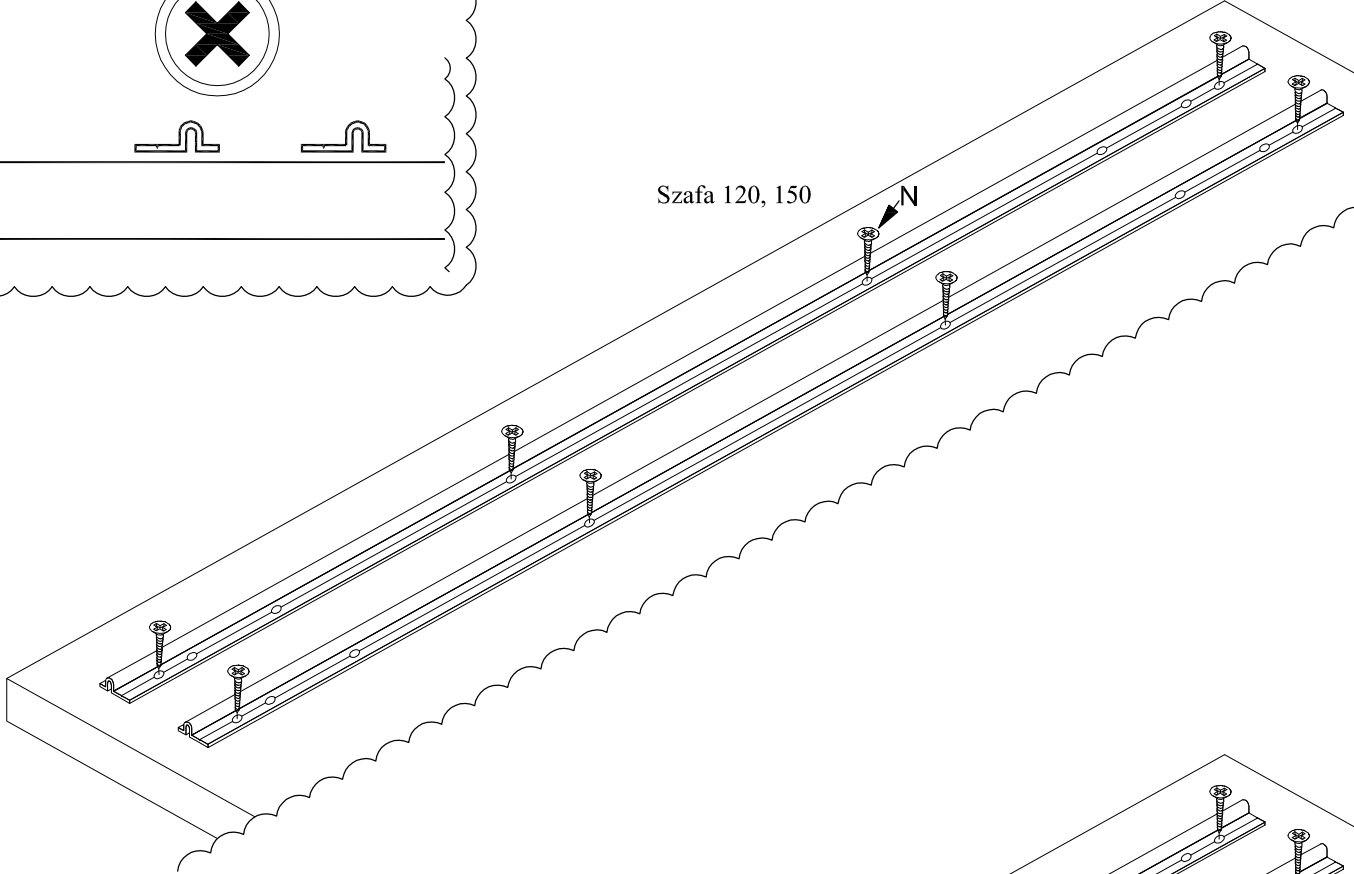

Szafa 180

