

# FALCO

## FK100

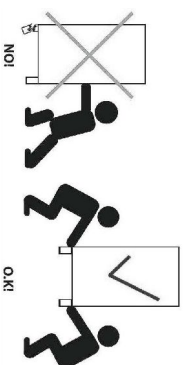
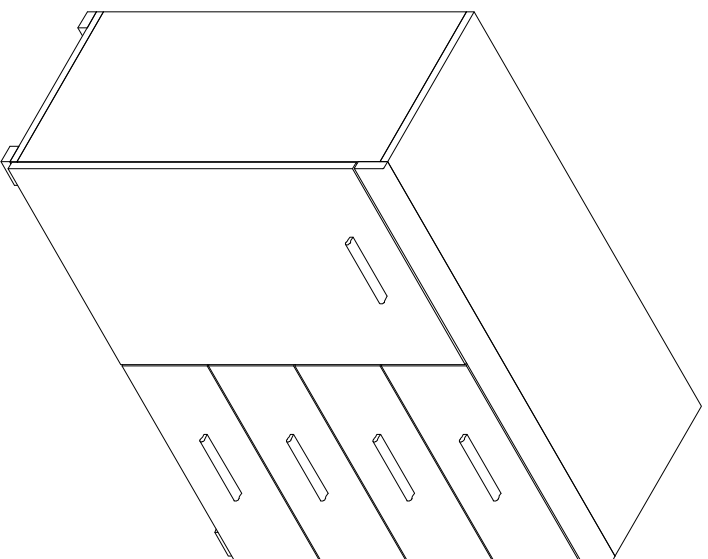

6.6.2017

- D** Montageanleitung
- FR** Notice de montage
- NL** Handleiding voor de montage
- CZ** Montážní návod
- HU** Szerelési útmutató
- TR** Montaj talimatı
- GB** Assembly Instructions
- IT** Istruzioni di montaggio
- PL** Instrukcja montażu
- SK** Návod na montáž
- RO** Instrucțiunile de montaj
- RU** Инструкции по монтажу

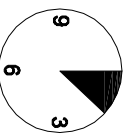
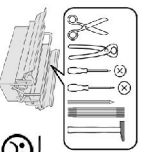

20 min.

1

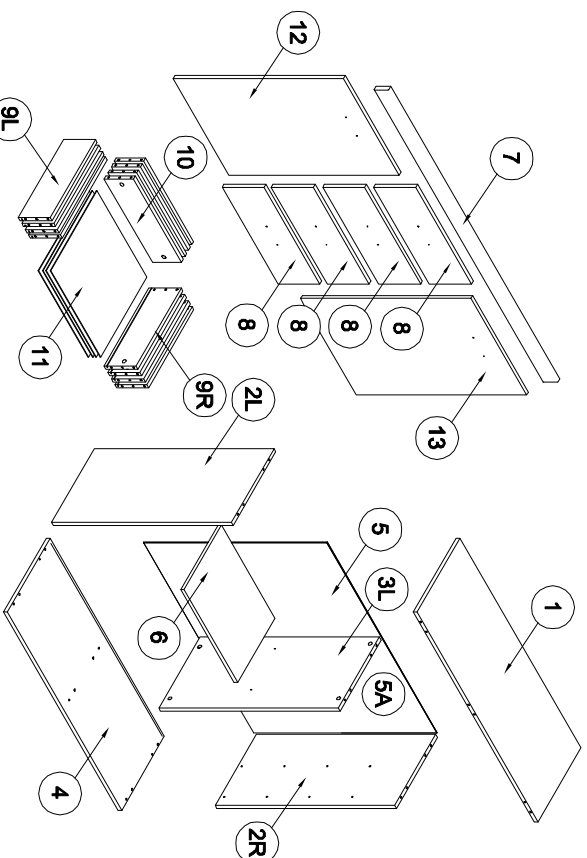

<b>ZC</b> x5	<b>Y</b> x5	<b>W</b> x5	<b>YA</b> x10	<b>PC</b> x2	<b>NA</b> x4	<b>ND</b> x24	<b>C</b> x31	<b>Z</b> x29
<b>B</b> x31	<b>A</b> x47	<b>RPS</b> x4	<b>RC</b> x2	<b>H</b> x4	<b>NB</b> x24	<b>N</b> x21	<b>Z</b> x8	
<b>6x32</b>	<b>360</b>	<b>4x27</b>	<b>6.5x13</b>	<b>3.5x13</b>	<b>3x20</b>			

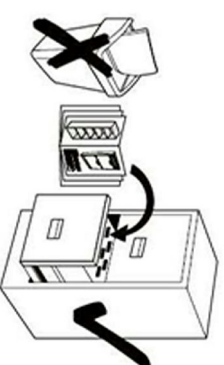
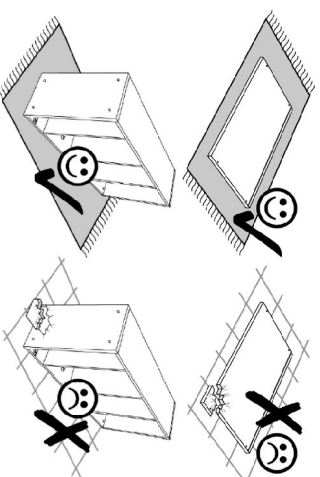

2

3

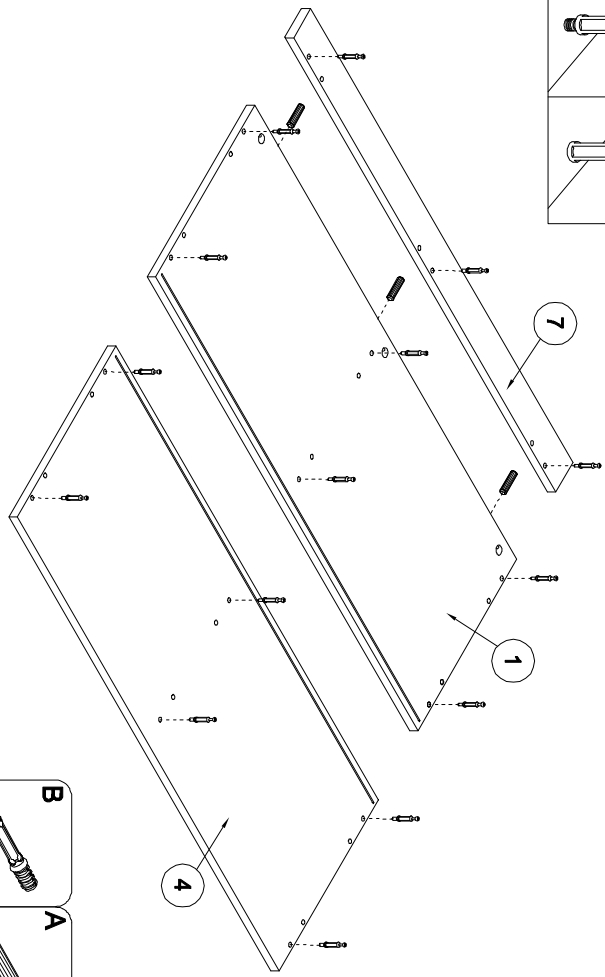
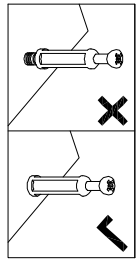

- B** x15
- A** 8x32 x3

4

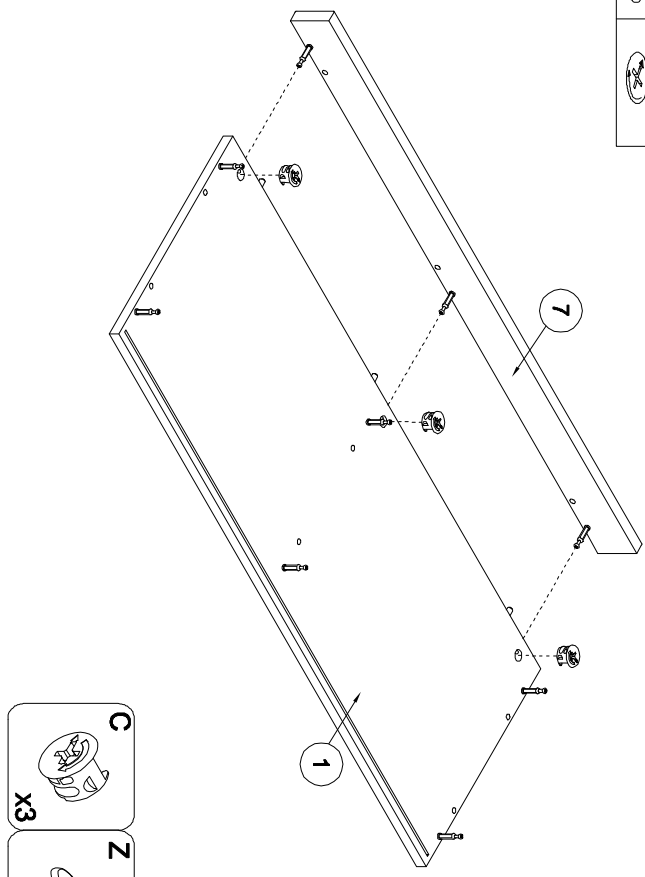
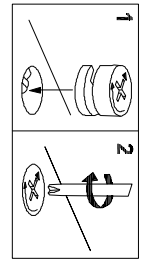

- C** x3
- Z** x3

5

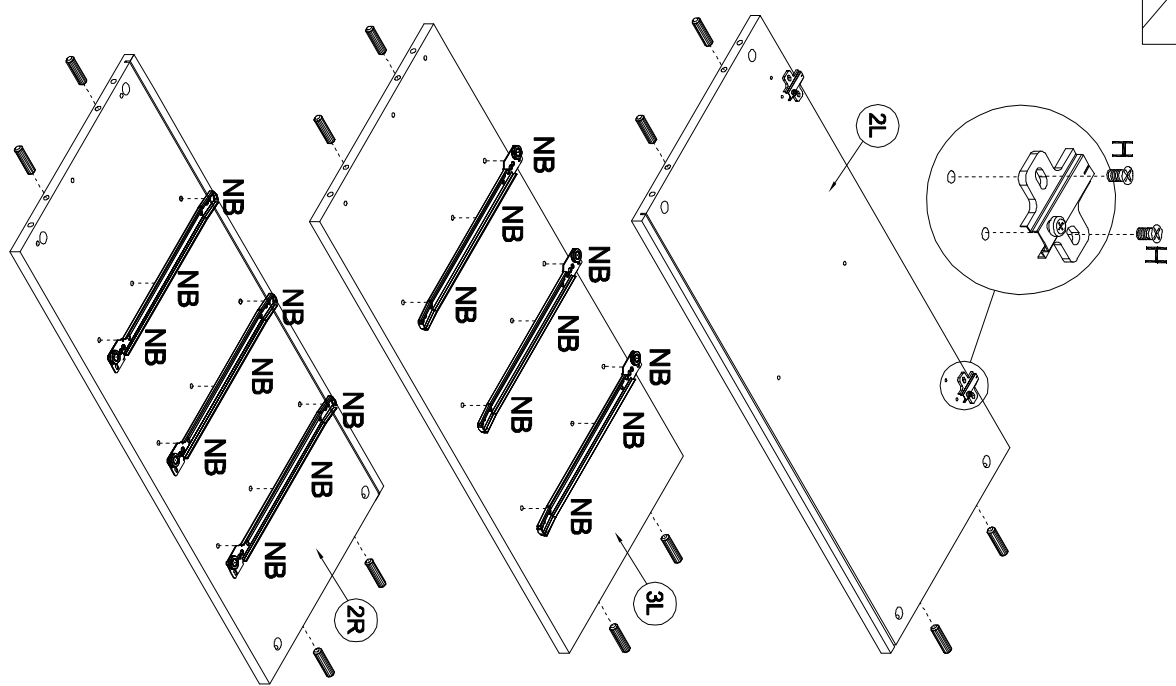
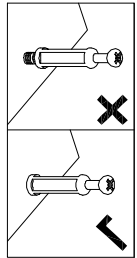

- RPS** 360 x3
- A** 8x32 x3
- RC** x12
- H** 6.5x13 x2
- NB** 3.5x13 x4
- NB** 3.5x13 x18

6

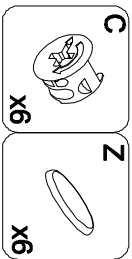
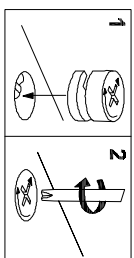
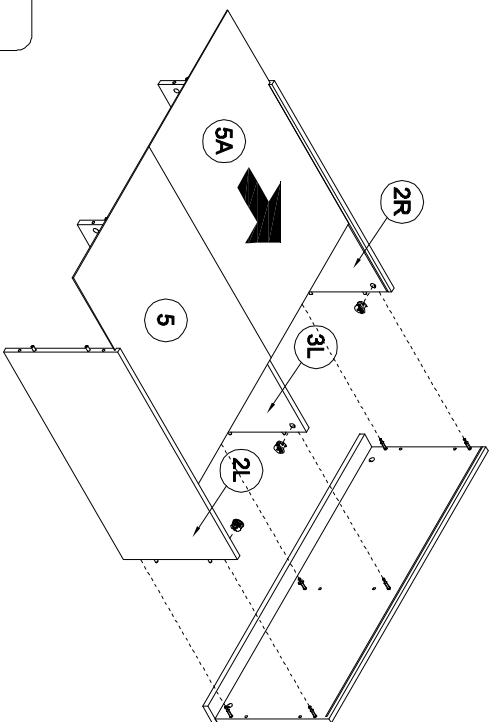

8

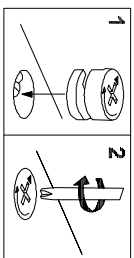
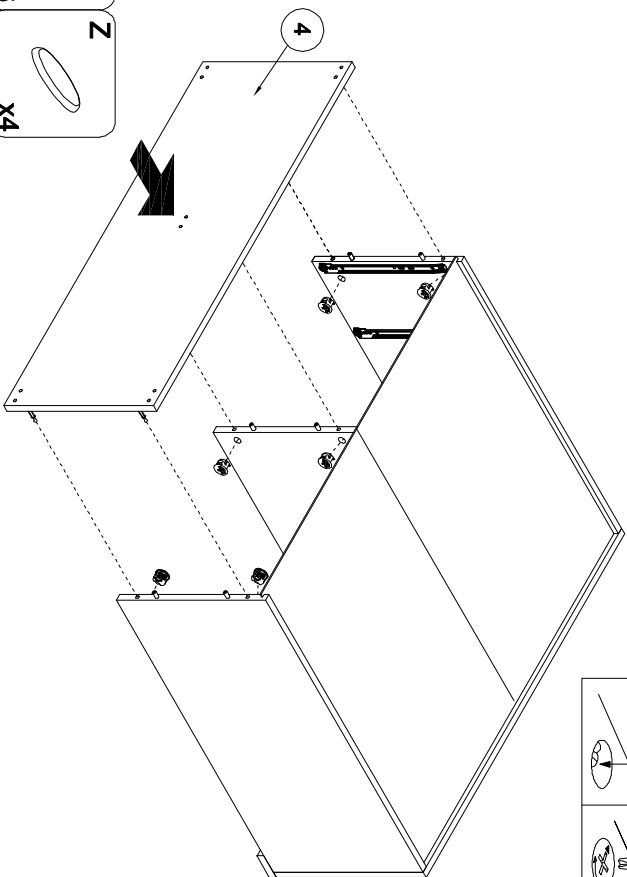

1

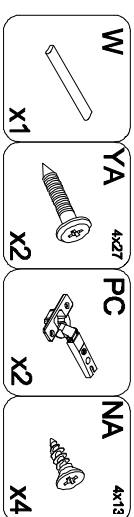
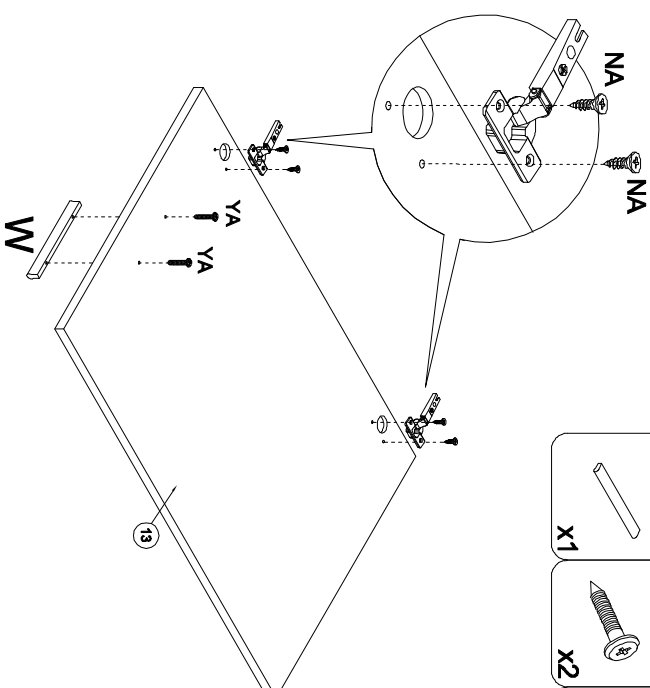
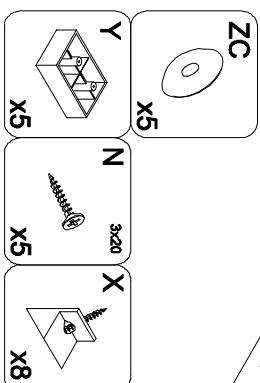
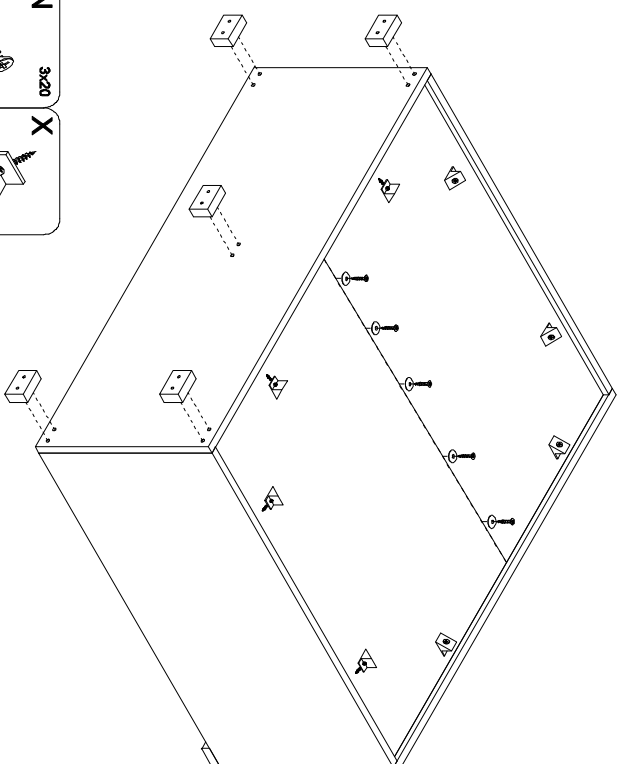

9

10

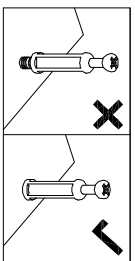
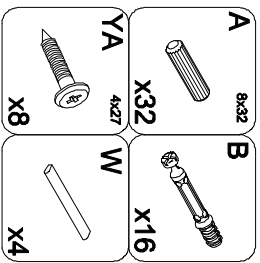
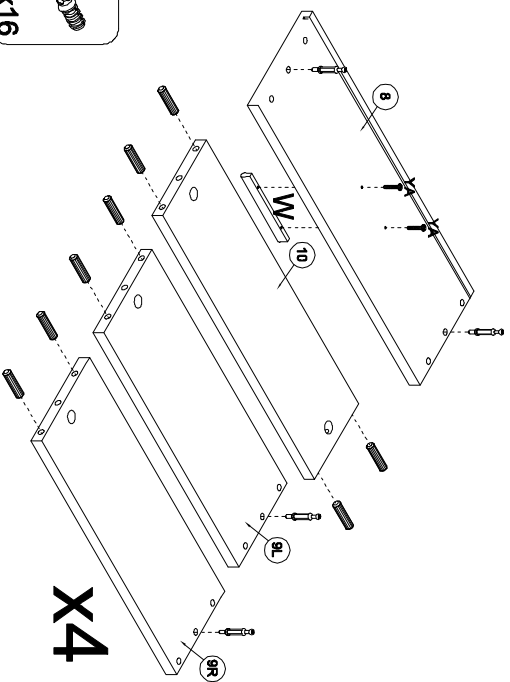

X4

12

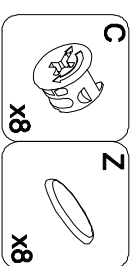
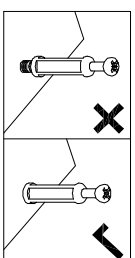
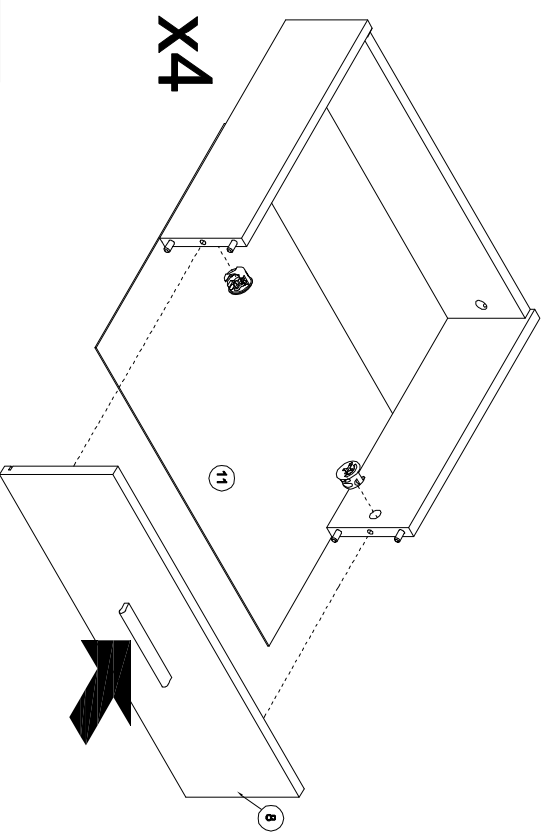

X4

11

13

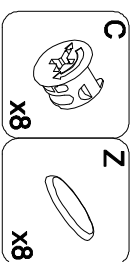
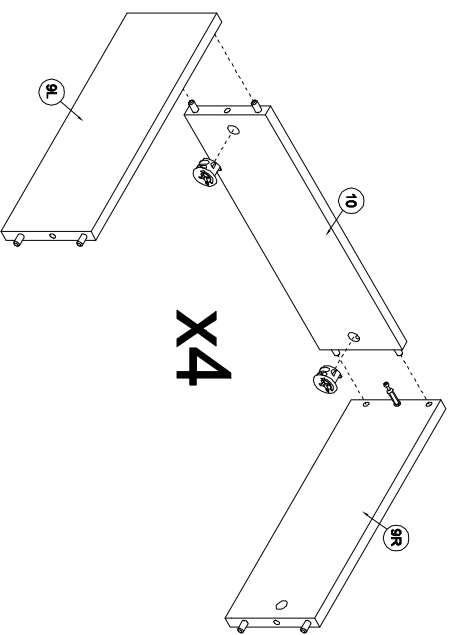

X4

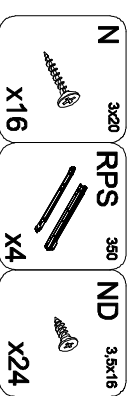
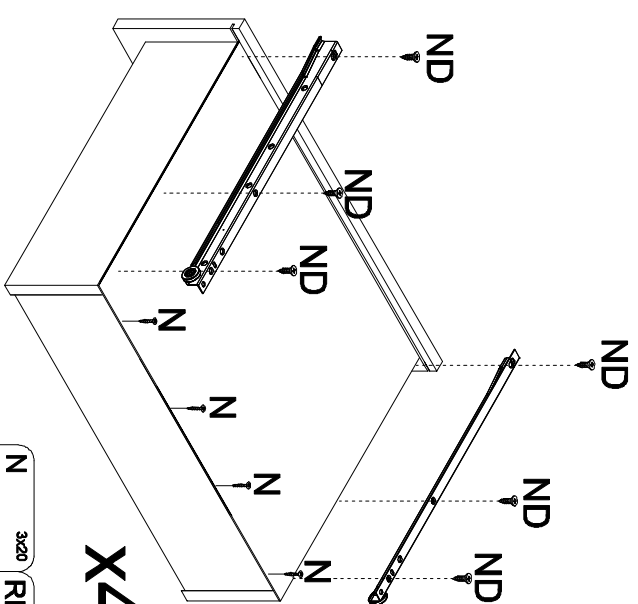

X4

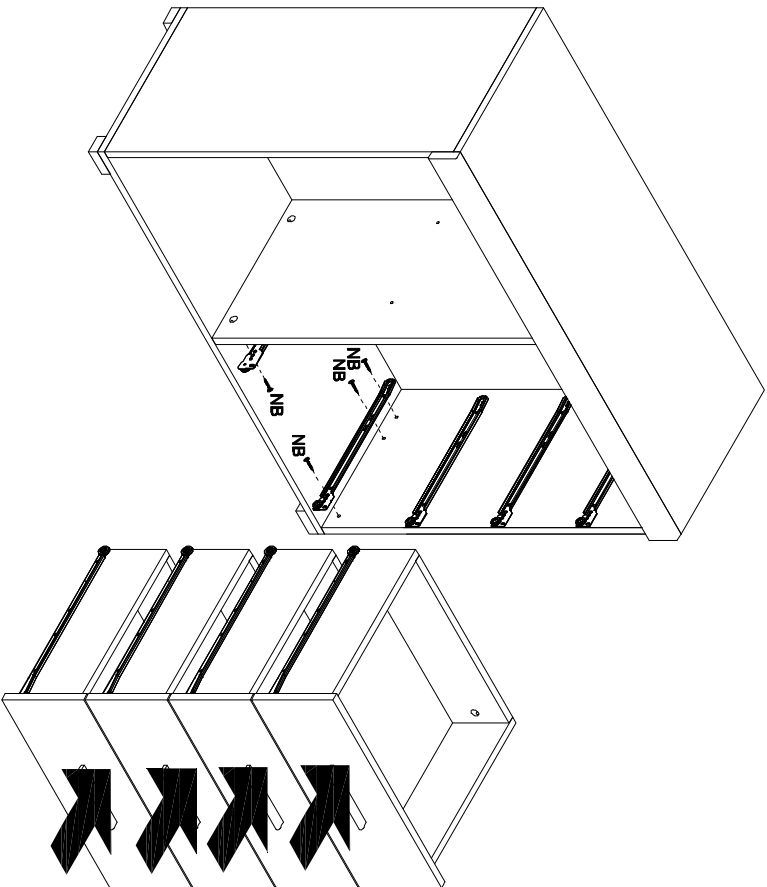

- NB
3,5x113
x6
- RPS
360
x1

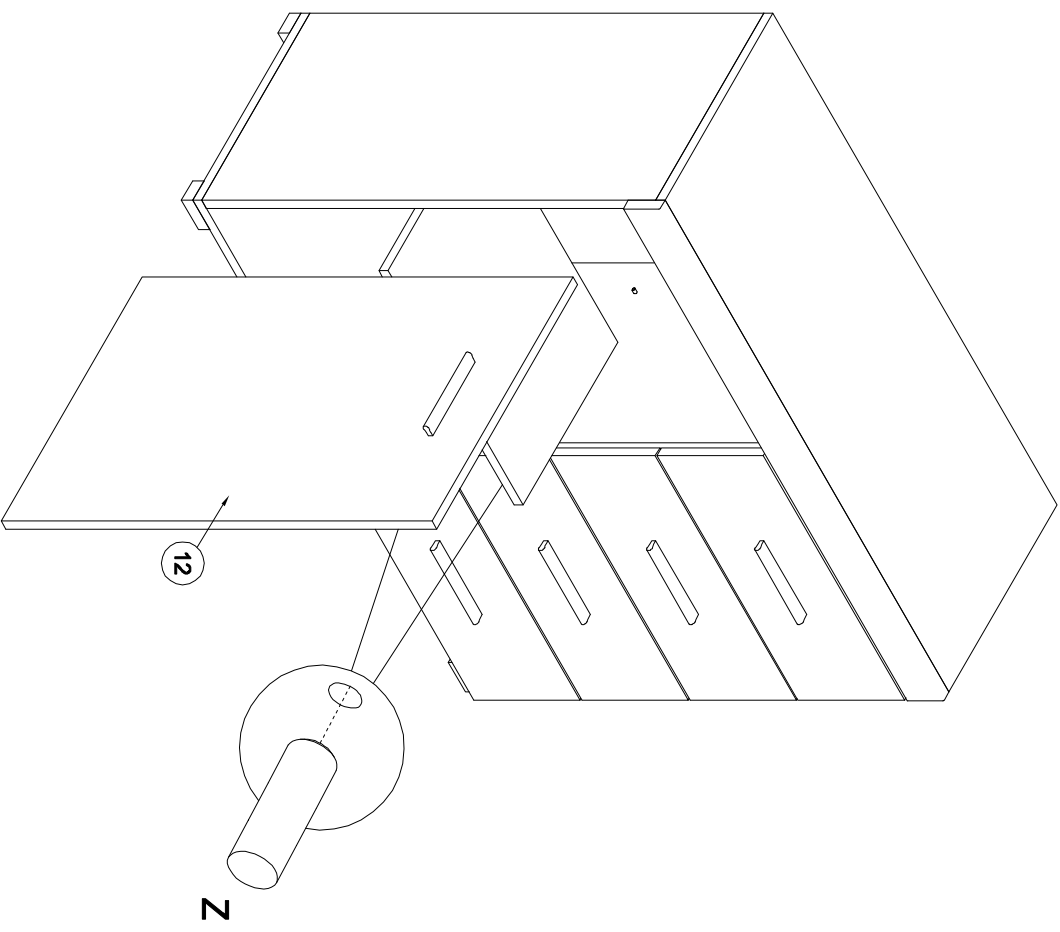
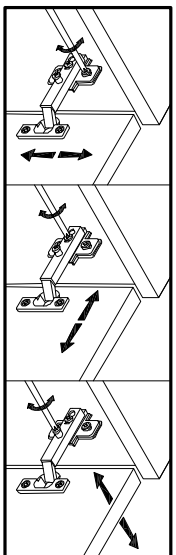

- Z
x4